

VRF

Technical Data Book

DVM S Outdoor Units for Turkey & CIS & Indonesia
(R410A, 50Hz, H/P, H/R)

SAMSUNG

History

Version	Modification	Date	Remark
Ver.1.0	Released DVM S H/P, H/R TDB (include AM9000H)	15.02.27	
Ver.1.1	Update sound pressure & power data	15.04.22	
Ver.1.2	Error modification: Size, air flow rate, comp output for combination units (in Specifiation)	15.07.09	
Ver.1.3	Modify MCA/MFA	16.03.17	
Ver.1.4	Modify the specifications of ODU(8HP, 10HP, 12HP) weight	16.04.06	
Ver.1.5	Fan External Static Pressure Max. : 78.40 → 78.45 Piping Connections Installation Limitation Max. Height :110(40)→110(110) Compressor Model Name DS-GB052FAVASG → DS GB052FAVBSG	16.10.17	
Ver.1.6	Modify MCA/MFA Table (in Installation part, P72~73)	16.11.02	

Nomenclature

Outdoor Units

Model Names

AM

(1)

260

(2)

H

(3)

X

(4)

V

(5)

A

(6)

G

(7)

H

(8)

/

TK

Buyer

(1) Classification

AM	VRF
----	-----

(2) Capacity

x 1/10 HP (3 digits)

(3) Version

E	2012
F	2013
H	2014

(4) Product Type

X	Outdoor Unit
N	Indoor Unit

(5) Feature1

V	Inverter
M	DVM S Eco

(6) Feature2

A	Standard + General Temp.+ MODULE
---	----------------------------------



















(7) Rating Voltage

E	1Ø, 220~240V, 50Hz
G	3Ø, 380~415V, 50Hz



(8) Mode

H	Heat Pump
R	Heat Recovery

Accessory

Classification	Product	Image	Model	Remark
Integrated Management System	DMS 2.0		MIM-D00AN	-
	S-NET 3		MST-P3P	-
	PIM		MIM-B16N	-
Building Management System	BACnet Gateway		MIM-B17N	-
	LonWorks Gateway		MIM-B18N	-
Centralized Control System	On/Off controller		MCM-A202DN	-
	Touch controller		MCM-A300N	-
Individual Control System	Wireless remote controller		MR-EH00	-
	Wired remote controller		MWR-WE10N (Multi function)	A/C+VTL
			MWR-WW00N	DVM S Hydro Unit
	Simplified wired remote controller		MWR-SH00N	-
			MWR-VH02	ERV
Others	Operation mode selection switch		MCM-C200	DVM S Series (Except HR Models)
	External room sensor		MRW-TA	Cassette, Wall-mount, Ceiling, Duct, Console
			MRW-TS	Duct S
	Compatible interface module		MIM-N01	Nasa-No Nasa
	ERV interface module		MIM-N10	ERV (Nasa)
	External contact interface module		MIM-B14	-
	S-Converter		MIM-C02N	-
	MTFC (Multi tenant function controller)		MCM-C210N	-
	Wireless signal receiver		MRK-A10N	-

Accessory

Product	Image	Model	Remark
Y-Joint		MXJ-YA1509M	15.0 kW and below
		MXJ-YA2512M	Over 15.0 kW~40.0 kW and below
		MXJ-YA2812M	Over 40.0 kW~45.0 kW and below
		MXJ-YA2815M	Over 45.0 kW~70.3 kW and below
		MXJ-YA3419M	Over 70.3 kW~98.4 kW and below
		MXJ-YA4119M	Over 98.4 kW~135.2 kW and below
		MXJ-YA4422M	Over 135.2 kW
Y-Joint (Only H/R)		MXJ-YA1500M	22.4 kW and below
		MXJ-YA2500M	Over 22.4 kW~70.3 kW and below
		MXJ-YA3100M	Over 70.3 kW~135.2 kW and below
		MXJ-YA3800M	Over 135.2 kW
Y-Joint Outdoor unit		MXJ-TA3419M	135.2 kW and below
		MXJ-TA4122M	140.2 kW and Over
Y-Joint (Only H/R) Outdoor unit		MXJ-TA3100M	135.2 kW and below
		MXJ-TA3800M	140.2 kW and Over
Distribution Header		MXJ-HA2512M	45.0 kW and below (for 4 rooms)
		MXJ-HA3115M	70.3 kW and below (for 8 rooms)
		MXJ-HA3819M	Over 70.3 kW~135.2 kW and below(for 8 rooms)
EEV KIT		MEV-E24SA	1 Indoor
		MEV-E32SA	
		MXD-E24K132A	2 Indoor
		MXD-E24K200A	
		MXD-E32K200A	
		MXD-E24K232A	3 Indoor
		MXD-E24K300A	
		MXD-E32K224A	
MXD-E32K300A			
AHU KIT		MXD-K025AN	7.0kW~8.75kW
		MXD-K050AN	14.0kW~17.5kW
		MXD-K075AN	21.0kW~26.25kW
		MXD-K100AN	28.0kW~35.0kW

Accessory

Product	Image	Model	Remark
PDM KIT		MXD-A38K2A	8~12HP
		MXD-A12K2A	14~16HP
		MXD-A58K2A	18~26HP
S-Plasma Ion KIT		MSD-CAN1	4Way Cassette S 4Way Cassette S(600x600)
		MSD-EAN1	ERV-Plus
Motion detect Sensor		MCR-SMA	4Way Cassette S (600x600)
ERV CO2 Sensor		MOS-C1	ERV, ERV PLUS
Drain Pump		MDP-N047SNC0D	OAP Duct (14.0 kW)
		MDP-N047SNC1D	HSP Duct (22.0 / 28.0 kW) OAP Duct (22.4 / 28.0 kW)
		MDP-M075SGU1D	MSP Duct (9.0 / 11.2 kW)
		MDP-M075SGU2D	MSP Duct (12.8 / 14.0 kW) HSP Duct (11.2 / 12.8 / 14.0 kW)
		MDP-M075SGU3D	MSP Duct (5.6 / 7.1 kW)
		MDP-E075SEE3D	Slim Duct (2.0~14.0 kW)
		MDP-G075SP	Duct S (External, All Capacities)
		MDP-G075SQ	Duct S (Internal, 3.5 kW~14 kW)
Humidifier		MVO-VA050100	500CMH (ERV Plus)
		MVO-VA100100	1000CMH (ERV Plus)
Panel		PC1NUSMAN	Slim 1Way Cassette
		PC1NUPMAN	Slim 1Way Cassette (Z-sliding)
		PC1MWSKAN	1Way Cassette (1.7 kW, 2.2 kW)
		PC2NUSMEN	2Way cassette
		PC4SUSMAN	4Way Cassette S(600x600) (Waffle)
		PC4SUSMEN	4Way Cassette S(600x600) (Classic)
		PC4NUSKAN	4 Way cassette S (Waffle)
		PC4NUSKEN	4 Way cassette S (Classic)
		PC4NBSKAN	4 Way cassette S (Waffle, Black)

Outdoor

1 Line-up

2 Specifications

3 Operation limit

4 Dimensional drawing

5 Electrical wiring diagram

6 Sound pressure level

7 Sound power level

8 Cycle diagram

9 Installation

1 Line-up

Heat Pump (Standard)

Model	AM080FXVA GH/TK	AM100FXVA GH/TK	AM120FXVA GH/TK	AM140FXVA GH/TK	AM160FXVA GH/TK	AM180FXVA GH/TK	AM200FXVA GH/TK	AM220FXVA GH/TK	AM240HXVA GH/TK	AM260HXVA GH/TK
AM080FXVAGH/TK	1									
AM100FXVAGH/TK		1								
AM120FXVAGH/TK			1							
AM140FXVAGH/TK				1						
AM160FXVAGH/TK					1					
AM180FXVAGH/TK						1				
AM200FXVAGH/TK							1			
AM220FXVAGH/TK								1		
AM240HXVAGH/TK									1	
AM260HXVAGH/TK										1
AM280HXVAGH1TK			1		1					
AM300HXVAGH1TK			1			1				
AM320HXVAGH1TK			1				1			
AM340HXVAGH1TK			1					1		
AM360HXVAGH1TK				1				1		
AM380HXVAGH1TK					1			1		
AM400HXVAGH1TK				1						1
AM420HXVAGH1TK							1	1		
AM440HXVAGH1TK								2		
AM460HXVAGH1TK			2					1		
AM480HXVAGH1TK			1	1				1		
AM500HXVAGH1TK			1		1			1		
AM520HXVAGH1TK			1			1		1		
AM540HXVAGH1TK			1				1	1		
AM560HXVAGH1TK			1					2		
AM580HXVAGH1TK				1				2		
AM600HXVAGH1TK					1			2		
AM620HXVAGH1TK						1		2		
AM640HXVAGH1TK							1	2		
AM660HXVAGH1TK								3		
AM680HXVAGH1TK			2					2		
AM700HXVAGH1TK			1	1				2		
AM720HXVAGH1TK			1		1			2		
AM740HXVAGH1TK			1			1		2		
AM760HXVAGH1TK			1				1	2		
AM780HXVAGH1TK			1					3		
AM800HXVAGH1TK				1				3		

1 Line-up

Heat Recovery

Model	AM080FXVAGR/ TK	AM100FXVAGR/ TK	AM120FXVAGR/ TK	AM140FXVAGR/ TK	AM160FXVAGR/ TK	AM180FXVAGR/ TK	AM200FXVAGR/ TK	AM220FXVAGR/ TK
AM080FXVAGR/TK	1							
AM100FXVAGR/TK		1						
AM120FXVAGR/TK			1					
AM140FXVAGR/TK				1				
AM160FXVAGR/TK					1			
AM180FXVAGR/TK						1		
AM200FXVAGR/TK							1	
AM220FXVAGR/TK								1
AM240FXVAGR/TK			2					
AM260FXVAGR/TK			1	1				
AM280FXVAGR/TK			1		1			
AM300FXVAGR/TK			1			1		
AM320FXVAGR/TK			1				1	
AM340FXVAGR/TK			1					1
AM360FXVAGR/TK				1				1
AM380FXVAGR/TK					1			1
AM400FXVAGR/TK							2	
AM420FXVAGR/TK							1	1
AM440FXVAGR/TK								2
AM460FXVAGR/TK			2					1
AM480FXVAGR/TK			1	1				1
AM500FXVAGR/TK			1		1			1
AM520FXVAGR/TK			1			1		1
AM540FXVAGR/TK			1				1	1
AM560FXVAGR/TK			1					2
AM580FXVAGR/TK				1				2
AM600FXVAGR/TK					1			2
AM620FXVAGR/TK							2	1
AM640FXVAGR/TK							1	2
AM660FXVAGR/TK								3
AM680FXVAGR/TK			2					2
AM700FXVAGR/TK			1	1				2
AM720FXVAGR/TK			1		1			2
AM740FXVAGR/TK			1			1		2
AM760FXVAGR/TK			1				1	2
AM780FXVAGR/TK			1					3
AM800FXVAGR/TK				1				3

2 Specifications : Heat Pump (Standard)

Outdoor

Type			DVM S(NEW)	DVM S(NEW)	DVM S(NEW)	DVM S(NEW)	
Model Name			AM080FXVAGH/TK	AM100FXVAGH/TK	AM120FXVAGH/TK	AM140FXVAGH/TK	
Power Supply			Ø, #, V, Hz	3,4,380-415,50	3,4,380-415,50	3,4,380-415,50	
Mode			-	HP	HP	HP	
Performance	Capacity (Nominal)	Cooling	HP	8.00	10.00	12.00	14.00
			kW	22.40	28.00	33.60	40.00
		Heating	Btu/h	76,400	95,500	114,600	136,500
			kW	25.20	31.50	37.80	45.00
Power	Power Input (Nominal)	Cooling 1)	kW	5.00	6.80	8.40	8.90
		Heating 2)	kW	5.10	6.70	8.70	9.50
	Current Input (Nominal)	Cooling 1)	A	8.00	10.90	13.50	14.30
		Heating 2)	A	8.20	10.70	14.00	15.20
	MCA	A	18.00	21.10	25.00	25.00	
	MFA	A	25.00	32.00	32.00	32.00	
COP	EER (Nominal Cooling)		-	4.48	4.12	4.00	4.49
	COP (Nominal Heating)		-	4.94	4.70	4.34	4.74
	Energy Grade		-	ESEER 7.85	ESEER 7.25	ESEER 7.03	ESEER 7.02
			-	-	-	-	-
Compressor	Type		-	SSC Scroll x 1	SSC Scroll x 1	SSC Scroll x 1	SSC Scroll x 1
	Output		kW x n	(4.96)	(6.39)	(6.39)	(6.39)
	Model Name		-	DS-GB052FAVBSGx1	DS-GB066FAVBSGx1	DS-GB066FAVBSGx1	DS-GB066FAVBSGx1
	Oil	Type	-	PVE	PVE	PVE	PVE
Fan	Type		-	Propeller	Propeller	Propeller	Propeller
	Output x n		W	830.0	830.0	830.0	620.0x2
	Air Flow Rate		CMM	170	170	220	255
			l/s	2,833.3	2,833.3	3,666.7	4,250.0
	External Static	Max.	mmAQ	8.00	8.00	8.00	8.00
Pa			78.45	78.45	78.45	78.45	
Piping Connections	Liquid Pipe		Ø, mm	9.52	9.52	12.70	12.70
			Ø, inch	3/8"	3/8"	1/2"	1/2"
	Gas Pipe		Ø, mm	19.05	22.22	28.58	28.58
			Ø, inch	3/4"	7/8"	1 1/8"	1 1/8"
	Discharge Gas Pipe		Ø, mm	-	-	-	-
			Ø, inch	-	-	-	-
	Installation Limitation	Max. Length	m	200 (220)	200 (220)	200 (220)	200 (220)
Max. Height		m	110 (110)	110 (110)	110 (110)	110 (110)	
Field Wiring	Power Source Wire		mm ²	-	-	-	-
	Transmission Cable		mm ²	0.75 ~ 1.50	0.75 ~ 1.50	0.75 ~ 1.50	0.75 ~ 1.50
Refrigerant	Type		-	R410A	R410A	R410A	R410A
	Factory Charging		kg	5.50	5.20	5.50	7.70
Sound	Pressure		dBA	57.00	58.00	62.00	61.00
	Power			77.00	79.00	81.00	81.00
External Dimension	New Weight		kg	184.5	184.5	184.5	235.0
	Shipping Weight		kg	200.5	200.5	200.5	254.0
	Net Dimensions (WxHxD)		mm	880x1,695x765	880x1,695x765	880x1,695x765	1,295x1,695x765
	Shipping Dimensions (WxHxD)		mm	948x1,887x832	948x1,887x832	948x1,887x832	1,363x1,887x832
Operating Temp.	Cooling		°C	-5.0 ~ 48.0	-5.0 ~ 48.0	-5.0 ~ 48.0	-5.0 ~ 48.0
	Heating		°C	-25.0 ~ 24.0	-25.0 ~ 24.0	-25.0 ~ 24.0	-25.0 ~ 24.0

* Specifications may be subject to change without prior notice for product improvement.

1) Nominal cooling capacities are based on;

- Indoor temperature : 27°C DB, 19°C WB

- Outdoor temperature : 35°C DB, 24°C WB, Equivalent refrigerant piping : 7.5m, Level differences : 0m

2) Nominal heating capacities are based on;

- Indoor temperature : 20°C DB, 15°C WB

- Outdoor temperature : 7°C DB, 6°C WB, Equivalent refrigerant piping : 7.5m, Level differences : 0m

3) Sound pressure was acquired in an anechoic room. Thus actual noise level may be different depending on the installation conditions.

4) If outdoor unit is located in a higher position than indoor unit, level difference is 110m or under.

(If the level difference is higher than 50m, make a decision by PDM kit installation Guide software whether the PDM kit should be installed or not.)

*PDM kit: Pressure Drop Modulation kit

2 Specifications : Heat Pump (Standard)

Outdoor

Type			DVM S(NEW)	DVM S(NEW)	DVM S(NEW)	DVM S(NEW)	
Model Name			AM160FXVAGH/TK	AM180FXVAGH/TK	AM200FXVAGH/TK	AM220FXVAGH/TK	
Power Supply		Ø, #, V, Hz	3,4,380-415,50	3,4,380-415,50	3,4,380-415,50	3,4,380-415,50	
Mode			-	HP	HP	HP	
Performance	HP		HP	16.00	18.00	20.00	22.00
		Capacity (Nominal)	Cooling	kW	45.00	50.40	56.00
	Btu/h			153,500	172,000	191,100	210,200
		Heating	kW	50.40	56.70	63.00	69.31
Btu/h			172,000	193,500	215,000	236,500	
Power	Power Input (Nominal)	Cooling 1)	kW	11.00	12.88	15.19	17.35
		Heating 2)	kW	11.50	11.90	13.90	16.70
	Current Input (Nominal)	Cooling 1)	A	17.60	20.70	24.40	27.80
		Heating 2)	A	18.40	19.10	22.30	26.80
	MCA	A	32.00	39.10	42.50	44.50	
MFA	A	40.00	50.00	63.00	63.00		
COP	EER (Nominal Cooling)		-	4.09	3.91	3.69	3.55
	COP (Nominal Heating)		-	4.38	4.76	4.53	4.15
	Energy Grade	-	ESEER 6.78	ESEER 6.59	ESEER 6.56	ESEER 6.25	
		-	-	-	-	-	
Compressor	Type		-	SSC Scroll x 2	SSC Scroll x 2	SSC Scroll x 2	SSC Scroll x 2
	Output		kW x n	(4.96 x 2)	(6.39 x 2)	(6.39 x 2)	(6.39 x 2)
	Model Name		-	DS-GB052FAVBSGx2	DS-GB066FAVBSGx2	DS-GB066FAVBSGx2	DS-GB066FAVBSGx2
	Oil	Type	-	PVE	PVE	PVE	PVE
Fan	Type		-	Propeller	Propeller	Propeller	Propeller
	Output x n		W	620.0x2	620.0x2	620.0x2	620.0x2
	Air Flow Rate		CMM	255	290	290	290
			l/s	4,250.0	4,833.3	4,833.3	4,833.3
	External Static	Max.	mmAQ	8.00	8.00	8.00	8.00
Pa			78.45	78.45	78.45	78.45	
Piping Connections	Liquid Pipe		Ø, mm	12.70	15.88	15.88	15.88
			Ø, inch	1/2"	5/8"	5/8"	5/8"
	Gas Pipe		Ø, mm	28.58	28.58	28.58	28.58
			Ø, inch	1 1/8"	1 1/8"	1 1/8"	1 1/8"
	Discharge Gas Pipe		Ø, mm	-	-	-	-
			Ø, inch	-	-	-	-
	Installation Limitation	Max. Length	m	200 (220)	200 (220)	200 (220)	200 (220)
Max. Height			m	110 (110)	110 (110)	110 (110)	110 (110)
Field Wiring	Power Source Wire		mm ²	-	-	-	-
	Transmission Cable		mm ²	0.75 ~ 1.50	0.75 ~ 1.50	0.75 ~ 1.50	0.75 ~ 1.50
Refrigerant	Type		-	R410A	R410A	R410A	R410A
	Factory Charging		kg	7.40	8.70	8.40	8.40
Sound	Pressure		dBA	63.00	64.00	65.00	66.00
	Power			83.00	86.00	87.00	89.00
External Dimension	New Weight		kg	278.0	300.0	300.0	300.0
	Shipping Weight		kg	297.0	319.0	319.0	319.0
	Net Dimensions (WxHxD)		mm	1,295x1,695x765	1,295x1,695x765	1,295x1,695x765	1,295x1,695x765
	Shipping Dimensions (WxHxD)		mm	1,363x1,887x832	1,363x1,887x832	1,363x1,887x832	1,363x1,887x832
Operating Temp.	Cooling		°C	-5.0 ~ 48.0	-5.0 ~ 48.0	-5.0 ~ 48.0	-5.0 ~ 48.0
	Heating		°C	-25.0 ~ 24.0	-25.0 ~ 24.0	-25.0 ~ 24.0	-25.0 ~ 24.0

* Specifications may be subject to change without prior notice for product improvement.

1) Nominal cooling capacities are based on;

- Indoor temperature : 27°C DB, 19°C WB

- Outdoor temperature : 35°C DB, 24°C WB, Equivalent refrigerant piping : 7.5m, Level differences : 0m

2) Nominal heating capacities are based on;

- Indoor temperature : 20°C DB, 15°C WB

- Outdoor temperature : 7°C DB, 6°C WB, Equivalent refrigerant piping : 7.5m, Level differences : 0m

3) Sound pressure was acquired in an anechoic room. Thus actual noise level may be different depending on the installation conditions.

4) If outdoor unit is located in a higher position than indoor unit, level difference is 110m or under.

(If the level difference is higher than 50m, make a decision by PDM kit installation Guide software whether the PDM kit should be installed or not.)

*PDM kit: Pressure Drop Modulation kit

2 Specifications : Heat Pump (Standard)

Outdoor

Type			DVM S(NEW)	DVM S(NEW)	DVM S(NEW)	DVM S(NEW)	
Model Name			AM240HXVAGH/TK	AM260HXVAGH/TK	AM280HXVAGH1TK	AM300HXVAGH1TK	
Power Supply		Ø, #, V, Hz	3,4,380-415,50	3,4,380-415,50	3,4,380-415,50	3,4,380-415,50	
Mode			HP	HP	HP	HP	
Performance	Capacity (Nominal)	Cooling	HP	24.00	26.00	28.00	30.00
			kW	67.20	72.80	78.60	84.00
		Heating	Btu/h	229,300	248,400	268,200	286,600
			kW	75.60	81.90	88.20	94.50
			Btu/h	258,000	279,500	301,000	322,400
Power	Power Input (Nominal)	Cooling 1)	kW	17.10	19.30	19.40	21.28
		Heating 2)	kW	19.80	21.80	20.20	20.60
	Current Input (Nominal)	Cooling 1)	A	26.83	30.28	31.10	34.20
		Heating 2)	A	31.06	34.20	32.40	33.10
	MCA	A	55.00	58.00	57.00	64.10	
MFA	A	63.00	63.00	63.00	75.00		
COP	EER (Nominal Cooling)		-	3.93	3.77	4.05	3.95
	COP (Nominal Heating)		-	3.82	3.76	4.37	4.59
	Energy Grade		-	ESEER 6.48	ESEER 6.26	ESEER 6.91	ESEER 6.81
			-	-	-	-	
Compressor	Type		-	SSC Scroll x 2	SSC Scroll x 2	SSC Scroll x 3	SSC Scroll x 3
	Output		kW x n	(6.39 x 2)	(6.76 x 2)	(6.39) + (4.96x2)	(6.39) + (6.39x2)
	Model Name		-	DS-GB066FAVBSGx2	DS-GB070FAVASGx2	DS-GB066FAVBSGx1 + DS-GB052FAVBSGx2	DS-GB066FAVBSGx3
	Oil	Type	-	PVE	PVE	PVE	PVE
Fan	Type		-	Propeller	Propeller	Propeller	Propeller
	Output x n		W	620.0x2	620.0x2	830.0 + 620.0x2	830.0 + 620.0x2
	Air Flow Rate		CMM	310	310	220.0 + 255.0	220.0 + 290.0
			l/s	5,166.7	5,166.7	3,666.7 + 4,250.0	3,666.7 + 4,833.3
	External Static	Max.	mmAQ	8.00	8.00	8.00	8.00
Pa			78.45	78.45	78.45	78.45	
Piping Connections	Liquid Pipe		Ø, mm	15.88	19.05	19.05	19.05
			Ø, inch	5/8"	3/4"	3/4"	3/4"
	Gas Pipe		Ø, mm	34.92	34.92	34.92	34.92
			Ø, inch	1 3/8"	1 3/8"	1 3/8"	1 3/8"
	Discharge Gas Pipe		Ø, mm	-	-	-	-
			Ø, inch	-	-	-	-
Installation Limitation	Max. Length	m	200 (220)	200 (220)	200 (220)	200 (220)	
		Max. Height	m	110 (110)	110 (110)	110 (110)	110 (110)
Field Wiring	Power Source Wire		mm ²	-	-	-	-
	Transmission Cable		mm ²	0.75 ~ 1.50	0.75 ~ 1.50	0.75 ~ 1.50	0.75 ~ 1.50
Refrigerant	Type		-	R410A	R410A	R410A	R410A
	Factory Charging		kg	14.30	14.30	12.90	14.20
Sound	Pressure		dBA	67.00	67.00	66.00	66.00
	Power			91.00	91.00	85.00	87.00
External Dimension	New Weight		kg	360.0	360.0	184.5 + 278.0	184.5 + 300.0
	Shipping Weight		kg	375.0	375.0	200.5 + 297.0	200.5 + 319.0
	Net Dimensions (WxHxD)		mm	1,295x1,695x765	1,295x1,695x765	880x1,695x765 + 1,295x1,695x765	880x1,695x765 + 1,295x1,695x765
	Shipping Dimensions (WxHxD)		mm	1,363x1,887x832	1,363x1,887x832	948x1,887x832 + 1,363x1,887x832	948x1,887x832 + 1,363x1,887x832
Operating Temp.	Cooling		°C	-5.0 ~ 48.0	-5.0 ~ 48.0	-5.0 ~ 48.0	-5.0 ~ 48.0
	Heating		°C	-25.0 ~ 24.0	-25.0 ~ 24.0	-25.0 ~ 24.0	-25.0 ~ 24.0

* Specifications may be subject to change without prior notice for product improvement.

1) Nominal cooling capacities are based on;

- Indoor temperature : 27°C DB, 19°C WB

- Outdoor temperature : 35°C DB, 24°C WB, Equivalent refrigerant piping : 7.5m, Level differences : 0m

2) Nominal heating capacities are based on;

- Indoor temperature : 20°C DB, 15°C WB

- Outdoor temperature : 7°C DB, 6°C WB, Equivalent refrigerant piping : 7.5m, Level differences : 0m

3) Sound pressure was acquired in an anechoic room. Thus actual noise level may be different depending on the installation conditions.

4) If outdoor unit is located in a higher position than indoor unit, level difference is 110m or under.

(If the level difference is higher than 50m, make a decision by PDM kit installation Guide software whether the PDM kit should be installed or not.)

*PDM kit: Pressure Drop Modulation kit

2 Specifications : Heat Pump (Standard)

Outdoor

Type			DVM S(NEW)	DVM S(NEW)	DVM S(NEW)	DVM S(NEW)	
Model Name			AM320HXVAGH1TK	AM340HXVAGH1TK	AM360HXVAGH1TK	AM380HXVAGH1TK	
Power Supply		Ø, #, V, Hz	3,4,380-415,50	3,4,380-415,50	3,4,380-415,50	3,4,380-415,50	
Mode			HP	HP	HP	HP	
Performance	Capacity (Nominal)	Cooling	HP	32.00	34.00	36.00	38.00
			kW	89.60	95.20	101.60	106.60
		Heating	Btu/h	305,700	324,800	346,700	363,700
			kW	100.80	107.11	114.31	119.71
		Btu/h	343,900	365,500	390,000	408,500	
Power	Power Input (Nominal)	Cooling 1)	kW	23.59	25.75	26.25	28.35
		Heating 2)	kW	22.60	25.40	26.20	28.20
	Current Input (Nominal)	Cooling 1)	A	37.90	41.30	42.10	45.40
		Heating 2)	A	36.30	40.80	42.00	45.20
	MCA	A	67.50	69.50	69.50	76.50	
MFA	A	75.00	80.00	80.00	90.00		
COP	EER (Nominal Cooling)		-	3.80	3.70	3.87	3.76
	COP (Nominal Heating)		-	4.46	4.22	4.36	4.25
	Energy Grade		-	ESEER 6.80	ESEER 6.64	ESEER 6.64	ESEER 6.52
Compressor	Type		-	SSC Scroll x 3	SSC Scroll x 3	SSC Scroll x 3	SSC Scroll x 4
	Output		kW x n	(6.39) + (6.39x2)	(6.39) + (6.39x2)	(6.39) + (6.39x2)	(4.96x2) + (6.39x2)
	Model Name		-	DS-GB066FAVBSGx3	DS-GB066FAVBSGx3	DS-GB066FAVBSGx3	DS-GB052FAVBSGx2 + DS-GB066FAVBSGx2
	Oil	Type	-	PVE	PVE	PVE	PVE
Fan	Type		-	Propeller	Propeller	Propeller	Propeller
	Output x n		W	830.0 + 620.0x2	830.0 + 620.0x2	(620.0x2)x2	(620.0x2)x2
	Air Flow Rate		CMM	220.0 + 290.0	220.0 + 290.0	255.0 + 290.0	255.0 + 290.0
			l/s	3,666.7 + 4,833.3	3,666.7 + 4,833.3	4,250.0 + 4,833.3	4,250.0 + 4,833.3
	External Static	Max.	mmAQ	8.00	8.00	8.00	8.00
Pa			78.45	78.45	78.45	78.45	
Piping Connections	Liquid Pipe		Ø, mm	19.05	19.05	19.05	19.05
			Ø, inch	3/4"	3/4"	3/4"	3/4"
	Gas Pipe		Ø, mm	34.92	34.92	41.28	41.28
			Ø, inch	1 3/8"	1 3/8"	1 5/8"	1 5/8"
	Discharge Gas Pipe		Ø, mm	-	-	-	-
			Ø, inch	-	-	-	-
Installation Limitation	Max. Length	Max. Length	m	200 (220)	200 (220)	200 (220)	200 (220)
		Max. Height	m	110 (110)	110 (110)	110 (110)	110 (110)
Field Wiring	Power Source Wire		mm ²	-	-	-	-
	Transmission Cable		mm ²	0.75 ~ 1.50	0.75 ~ 1.50	0.75 ~ 1.50	0.75 ~ 1.50
Refrigerant	Type		-	R410A	R410A	R410A	R410A
	Factory Charging		kg	13.90	13.90	16.10	15.80
Sound	Pressure		dBA	67.00	67.00	67.00	68.00
	Power		dBA	88.00	90.00	90.00	90.00
External Dimension	New Weight		kg	184.5 + 300.0	184.5 + 300.0	235.0 + 300.0	278.0 + 300.0
	Shipping Weight		kg	200.5 + 319.0	200.5 + 319.0	254.0 + 319.0	297.0 + 319.0
	Net Dimensions (WxHxD)		mm	880x1,695x765 + 1,295x1,695x765	880x1,695x765 + 1,295x1,695x765	(1,295x1,695x765)x2	(1,295x1,695x765)x2
	Shipping Dimensions (WxHxD)		mm	948x1,887x832 + 1,363x1,887x832	948x1,887x832 + 1,363x1,887x832	(1,363x1,887x832)x2	(1,363x1,887x832)x2
Operating Temp.	Cooling		°C	-5.0 ~ 48.0	-5.0 ~ 48.0	-5.0 ~ 48.0	-5.0 ~ 48.0
	Heating		°C	-25.0 ~ 24.0	-25.0 ~ 24.0	-25.0 ~ 24.0	-25.0 ~ 24.0

* Specifications may be subject to change without prior notice for product improvement.

1) Nominal cooling capacities are based on;

- Indoor temperature : 27°C DB, 19°C WB

- Outdoor temperature : 35°C DB, 24°C WB, Equivalent refrigerant piping : 7.5m, Level differences : 0m

2) Nominal heating capacities are based on;

- Indoor temperature : 20°C DB, 15°C WB

- Outdoor temperature : 7°C DB, 6°C WB, Equivalent refrigerant piping : 7.5m, Level differences : 0m

3) Sound pressure was acquired in an anechoic room. Thus actual noise level may be different depending on the installation conditions.

4) If outdoor unit is located in a higher position than indoor unit, level difference is 110m or under.

(If the level difference is higher than 50m, make a decision by PDM kit installation Guide software whether the PDM kit should be installed or not.)

*PDM kit: Pressure Drop Modulation kit

2 Specifications : Heat Pump (Standard)

Outdoor

Type			DVM S(NEW)	DVM S(NEW)	DVM S(NEW)	DVM S(NEW)	
Model Name			AM400HXVAGH1TK	AM420HXVAGH1TK	AM440HXVAGH1TK	AM460HXVAGH1TK	
Power Supply			Ø, #, V, Hz	3,4,380-415,50	3,4,380-415,50	3,4,380-415,50	
Mode			-	HP	HP	HP	
Performance	Capacity (Nominal)	Cooling	HP	40.00	42.00	44.00	46.00
			kW	112.80	117.60	123.20	128.80
		Heating	Btu/h	384,900	401,300	420,400	439,500
			kW	126.90	132.31	138.62	144.91
			Btu/h	433,000	451,500	473,000	494,500
Power	Power Input (Nominal)	Cooling 1)	kW	28.20	32.54	34.70	34.15
		Heating 2)	kW	31.30	30.60	33.40	34.10
	Current Input (Nominal)	Cooling 1)	A	44.58	52.20	55.60	54.80
		Heating 2)	A	49.40	49.10	53.60	54.80
	MCA	A	83.00	87.00	89.00	94.50	
MFA	A	100.00	100.00	100.00	125.00		
COP	EER (Nominal Cooling)		-	4.00	3.61	3.55	3.77
	COP (Nominal Heating)		-	4.05	4.32	4.15	4.25
	Energy Grade	-	ESEER 6.64	ESEER 6.41	ESEER 6.25	ESEER 6.77	
		-	-	-	-	-	
Compressor	Type		-	SSC Scroll x 3	SSC Scroll x 4	SSC Scroll x 4	SSC Scroll x 4
	Output		kW x n	(6.39) + (6.76x2)	(6.39x2) + (6.39x2)	(6.39x2)x2	(6.39)x2 + (6.39x2)
	Model Name		-	DS-GB066FAVBSGx1 + DS-GB070FAVASGx2	DS-GB066FAVBSGx4	DS-GB066FAVBSGx4	DS-GB066FAVBSGx4
	Oil	Type	-	PVE	PVE	PVE	PVE
Fan	Type		-	Propeller	Propeller	Propeller	Propeller
	Output x n		W	(620.0x2)x2	(620.0x2)x2	(620.0x2)x2	(830.0)x2 + (620.0x2)x2
	Air Flow Rate		CMM	255.0 + 310.0	290.0x2	290.0x2	220.0x2 + 290.0
			l/s	4,250.0 + 5,166.7	4,833.3x2	4,833.3x2	3,666.7x2 + 4,833.3
	External Static	Max.	mmAQ	8.00	8.00	8.00	8.00
Pa			78.45	78.45	78.45	78.45	
Piping Connections	Liquid Pipe		Ø, mm	19.05	19.05	19.05	19.05
			Ø, inch	3/4"	3/4"	3/4"	3/4"
	Gas Pipe		Ø, mm	41.28	41.28	41.28	41.28
			Ø, inch	1 5/8"	1 5/8"	1 5/8"	1 5/8"
	Discharge Gas Pipe		Ø, mm	-	-	-	-
			Ø, inch	-	-	-	-
	Installation Limitation	Max. Length	m	200 (220)	200 (220)	200 (220)	200 (220)
Max. Height			m	110 (110)	110 (110)	110 (110)	110 (110)
Field Wiring	Power Source Wire		mm ²	-	-	-	-
	Transmission Cable		mm ²	0.75 ~ 1.50	0.75 ~ 1.50	0.75 ~ 1.50	0.75 ~ 1.50
Refrigerant	Type		-	R410A	R410A	R410A	R410A
	Factory Charging		kg	22.00	16.80	16.80	19.40
Sound	Pressure		dBA	68.00	69.00	69.00	69.00
	Power			91.00	91.00	92.00	90.00
External Dimension	New Weight		kg	235.0 + 360.0	300.0x2	300.0x2	190.0x2 + 300.0
	Shipping Weight		kg	254.0 + 375.0	319.0x2	319.0x2	206.0x2 + 319.0
	Net Dimensions (WxHxD)		mm	(1,295x1,695x765)x2	(1,295x1,695x765)x2	(1,295x1,695x765)x2	(880x1,695x765)x2 + 1,295x1,695x765
	Shipping Dimensions (WxHxD)		mm	(1,363x1,887x832)x2	(1,363x1,887x832)x2	(1,363x1,887x832)x2	(948x1,887x832)x2 + 1,363x1,887x832
Operating Temp.	Cooling		°C	-5.0 ~ 48.0	-5.0 ~ 48.0	-5.0 ~ 48.0	-5.0 ~ 48.0
	Heating		°C	-25.0 ~ 24.0	-25.0 ~ 24.0	-25.0 ~ 24.0	-25.0 ~ 24.0

* Specifications may be subject to change without prior notice for product improvement.

1) Nominal cooling capacities are based on;

- Indoor temperature : 27°C DB, 19°C WB

- Outdoor temperature : 35°C DB, 24°C WB, Equivalent refrigerant piping : 7.5m, Level differences : 0m

2) Nominal heating capacities are based on;

- Indoor temperature : 20°C DB, 15°C WB

- Outdoor temperature : 7°C DB, 6°C WB, Equivalent refrigerant piping : 7.5m, Level differences : 0m

3) Sound pressure was acquired in an anechoic room. Thus actual noise level may be different depending on the installation conditions.

4) If outdoor unit is located in a higher position than indoor unit, level difference is 110m or under.

(If the level difference is higher than 50m, make a decision by PDM kit installation Guide software whether the PDM kit should be installed or not.)

*PDM kit: Pressure Drop Modulation kit

2 Specifications : Heat Pump (Standard)

Outdoor

Type			DVM S(NEW)	DVM S(NEW)	DVM S(NEW)	DVM S(NEW)	
Model Name			AM480HXVAGH1TK	AM500HXVAGH1TK	AM520HXVAGH1TK	AM540HXVAGH1TK	
Power Supply			Ø, #, V, Hz	3,4,380-415,50	3,4,380-415,50	3,4,380-415,50	
Mode			-	HP	HP	HP	
Performance	Capacity (Nominal)	Cooling	HP	48.00	50.00	52.00	54.00
			kW	135.20	140.20	145.60	151.20
		Heating	Btu/h	461,300	478,400	496,800	515,900
			kW	152.11	157.51	163.81	170.11
Power	Power Input (Nominal)	Cooling 1)	kW	34.65	36.75	38.63	40.94
		Heating 2)	kW	34.90	36.90	37.30	39.30
	Current Input (Nominal)	Cooling 1)	A	55.60	58.90	62.00	65.70
		Heating 2)	A	56.00	59.20	59.90	63.10
	MCA	A	94.50	101.50	108.60	112.00	
	MFA	A	125.00	125.00	125.00	125.00	
COP	EER (Nominal Cooling)		-	3.90	3.81	3.77	3.69
	COP (Nominal Heating)		-	4.36	4.27	4.39	4.33
	Energy Grade		-	ESEER 6.77	ESEER 6.69	ESEER 6.62	ESEER 6.61
Compressor	Type		-	SSC Scroll x 4	SSC Scroll x 5	SSC Scroll x 5	SSC Scroll x 5
	Output		kW x n	(6.39) + (6.39) + (6.39x2)	(6.39) + (4.96x2) + (6.39x2)	(6.39) + (6.39x2) + (6.39x2)	(6.39) + (6.39x2) + (6.39x2)
	Model Name		-	DS-GB066FAVBSGx4	DS-GB066FAVBSGx3 + DS-GB052FAVBSGX2	DS-GB066FAVBSGx5	DS-GB066FAVBSGx5
	Oil	Type	-	PVE	PVE	PVE	PVE
Fan	Type		-	Propeller	Propeller	Propeller	Propeller
	Output x n		W	830.0 + (620.0x2)x2	830.0 + (620.0x2)x2	830.0 + (620.0x2)x2	830.0 + (620.0x2)x2
	Air Flow Rate		CMM	220.0 + 255.0 + 290.0	220.0 + 255.0 + 290.0	220.0 + 290.0x2	220.0 + 290.0x2
			l/s	3,666.7 + 4,250.0 + 4,833.3	3,666.7 + 4,250.0 + 4,833.3	3,666.7 + 4,833.3x2	3,666.7 + 4,833.3x2
	External Static	Max.	mmAQ	8.00	8.00	8.00	8.00
Pa			78.45	78.45	78.45	78.45	
Piping Connections	Liquid Pipe		Ø, mm	19.05	19.05	19.05	19.05
			Ø, inch	3/4"	3/4"	3/4"	3/4"
	Gas Pipe		Ø, mm	41.28	41.28	41.28	41.28
			Ø, inch	1 5/8"	1 5/8"	1 5/8"	1 5/8"
	Discharge Gas Pipe		Ø, mm	-	-	-	-
			Ø, inch	-	-	-	-
	Installation Limitation	Max. Length	m	200 (220)	200 (220)	200 (220)	200 (220)
Max. Height		m	110 (110)	110 (110)	110 (110)	110 (110)	
Field Wiring	Power Source Wire		mm ²	-	-	-	-
	Transmission Cable		mm ²	0.75 ~ 1.50	0.75 ~ 1.50	0.75 ~ 1.50	0.75 ~ 1.50
Refrigerant	Type		-	R410A	R410A	R410A	R410A
	Factory Charging		kg	21.60	21.30	22.60	22.30
Sound	Pressure		dBA	68.00	69.00	69.00	69.00
	Power			90.00	90.00	91.00	92.00
External Dimension	New Weight		kg	184.5 + 235.0 + 300.0	184.5 + 278.0 + 300.0	184.5 + 300.0x2	184.5 + 300.0x2
	Shipping Weight		kg	200.5 + 254.0 + 319.0	200.5 + 297.0 + 319.0	200.5 + 319.0x2	200.5 + 319.0x2
	Net Dimensions (WxHxD)		mm	880x1,695x765 + (1,295x1,695x765)x2	880x1,695x765 + (1,295x1,695x765)x2	880x1,695x765 + (1,295x1,695x765)x2	880x1,695x765 + (1,295x1,695x765)x2
	Shipping Dimensions (WxHxD)		mm	948x1,887x832 + (1,363x1,887x832)x2	948x1,887x832 + (1,363x1,887x832)x2	948x1,887x832 + (1,363x1,887x832)x2	948x1,887x832 + (1,363x1,887x832)x2
Operating Temp.	Cooling		°C	-5.0 ~ 48.0	-5.0 ~ 48.0	-5.0 ~ 48.0	-5.0 ~ 48.0
	Heating		°C	-25.0 ~ 24.0	-25.0 ~ 24.0	-25.0 ~ 24.0	-25.0 ~ 24.0

* Specifications may be subject to change without prior notice for product improvement.

1) Nominal cooling capacities are based on;

- Indoor temperature : 27°C DB, 19°C WB

- Outdoor temperature : 35°C DB, 24°C WB, Equivalent refrigerant piping : 7.5m, Level differences : 0m

2) Nominal heating capacities are based on;

- Indoor temperature : 20°C DB, 15°C WB

- Outdoor temperature : 7°C DB, 6°C WB, Equivalent refrigerant piping : 7.5m, Level differences : 0m

3) Sound pressure was acquired in an anechoic room. Thus actual noise level may be different depending on the installation conditions.

4) If outdoor unit is located in a higher position than indoor unit, level difference is 110m or under.

(If the level difference is higher than 50m, make a decision by PDM kit installation Guide software whether the PDM kit should be installed or not.)

*PDM kit: Pressure Drop Modulation kit

2 Specifications : Heat Pump (Standard)

Outdoor

Type			DVM S(NEW)	DVM S(NEW)	DVM S(NEW)	DVM S(NEW)	
Model Name			AM560HXVAGH1TK	AM580HXVAGH1TK	AM600HXVAGH1TK	AM620HXVAGH1TK	
Power Supply			Ø, #, V, Hz	3,4,380-415,50	3,4,380-415,50	3,4,380-415,50	
Mode			-	HP	HP	HP	
Performance	Capacity (Nominal)	Cooling	HP	56.00	58.00	60.00	62.00
			kW	156.80	163.20	168.20	173.60
		Heating	Btu/h	535,000	556,900	573,900	592,300
			kW	176.42	183.62	189.02	195.32
			Btu/h	602,000	626,500	645,000	666,500
Power	Power Input (Nominal)	Cooling 1)	kW	43.10	43.60	45.70	47.58
		Heating 2)	kW	42.10	42.90	44.90	45.30
	Current Input (Nominal)	Cooling 1)	A	69.10	69.90	73.20	76.30
		Heating 2)	A	67.60	68.80	72.00	72.70
	MCA	A	114.00	114.00	121.00	128.10	
MFA	A	125.00	125.00	150.00	150.00		
COP	EER (Nominal Cooling)		-	3.64	3.74	3.68	3.65
	COP (Nominal Heating)		-	4.19	4.28	4.21	4.31
	Energy Grade		-	ESEER 6.51	ESEER 6.51	ESEER 6.43	ESEER 6.36
			-	-	-	-	-
Compressor	Type		-	SSC Scroll x 5	SSC Scroll x 5	SSC Scroll x 6	SSC Scroll x 6
	Output		kW x n	(6.39) + (6.39x2)x2	(6.39) + (6.39x2)x2	(4.96x2) + (6.39x2)x2	(6.39x2) + (6.39x2)x2
	Model Name		-	DS-GB066FAVBSGx5	DS-GB066FAVBSGx5	DS-GB052FAVBSGx2 + DS-GB066FAVBSGx4	DS-GB066FAVBSGx6
	Oil	Type	-	PVE	PVE	PVE	PVE
Fan	Type		-	Propeller	Propeller	Propeller	Propeller
	Output x n		W	(830.0) + (620.0x2)x2	(620.0x2)x3	(620.0x2)x3	(620.0x2)x3
	Air Flow Rate		CMM	220.0 + 290.0x2	255.0 + 290.0x2	255.0 + 290.0x2	290.0x3
			l/s	3,666.7 + 4,833.3x2	4,250.0 + 4,833.3x2	4,250.0 + 4,833.3x2	4,833.3x3
	External Static	Max.	mmAQ	8.00	8.00	8.00	8.00
Pa			78.45	78.45	78.45	78.45	
Piping Connections	Liquid Pipe		Ø, mm	19.05	19.05	19.05	22.22
			Ø, inch	3/4"	3/4"	3/4"	7/8"
	Gas Pipe		Ø, mm	41.28	41.28	41.28	53.98
			Ø, inch	1 5/8"	1 5/8"	1 5/8"	2 1/8"
	Discharge Gas Pipe		Ø, mm	-	-	-	-
			Ø, inch	-	-	-	-
	Installation Limitation	Max. Length	m	200 (220)	200 (220)	200 (220)	200 (220)
Max. Height			m	110 (110)	110 (110)	110 (110)	110 (110)
Field Wiring	Power Source Wire		mm ²	-	-	-	-
	Transmission Cable		mm ²	0.75 ~ 1.50	0.75 ~ 1.50	0.75 ~ 1.50	0.75 ~ 1.50
Refrigerant	Type		-	R410A	R410A	R410A	R410A
	Factory Charging		kg	22.30	24.50	24.20	25.50
Sound	Pressure		dBA	70.00	70.00	70.00	70.00
	Power			92.00	92.00	93.00	93.00
External Dimension	New Weight		kg	184.5 + 300.0x2	235.0 + 300.0x2	278.0 + 300.0x2	300.0x3
	Shipping Weight		kg	200.5 + 319.0x2	254.0 + 319.0x2	297.0 + 319.0x2	319.0x3
	Net Dimensions (WxHxD)		mm	880x1,695x765 + (1,295x1,695x765)x2	(1,295x1,695x765)x3	(1,295x1,695x765)x3	(1,295x1,695x765)x3
	Shipping Dimensions (WxHxD)		mm	948x1,887x832 + (1,363x1,887x832)x2	(1,363x1,887x832)x3	(1,363x1,887x832)x3	(1,363x1,887x832)x3
Operating Temp.	Cooling		°C	-5.0 ~ 48.0	-5.0 ~ 48.0	-5.0 ~ 48.0	-5.0 ~ 48.0
	Heating		°C	-25.0 ~ 24.0	-25.0 ~ 24.0	-25.0 ~ 24.0	-25.0 ~ 24.0

* Specifications may be subject to change without prior notice for product improvement.

1) Nominal cooling capacities are based on;

- Indoor temperature : 27°C DB, 19°C WB

- Outdoor temperature : 35°C DB, 24°C WB, Equivalent refrigerant piping : 7.5m, Level differences : 0m

2) Nominal heating capacities are based on;

- Indoor temperature : 20°C DB, 15°C WB

- Outdoor temperature : 7°C DB, 6°C WB, Equivalent refrigerant piping : 7.5m, Level differences : 0m

3) Sound pressure was acquired in an anechoic room. Thus actual noise level may be different depending on the installation conditions.

4) If outdoor unit is located in a higher position than indoor unit, level difference is 110m or under.

(If the level difference is higher than 50m, make a decision by PDM kit installation Guide software whether the PDM kit should be installed or not.)

*PDM kit: Pressure Drop Modulation kit

2 Specifications : Heat Pump (Standard)

Outdoor

Type			DVM S(NEW)	DVM S(NEW)	DVM S(NEW)	DVM S(NEW)	
Model Name			AM640HXVAGH1TK	AM660HXVAGH1TK	AM680HXVAGH1TK	AM700HXVAGH1TK	
Power Supply			Ø, #, V, Hz	3,4,380-415,50	3,4,380-415,50	3,4,380-415,50	
Mode			-	HP	HP	HP	
Performance	Capacity (Nominal)	Cooling	HP	64.00	66.00	68.00	70.00
			kW	179.20	184.80	190.40	196.80
		Heating	Btu/h	611,500	630,600	649,700	671,500
			kW	201.62	207.93	214.22	221.42
			Btu/h	688,000	709,500	730,900	755,500
Power	Power Input (Nominal)	Cooling 1)	kW	49.89	52.05	51.50	52.00
		Heating 2)	kW	47.30	50.10	50.80	51.60
	Current Input (Nominal)	Cooling 1)	A	80.00	83.40	82.60	83.40
		Heating 2)	A	75.90	80.40	81.60	82.80
	MCA	A	131.50	133.50	139.00	139.00	
MFA	A	150.00	150.00	175.00	175.00		
COP	EER (Nominal Cooling)		-	3.59	3.55	3.70	3.78
	COP (Nominal Heating)		-	4.26	4.15	4.22	4.29
	Energy Grade		-	ESEER 6.35	ESEER 6.25	ESEER 6.64	ESEER 6.64
Compressor	Type		-	SSC Scroll x 6	SSC Scroll x 6	SSC Scroll x 6	SSC Scroll x 6
	Output		kW x n	(6.39x2) + (6.39x2)x2	(6.39x2)x3	(6.39)x2 + (6.39x2)x2	(6.39) + (6.39) + (6.39x2)x2
	Model Name		-	DS-GB066FAVBSGx6	DS-GB066FAVBSGx6	DS-GB066FAVBSGx6	DS-GB066FAVBSGx6
	Oil	Type	-	PVE	PVE	PVE	PVE
Fan	Type		-	Propeller	Propeller	Propeller	Propeller
	Output x n		W	(620.0x2)x3	(620.0x2)x3	(830.0)x2 + (620.0x2)x2	830.0 + (620.0x2)x3
	Air Flow Rate		CMM	290.0x3	290.0x3	220.0x2 + 290.0x2	220.0 + 255.0 + 290.0x2
			l/s	4,833.3x3	4,833.3x3	3,666.7x2 + 4,833.3x2	3,666.7 + 4,250.0 + 4,833.3x2
External Static	Max.	mmAQ	8.00	8.00	8.00	8.00	
		Pa	78.45	78.45	78.45	78.45	
Piping Connections	Liquid Pipe		Ø, mm	22.22	22.22	22.22	22.22
			Ø, inch	7/8"	7/8"	7/8"	7/8"
	Gas Pipe		Ø, mm	53.98	53.98	53.98	53.98
			Ø, inch	2 1/8"	2 1/8"	2 1/8"	2 1/8"
	Discharge Gas Pipe		Ø, mm	-	-	-	-
			Ø, inch	-	-	-	-
Installation Limitation	Max. Length	Max. Length	m	200 (220)	200 (220)	200 (220)	200 (220)
		Max. Height	m	110 (110)	110 (110)	110 (110)	110 (110)
Field Wiring	Power Source Wire		mm ²	-	-	-	-
	Transmission Cable		mm ²	0.75 ~ 1.50	0.75 ~ 1.50	0.75 ~ 1.50	0.75 ~ 1.50
Refrigerant	Type		-	R410A	R410A	R410A	R410A
	Factory Charging		kg	25.20	25.20	27.80	30.00
Sound	Pressure		dBA	70.00	71.00	70.00	70.00
	Power		dBA	93.00	94.00	93.00	93.00
External Dimension	New Weight		kg	300.0x3	300.0x3	184.5x2 + 300.0x2	184.5 + 235.0 + 300.0x2
	Shipping Weight		kg	319.0x3	319.0x3	200.5x2 + 319.0x2	200.5 + 254.0 + 319.0x2
	Net Dimensions (WxHxD)		mm	(1,295x1,695x765)x3	(1,295x1,695x765)x3	(880x1,695x765)x2 + (1,295x1,695x765)x2	880x1,695x765 + (1,295x1,695x765)x3
	Shipping Dimensions (WxHxD)		mm	(1,363x1,887x832)x3	(1,363x1,887x832)x3	(948x1,887x832)x2 + (1,363x1,887x832)x2	948x1,887x832 + (1,363x1,887x832)x3
Operating Temp.	Cooling		°C	-5.0 ~ 48.0	-5.0 ~ 48.0	-5.0 ~ 48.0	-5.0 ~ 48.0
	Heating		°C	-25.0 ~ 24.0	-25.0 ~ 24.0	-25.0 ~ 24.0	-25.0 ~ 24.0

* Specifications may be subject to change without prior notice for product improvement.

1) Nominal cooling capacities are based on;

- Indoor temperature : 27°C DB, 19°C WB

- Outdoor temperature : 35°C DB, 24°C WB, Equivalent refrigerant piping : 7.5m, Level differences : 0m

2) Nominal heating capacities are based on;

- Indoor temperature : 20°C DB, 15°C WB

- Outdoor temperature : 7°C DB, 6°C WB, Equivalent refrigerant piping : 7.5m, Level differences : 0m

3) Sound pressure was acquired in an anechoic room. Thus actual noise level may be different depending on the installation conditions.

4) If outdoor unit is located in a higher position than indoor unit, level difference is 110m or under.

(If the level difference is higher than 50m, make a decision by PDM kit installation Guide software whether the PDM kit should be installed or not.)

*PDM kit: Pressure Drop Modulation kit

2 Specifications : Heat Pump (Standard)

Outdoor

Type			DVM S(NEW)	DVM S(NEW)	DVM S(NEW)	DVM S(NEW)	
Model Name			AM720HXVAGH1TK	AM740HXVAGH1TK	AM760HXVAGH1TK	AM780HXVAGH1TK	
Power Supply		Ø, #, V, Hz	3,4,380-415,50	3,4,380-415,50	3,4,380-415,50	3,4,380-415,50	
Mode			HP	HP	HP	HP	
Performance	Capacity (Nominal)	Cooling	HP	72.00	74.00	76.00	78.00
			kW	201.80	207.20	212.80	218.40
		Heating	Btu/h	688,600	707,000	726,100	745,200
			kW	226.82	233.12	239.42	245.73
			Btu/h	773,900	795,400	816,900	838,500
Power	Power Input (Nominal)	Cooling 1)	kW	54.10	55.98	58.29	60.45
		Heating 2)	kW	53.60	54.00	56.00	58.80
	Current Input (Nominal)	Cooling 1)	A	86.70	89.80	93.50	96.90
		Heating 2)	A	86.00	86.70	89.90	94.40
	MCA	A	146.00	153.10	156.50	158.50	
MFA	A	175.00	175.00	175.00	175.00		
COP	EER (Nominal Cooling)		-	3.73	3.70	3.65	3.61
	COP (Nominal Heating)		-	4.23	4.32	4.28	4.18
	Energy Grade		-	ESEER 6.58	ESEER 6.53	ESEER 6.52	ESEER 6.45
Compressor	Type		-	SSC Scroll x 7	SSC Scroll x 7	SSC Scroll x 7	SSC Scroll x 7
	Output		kW x n	(6.39) + (4.96x2) + (6.39x2)x2	(6.39) + (6.39x2) + (6.39x2)x2	(6.39) + (6.39x2) + (6.39x2)x2	(6.39) + (6.39x2)x3
	Model Name		-	DS-GB066FAVBSGx5 + DS-GB052FAVBSGx2	DS-GB066FAVBSGx7	DS-GB066FAVBSGx7	DS-GB066FAVBSGx7
	Oil	Type	-	PVE	PVE	PVE	PVE
Fan	Type		-	Propeller	Propeller	Propeller	Propeller
	Output x n		W	830.0 + (620.0x2)x3	830.0 + (620.0x2)x3	830.0 + (620.0x2)x3	830.0 + (620.0x2)x3
	Air Flow Rate		CMM	220.0 + 255.0 + 290.0x2	220.0 + 290.0x3	220.0 + 290.0x3	220.0 + 290.0x3
			l/s	3,666.7 + 4,250.0 + 4,833.3x2	3,666.7 + 4,833.3x3	3,666.7 + 4,833.3x3	3,666.7 + 4,833.3x3
	External Static	Max.	mmAQ	8.00	8.00	8.00	8.00
Pa			78.45	78.45	78.45	78.45	
Piping Connections	Liquid Pipe		Ø, mm	22.22	22.22	22.22	22.22
			Ø, inch	7/8"	7/8"	7/8"	7/8"
	Gas Pipe		Ø, mm	53.98	53.98	53.98	53.98
			Ø, inch	2 1/8"	2 1/8"	2 1/8"	2 1/8"
	Discharge Gas Pipe		Ø, mm	-	-	-	-
			Ø, inch	-	-	-	-
	Installation Limitation	Max. Length	m	200 (220)	200 (220)	200 (220)	200 (220)
Max. Height		m	110 (110)	110 (110)	110 (110)	110 (110)	
Field Wiring	Power Source Wire		mm ²	-	-	-	-
	Transmission Cable		mm ²	0.75 ~ 1.50	0.75 ~ 1.50	0.75 ~ 1.50	0.75 ~ 1.50
Refrigerant	Type		-	R410A	R410A	R410A	R410A
	Factory Charging		kg	29.70	31.00	30.70	30.70
Sound	Pressure		dBA	71.00	71.00	71.00	71.00
	Power			93.00	93.00	93.00	94.00
External Dimension	New Weight		kg	184.5 + 278.0 + 300.0x2	184.5 + 300.0x3	184.5 + 300.0x3	184.5 + 300.0x3
	Shipping Weight		kg	200.5 + 297.0 + 319.0x2	200.5 + 319.0x3	200.5 + 319.0x3	200.5 + 319.0x3
	Net Dimensions (WxHxD)		mm	880x1,695x765 + (1,295x1,695x765)x3	880x1,695x765 + (1,295x1,695x765)x3	880x1,695x765 + (1,295x1,695x765)x3	880x1,695x765 + (1,295x1,695x765)x3
	Shipping Dimensions (WxHxD)		mm	948x1,887x832 + (1,363x1,887x832)x3	948x1,887x832 + (1,363x1,887x832)x3	948x1,887x832 + (1,363x1,887x832)x3	948x1,887x832 + (1,363x1,887x832)x3
Operating Temp.	Cooling		°C	-5.0 ~ 48.0	-5.0 ~ 48.0	-5.0 ~ 48.0	-5.0 ~ 48.0
	Heating		°C	-25.0 ~ 24.0	-25.0 ~ 24.0	-25.0 ~ 24.0	-25.0 ~ 24.0

* Specifications may be subject to change without prior notice for product improvement.

1) Nominal cooling capacities are based on;

- Indoor temperature : 27°C DB, 19°C WB

- Outdoor temperature : 35°C DB, 24°C WB, Equivalent refrigerant piping : 7.5m, Level differences : 0m

2) Nominal heating capacities are based on;

- Indoor temperature : 20°C DB, 15°C WB

- Outdoor temperature : 7°C DB, 6°C WB, Equivalent refrigerant piping : 7.5m, Level differences : 0m

3) Sound pressure was acquired in an anechoic room. Thus actual noise level may be different depending on the installation conditions.

4) If outdoor unit is located in a higher position than indoor unit, level difference is 110m or under.

(If the level difference is higher than 50m, make a decision by PDM kit installation Guide software whether the PDM kit should be installed or not.)

*PDM kit: Pressure Drop Modulation kit

2 Specifications : Heat Pump (Standard)

Outdoor

Type			DVM S(NEW)	
Model Name			AM800HXVAGH1TK	
Power Supply		Ø, #, V, Hz	3,4,380-415,50	
Mode			HP	
Performance	HP		80.00	
		Capacity (Nominal)	Cooling	kW
	Btu/h		767,000	
	Heating	kW	252.93	
		Btu/h	863,000	
Power	Power Input (Nominal)	Cooling 1)	kW	60.95
		Heating 2)	kW	59.60
	Current Input (Nominal)	Cooling 1)	A	97.70
		Heating 2)	A	95.60
	MCA	A	158.50	
	MFA	A	175.00	
COP	EER (Nominal Cooling)		-	3.69
	COP (Nominal Heating)		-	4.24
	Energy Grade		-	ESEER 6.44
			-	-
Compressor	Type		-	SSC Scroll x 7
	Output	kW x n		(6.39) + (6.39x2)x3
	Model Name		-	DS-GB066FAVBSGx7
	Oil	Type	-	PVE
Fan	Type		-	Propeller
	Output x n		W	(620.0x2)x4
	Air Flow Rate		CMM	255.0 + 290.0x3
			l/s	4,250.0 + 4,833.3x3
	External Static	Max.	mmAQ	8.00
Pa			78.45	
Piping Connections	Liquid Pipe		Ø, mm	22.22
			Ø, inch	7/8"
	Gas Pipe		Ø, mm	53.98
			Ø, inch	2 1/8"
	Discharge Gas Pipe		Ø, mm	-
			Ø, inch	-
	Installation Limitation	Max. Length	m	200 (220)
Max. Height		m	110 (110)	
Field Wiring	Power Source Wire		mm ²	-
	Transmission Cable		mm ²	0.75 ~ 1.50
Refrigerant	Type		-	R410A
	Factory Charging		kg	32.90
Sound	Pressure		dBA	71.00
	Power			94.00
External Dimension	New Weight		kg	235.0 + 300.0x3
	Shipping Weight		kg	254.0 + 319.0x3
	Net Dimensions (WxHxD)		mm	(1,295x1,695x765)x4
	Shipping Dimensions (WxHxD)		mm	(1,363x1,887x832)x4
Operating Temp.	Cooling		°C	-5.0 ~ 48.0
	Heating		°C	-25.0 ~ 24.0

* Specifications may be subject to change without prior notice for product improvement.

1) Nominal cooling capacities are based on;

- Indoor temperature : 27°C DB, 19°C WB

- Outdoor temperature : 35°C DB, 24°C WB, Equivalent refrigerant piping : 7.5m, Level differences : 0m

2) Nominal heating capacities are based on;

- Indoor temperature : 20°C DB, 15°C WB

- Outdoor temperature : 7°C DB, 6°C WB, Equivalent refrigerant piping : 7.5m, Level differences : 0m

3) Sound pressure was acquired in an anechoic room. Thus actual noise level may be different depending on the installation conditions.

4) If outdoor unit is located in a higher position than indoor unit, level difference is 110m or under.

(If the level difference is higher than 50m, make a decision by PDM kit installation Guide software whether the PDM kit should be installed or not.)

*PDM kit: Pressure Drop Modulation kit

2 Specifications : Heat Pump (Compact)

Outdoor

Type			DVM S(NEW)	DVM S(NEW)	DVM S(NEW)	DVM S(NEW)	
Model Name			AM360HXVAGH2TK	AM380HXVAGH2TK	AM460HXVAGH2TK	AM480HXVAGH2TK	
Power Supply			Ø, #, V, Hz	3,4,380-415,50	3,4,380-415,50	3,4,380-415,50	
Mode			-	HP	HP	HP	
Performance	Capacity (Nominal)	Cooling	HP	36.00	38.00	46.00	48.00
			kW	100.80	106.40	128.80	134.40
		Heating	Btu/h	343,900	363,100	439,500	458,600
			kW	113.40	119.70	144.90	151.21
Power	Power Input (Nominal)	Cooling 1)	kW	25.50	27.70	34.49	36.65
		Heating 2)	kW	28.50	30.50	35.70	38.50
	Current Input (Nominal)	Cooling 1)	A	40.33	43.78	54.68	58.08
		Heating 2)	A	45.06	48.20	56.50	61.00
	MCA	A	80.00	83.00	100.50	102.50	
	MFA	A	90.00	100.00	125.00	125.00	
COP	EER (Nominal Cooling)		-	3.95	3.84	3.73	3.67
	COP (Nominal Heating)		-	3.98	3.92	4.06	3.93
	Energy Grade		-	ESEER 6.76	ESEER 6.65	ESEER 6.41	ESEER 6.26
Compressor	Type		-	SSC Scroll x 3	SSC Scroll x 3	SSC Scroll x 4	SSC Scroll x 4
	Output		kW x n	(6.39) + (6.39x2)	(6.39) + (6.76x2)	(6.39x2) + (6.76x2)	(6.39x2) + (6.76x2)
	Model Name		-	DS-GB066FAVBSGx3	DS-GB066FAVBSGx1 + DS-GB070FAVASGx2	DS-GB066FAVBSGx2 + DS-GB070FAVASGx2	DS-GB066FAVBSGx2 + DS-GB070FAVASGx2
	Oil	Type	-	PVE	PVE	PVE	PVE
Fan	Type		-	Propeller	Propeller	Propeller	Propeller
	Output x n		W	830.0 + 620.0x2	830.0 + 620.0x2	(620.0x2)x2	(620.0x2)x2
	Air Flow Rate		CMM	220.0 + 310.0	220.0 + 310.0	290.0 + 310.0	290.0 + 310.0
			l/s	3,666.7 + 5,166.7	3,666.7 + 5,166.7	4,833.3 + 5,166.7	4,833.3 + 5,166.7
	External Static	Max.	mmAQ	8.00	8.00	8.00	8.00
Pa			78.45	78.45	78.45	78.45	
Piping Connections	Liquid Pipe		Ø, mm	19.05	19.05	19.05	19.05
			Ø, inch	3/4"	3/4"	3/4"	3/4"
	Gas Pipe		Ø, mm	41.28	41.28	41.28	41.28
			Ø, inch	1 5/8"	1 5/8"	1 5/8"	1 5/8"
	Discharge Gas Pipe		Ø, mm	-	-	-	-
			Ø, inch	-	-	-	-
Installation Limitation	Max. Length	Max. Length	m	200 (220)	200 (220)	200 (220)	200 (220)
		Max. Height	m	110 (110)	110 (110)	110 (110)	110 (110)
Field Wiring	Power Source Wire		mm ²	-	-	-	-
	Transmission Cable		mm ²	0.75 ~ 1.50	0.75 ~ 1.50	0.75 ~ 1.50	0.75 ~ 1.50
Refrigerant	Type		-	R410A	R410A	R410A	R410A
	Factory Charging		kg	19.80	19.80	22.70	22.70
Sound	Pressure		dBA	68.00	68.00	69.00	70.00
	Power			91.00	91.00	92.00	93.00
External Dimension	New Weight		kg	184.5 + 360.0	184.5 + 360.0	300.0 + 360.0	300.0 + 360.0
	Shipping Weight		kg	200.5 + 375.0	200.5 + 375.0	319.0 + 375.0	319.0 + 375.0
	Net Dimensions (WxHxD)		mm	880x1,695x765 + 1,295x1,695x765	880x1,695x765 + 1,295x1,695x765	(1,295x1,695x765)x2	(1,295x1,695x765)x2
	Shipping Dimensions (WxHxD)		mm	948x1,887x832 + 1,363x1,887x832	948x1,887x832 + 1,363x1,887x832	(1,363x1,887x832)x2	(1,363x1,887x832)x2
Operating Temp.	Cooling		°C	-5.0 ~ 48.0	-5.0 ~ 48.0	-5.0 ~ 48.0	-5.0 ~ 48.0
	Heating		°C	-25.0 ~ 24.0	-25.0 ~ 24.0	-25.0 ~ 24.0	-25.0 ~ 24.0

* Specifications may be subject to change without prior notice for product improvement.

1) Nominal cooling capacities are based on;

- Indoor temperature : 27°C DB, 19°C WB

- Outdoor temperature : 35°C DB, 24°C WB, Equivalent refrigerant piping : 7.5m, Level differences : 0m

2) Nominal heating capacities are based on;

- Indoor temperature : 20°C DB, 15°C WB

- Outdoor temperature : 7°C DB, 6°C WB, Equivalent refrigerant piping : 7.5m, Level differences : 0m

3) Sound pressure was acquired in an anechoic room. Thus actual noise level may be different depending on the installation conditions.

4) If outdoor unit is located in a higher position than indoor unit, level difference is 110m or under.

(If the level difference is higher than 50m, make a decision by PDM kit installation Guide software whether the PDM kit should be installed or not.)

*PDM kit: Pressure Drop Modulation kit

2 Specifications : Heat Pump (Compact)

Outdoor

Type			DVM S(NEW)	DVM S(NEW)	DVM S(NEW)	DVM S(NEW)	
Model Name			AM500HXVAGH2TK	AM520HXVAGH2TK	AM580HXVAGH2TK	AM600HXVAGH2TK	
Power Supply			Ø, #, V, Hz	3,4,380-415,50	3,4,380-415,50	3,4,380-415,50	
Mode			-	HP	HP	HP	
Performance	Capacity (Nominal)	Cooling	HP	50.00	52.00	58.00	60.00
			kW	140.00	145.60	162.40	168.00
		Heating	Btu/h	477,700	496,800	554,100	573,200
			kW	157.50	163.80	182.70	189.01
			Btu/h	537,400	558,900	623,400	644,900
Power	Power Input (Nominal)	Cooling 1)	kW	36.40	38.60	42.89	45.05
		Heating 2)	kW	41.60	43.60	44.40	47.20
	Current Input (Nominal)	Cooling 1)	A	57.11	60.56	68.18	71.58
		Heating 2)	A	65.26	68.40	70.50	75.00
	MCA	A	113.00	116.00	125.50	127.50	
MFA	A	125.00	150.00	150.00	150.00		
COP	EER (Nominal Cooling)		-	3.85	3.77	3.79	3.73
	COP (Nominal Heating)		-	3.79	3.76	4.11	4.00
	Energy Grade		-	ESEER 6.37	ESEER 6.26	ESEER 6.62	ESEER 6.52
			-	-	-	-	
Compressor	Type		-	SSC Scroll x 4	SSC Scroll x 4	SSC Scroll x 5	SSC Scroll x 5
	Output		kW x n	(6.39x2) + (6.76x2)	(6.76x2)x2	(6.39) + (6.39x2) + (6.76x2)	(6.39) + (6.39x2) + (6.76x2)
	Model Name		-	DS-GB066FAVBSGx2 + DS-GB070FAVASGx2	DS-GB070FAVASGx4	DS-GB066FAVBSGx3 + DS-GB070FAVASGx2	DS-GB066FAVBSGx3 + DS-GB070FAVASGx2
	Oil	Type	-	PVE	PVE	PVE	PVE
Fan	Type		-	Propeller	Propeller	Propeller	Propeller
	Output x n		W	(620.0x2)x2	(620.0x2)x2	830.0 + (620.0x2)x2	830.0 + (620.0x2)x2
	Air Flow Rate		CMM	310.0x2	310.0x2	220.0 + 290.0 + 310.0	220.0 + 290.0 + 310.0
			l/s	5,166.7x2	5,166.7x2	3,666.7 + 4,833.3 + 5,166.7	3,666.7 + 4,833.3 + 5,166.7
	External Static	Max.	mmAQ	8.00	8.00	8.00	8.00
Pa			78.45	78.45	78.45	78.45	
Piping Connections	Liquid Pipe		Ø, mm	19.05	19.05	19.05	19.05
			Ø, inch	3/4"	3/4"	3/4"	3/4"
	Gas Pipe		Ø, mm	41.28	41.28	41.28	41.28
			Ø, inch	1 5/8"	1 5/8"	1 5/8"	1 5/8"
	Discharge Gas Pipe		Ø, mm	-	-	-	-
			Ø, inch	-	-	-	-
	Installation Limitation	Max. Length	m	200 (220)	200 (220)	200 (220)	200 (220)
Max. Height			m	110 (110)	110 (110)	110 (110)	110 (110)
	Power Source Wire		mm ²	-	-	-	-
Transmission Cable		mm ²	0.75 ~ 1.50	0.75 ~ 1.50	0.75 ~ 1.50	0.75 ~ 1.50	
Refrigerant	Type		-	R410A	R410A	R410A	R410A
	Factory Charging		kg	28.60	28.60	28.20	28.20
Sound	Pressure		dBA	70.00	70.00	70.00	70.00
	Power			93.00	93.00	93.00	93.00
External Dimension	New Weight		kg	360.0x2	360.0x2	184.5 + 300.0 + 360.0	184.5 + 300.0 + 360.0
	Shipping Weight		kg	375.0x2	375.0x2	200.5 + 319.0 + 375.0	200.5 + 319.0 + 375.0
	Net Dimensions (WxHxD)		mm	(1,295x1,695x765)x2	(1,295x1,695x765)x2	880x1,695x765 + (1,295x1,695x765)x2	880x1,695x765 + (1,295x1,695x765)x2
	Shipping Dimensions (WxHxD)		mm	(1,363x1,887x832)x2	(1,363x1,887x832)x2	948x1,887x832 + (1,363x1,887x832)x2	948x1,887x832 + (1,363x1,887x832)x2
Operating Temp.	Cooling		°C	-5.0 ~ 48.0	-5.0 ~ 48.0	-5.0 ~ 48.0	-5.0 ~ 48.0
	Heating		°C	-25.0 ~ 24.0	-25.0 ~ 24.0	-25.0 ~ 24.0	-25.0 ~ 24.0

* Specifications may be subject to change without prior notice for product improvement.

1) Nominal cooling capacities are based on;

- Indoor temperature : 27°C DB, 19°C WB

- Outdoor temperature : 35°C DB, 24°C WB, Equivalent refrigerant piping : 7.5m, Level differences : 0m

2) Nominal heating capacities are based on;

- Indoor temperature : 20°C DB, 15°C WB

- Outdoor temperature : 7°C DB, 6°C WB, Equivalent refrigerant piping : 7.5m, Level differences : 0m

3) Sound pressure was acquired in an anechoic room. Thus actual noise level may be different depending on the installation conditions.

4) If outdoor unit is located in a higher position than indoor unit, level difference is 110m or under.

(If the level difference is higher than 50m, make a decision by PDM kit installation Guide software whether the PDM kit should be installed or not.)

*PDM kit: Pressure Drop Modulation kit

2 Specifications : Heat Pump (Compact)

Outdoor

Type			DVM S(NEW)	DVM S(NEW)	DVM S(NEW)	DVM S(NEW)	
Model Name			AM620HXVAGH2TK	AM640HXVAGH2EU	AM680HXVAGH2TK	AM700HXVAGH2TK	
Power Supply			Ø, #, V, Hz	3,4,380-415,50	3,4,380-415,50	3,4,380-415,50	
Mode			-	HP	HP	HP	
Performance	Capacity (Nominal)	Cooling	HP	62.00	64.00	68.00	70.00
			kW	173.60	179.20	190.40	196.00
		Heating	Btu/h	592,300	611,500	649,700	668,800
			kW	195.30	201.60	214.22	220.52
			Btu/h	666,400	687,900	730,900	752,400
Power	Power Input (Nominal)	Cooling 1)	kW	44.80	47.00	51.80	54.00
		Heating 2)	kW	50.30	52.30	53.20	55.20
	Current Input (Nominal)	Cooling 1)	A	70.61	74.06	82.43	85.88
		Heating 2)	A	79.26	82.40	84.66	87.80
	MCA	A	138.00	141.00	144.00	147.00	
MFA	A	175.00	175.00	175.00	175.00		
COP	EER (Nominal Cooling)		-	3.88	3.81	3.68	3.63
	COP (Nominal Heating)		-	3.88	3.85	4.03	3.99
	Energy Grade		-	ESEER 6.59	ESEER 6.52	ESEER 6.33	ESEER 6.25
			-	-	-	-	
Compressor	Type		-	SSC Scroll x 5	SSC Scroll x 5	SSC Scroll x 6	SSC Scroll x 6
	Output		kW x n	(6.39) + (6.39x2) + (6.76x2)	(6.39) + (6.76x2)x2	(6.39x2)x2 + (6.39x2)	(6.39x2)x2 + (6.76x2)
	Model Name		-	DS-GB066FAVBSGx3 + DS-GB070FAVASGx2	DS-GB066FAVBSGx1 + DS-GB070FAVASGx4	DS-GB066FAVBSGx6	DS-GB066FAVBSGx4 + DS-GB070FAVASGx2
	Oil	Type	-	PVE	PVE	PVE	PVE
Fan	Type		-	Propeller	Propeller	Propeller	Propeller
	Output x n		W	830.0 + (620.0x2)x2	830.0 + (620.0x2)x2	(620.0x2)x3	(620.0x2)x3
	Air Flow Rate		CMM	220.0 + 310.0x2	220.0 + 310.0x2	290.0x2 + 310.0	290.0x2 + 310.0
			l/s	3,666.7 + 5,166.7x2	3,666.7 + 5,166.7x2	4,833.3x2 + 5,166.7	4,833.3x2 + 5,166.7
	External Static	Max.	mmAQ	8.00	8.00	8.00	8.00
Pa			78.45	78.45	78.45	78.45	
Piping Connections	Liquid Pipe		Ø, mm	22.22	22.22	22.22	22.22
			Ø, inch	7/8"	7/8"	7/8"	7/8"
	Gas Pipe		Ø, mm	53.98	53.98	53.98	53.98
			Ø, inch	2 1/8"	2 1/8"	2 1/8"	2 1/8"
	Discharge Gas Pipe		Ø, mm	-	-	-	-
			Ø, inch	-	-	-	-
	Installation Limitation	Max. Length	m	200 (220)	200 (220)	200 (220)	200 (220)
Max. Height		m	110 (110)	110 (110)	110 (110)	110 (110)	
Field Wiring	Power Source Wire		mm ²	-	-	-	-
	Transmission Cable		mm ²	0.75 ~ 1.50	0.75 ~ 1.50	0.75 ~ 1.50	0.75 ~ 1.50
Refrigerant	Type		-	R410A	R410A	R410A	R410A
	Factory Charging		kg	34.10	34.10	31.10	31.10
Sound	Pressure		dBA	71.00	70.00	71.00	71.00
	Power			94.00	94.00	95.00	95.00
External Dimension	New Weight		kg	184.5 + 360.0x2	184.5 + 360.0x2	300.0x2 + 360.0	300.0x2 + 360.0
	Shipping Weight		kg	200.5 + 375.0x2	200.5 + 375.0x2	319.0x2 + 375.0	319.0x2 + 375.0
	Net Dimensions (WxHxD)		mm	880x1,695x765 + (1,295x1,695x765)x2	880x1,695x765 + (1,295x1,695x765)x2	(1,295x1,695x765)x3	(1,295x1,695x765)x3
	Shipping Dimensions (WxHxD)		mm	948x1,887x832 + (1,363x1,887x832)x2	948x1,887x832 + (1,363x1,887x832)x2	(1,363x1,887x832)x3	(1,363x1,887x832)x3
Operating Temp.	Cooling		°C	-5.0 ~ 48.0	-5.0 ~ 48.0	-5.0 ~ 48.0	-5.0 ~ 48.0
	Heating		°C	-25.0 ~ 24.0	-25.0 ~ 24.0	-25.0 ~ 24.0	-25.0 ~ 24.0

* Specifications may be subject to change without prior notice for product improvement.

1) Nominal cooling capacities are based on;

- Indoor temperature : 27°C DB, 19°C WB

- Outdoor temperature : 35°C DB, 24°C WB, Equivalent refrigerant piping : 7.5m, Level differences : 0m

2) Nominal heating capacities are based on;

- Indoor temperature : 20°C DB, 15°C WB

- Outdoor temperature : 7°C DB, 6°C WB, Equivalent refrigerant piping : 7.5m, Level differences : 0m

3) Sound pressure was acquired in an anechoic room. Thus actual noise level may be different depending on the installation conditions.

4) If outdoor unit is located in a higher position than indoor unit, level difference is 110m or under.

(If the level difference is higher than 50m, make a decision by PDM kit installation Guide software whether the PDM kit should be installed or not.)

*PDM kit: Pressure Drop Modulation kit

2 Specifications : Heat Pump (Compact)

Outdoor

Type			DVM S(NEW)	DVM S(NEW)	DVM S(NEW)	DVM S(NEW)		
Model Name			AM720HXVAGH2TK	AM740HXVAGH2TK	AM760HXVAGH2TK	AM780HXVAGH2TK		
Power Supply			Ø, #, V, Hz	3,4,380-415,50	3,4,380-415,50	3,4,380-415,50		
Mode			-	HP	HP	HP		
Performance	HP	Capacity (Nominal)	HP	72.00	74.00	76.00	78.00	
			Cooling	kW	201.60	207.20	212.80	218.40
				Btu/h	687,900	707,000	726,100	745,200
			Heating	kW	226.81	233.11	239.40	245.70
Btu/h	773,900	795,400		816,900	838,400			
Power	Power Input (Nominal)	Cooling 1)	kW	53.75	55.95	55.70	57.90	
		Heating 2)	kW	58.30	60.30	63.40	65.40	
	Current Input (Nominal)	Cooling 1)	A	84.91	88.36	87.39	90.84	
		Heating 2)	A	92.06	95.20	99.46	102.60	
	MCA	A	157.50	160.50	171.00	174.00		
MFA	A	175.00	200.00	200.00	200.00			
COP	EER (Nominal Cooling)		-	3.75	3.70	3.82	3.77	
	COP (Nominal Heating)		-	3.89	3.87	3.78	3.76	
	Energy Grade		-	ESEER 6.33	ESEER 6.26	ESEER 6.33	ESEER 6.26	
Compressor	Type		-	SSC Scroll x 6	SSC Scroll x 6	SSC Scroll x 6	SSC Scroll x 6	
	Output		kW x n	(6.39x2) + (6.39x2) + (6.76x2)	(6.39x2) + (6.76x2)x2	(6.39x2) + (6.76x2)x2	(6.76x2)x3	
	Model Name		-	DS-GB066FAVBSGx4 + DS-GB070FAVASGx2	DS-GB066FAVBSGx2 + DS-GB070FAVASGx4	DS-GB066FAVBSGx2 + DS-GB070FAVASGx4	DS-GB070FAVASGx6	
	Oil	Type	-	PVE	PVE	PVE	PVE	
Fan	Type		-	Propeller	Propeller	Propeller	Propeller	
	Output x n		W	(620.0x2)x3	(620.0x2)x3	(620.0x2)x3	(620.0x2)x3	
	Air Flow Rate		CMM	290.0 + 310.0x2	290.0 + 310.0x2	310.0x3	310.0x3	
			l/s	4,833.3 + 5,166.7x2	4,833.3 + 5,166.7x2	5,166.7x3	5,166.7x3	
External Static	Max.	mmAQ	8.00	8.00	8.00	8.00		
		Pa	78.45	78.45	78.45	78.45		
Piping Connections	Liquid Pipe		Ø, mm	22.22	22.22	22.22	22.22	
			Ø, inch	7/8"	7/8"	7/8"	7/8"	
	Gas Pipe		Ø, mm	53.98	53.98	53.98	53.98	
			Ø, inch	2 1/8"	2 1/8"	2 1/8"	2 1/8"	
	Discharge Gas Pipe		Ø, mm	-	-	-	-	
			Ø, inch	-	-	-	-	
Installation Limitation	Max. Length	Max. Length	m	200 (220)	200 (220)	200 (220)	200 (220)	
		Max. Height	m	110 (110)	110 (110)	110 (110)	110 (110)	
Field Wiring	Power Source Wire		mm ²	-	-	-	-	
	Transmission Cable		mm ²	0.75 ~ 1.50	0.75 ~ 1.50	0.75 ~ 1.50	0.75 ~ 1.50	
Refrigerant	Type		-	R410A	R410A	R410A	R410A	
	Factory Charging		kg	37.00	37.00	42.90	42.90	
Sound	Pressure		dBA	71.00	71.00	72.00	72.00	
	Power		dBA	95.00	95.00	96.00	96.00	
External Dimension	New Weight		kg	300.0 + 360.0x2	300.0 + 360.0x2	360.0x3	360.0x3	
	Shipping Weight		kg	319.0 + 375.0x2	319.0 + 375.0x2	375.0x3	375.0x3	
	Net Dimensions (WxHxD)		mm	(1,295x1,695x765)x3	(1,295x1,695x765)x3	(1,295x1,695x765)x3	(1,295x1,695x765)x3	
	Shipping Dimensions (WxHxD)		mm	(1,363x1,887x832)x3	(1,363x1,887x832)x3	(1,363x1,887x832)x3	(1,363x1,887x832)x3	
Operating Temp.	Cooling		°C	-5.0 ~ 48.0	-5.0 ~ 48.0	-5.0 ~ 48.0	-5.0 ~ 48.0	
	Heating		°C	-25.0 ~ 24.0	-25.0 ~ 24.0	-25.0 ~ 24.0	-25.0 ~ 24.0	

* Specifications may be subject to change without prior notice for product improvement.

1) Nominal cooling capacities are based on;

- Indoor temperature : 27°C DB, 19°C WB

- Outdoor temperature : 35°C DB, 24°C WB, Equivalent refrigerant piping : 7.5m, Level differences : 0m

2) Nominal heating capacities are based on;

- Indoor temperature : 20°C DB, 15°C WB

- Outdoor temperature : 7°C DB, 6°C WB, Equivalent refrigerant piping : 7.5m, Level differences : 0m

3) Sound pressure was acquired in an anechoic room. Thus actual noise level may be different depending on the installation conditions.

4) If outdoor unit is located in a higher position than indoor unit, level difference is 110m or under.

(If the level difference is higher than 50m, make a decision by PDM kit installation Guide software whether the PDM kit should be installed or not.)

*PDM kit: Pressure Drop Modulation kit

2 Specifications : Heat Recovery

Outdoor

Type			DVM S(NEW)	DVM S(NEW)	DVM S(NEW)	DVM S(NEW)	
Model Name			AM080FXVAGR/TK	AM100FXVAGR/TK	AM120FXVAGR/TK	AM140FXVAGR/TK	
Power Supply		Ø, #, V, Hz	3,4,380-415,50	3,4,380-415,50	3,4,380-415,50	3,4,380-415,50	
Mode			-	HR	HR	HR	
Performance	HP		HP	8.00	10.00	12.00	14.00
		Capacity (Nominal)	Cooling	kW	22.40	28.00	33.60
	Btu/h			76,400	95,500	114,600	136,500
		Heating	kW	25.20	31.50	37.80	45.00
Btu/h			86,000	107,500	129,000	153,500	
Power	Power Input (Nominal)	Cooling 1)	kW	5.00	6.80	8.40	8.90
		Heating 2)	kW	5.10	6.70	8.70	9.50
	Current Input (Nominal)	Cooling 1)	A	8.00	10.90	13.50	14.30
		Heating 2)	A	8.20	10.70	14.00	15.20
	MCA	A	18.00	21.10	25.00	25.00	
MFA	A	25.00	32.00	32.00	32.00		
COP	EER (Nominal Cooling)		-	4.48	4.12	4.00	4.49
	COP (Nominal Heating)		-	4.94	4.70	4.34	4.74
	Energy Grade		-	-	-	-	-
Compressor	Type		-	SSC Scroll x 1	SSC Scroll x 1	SSC Scroll x 1	SSC Scroll x 1
	Output		kW x n	(4.96)	(6.13)	(6.13)	(6.13)
	Model Name		-	DS-GB052FAVBSGx1	DS-GB066FAVASGx1	DS-GB066FAVASGx1	DS-GB066FAVASGx1
	Oil	Type	-	PVE	PVE	PVE	PVE
Fan	Type		-	Propeller	Propeller	Propeller	Propeller
	Output x n		W	830.0	830.0	830.0	620.0x2
	Air Flow Rate		CMM	170	170	220	255
			l/s	2,833.3	2,833.3	3,666.7	4,250.0
	External Static	Max.	mmAQ	8.00	8.00	8.00	8.00
Pa			78.45	78.45	78.45	78.45	
Piping Connections	Liquid Pipe		Ø, mm	9.52	9.52	12.70	12.70
			Ø, inch	3/8"	3/8"	1/2"	1/2"
	Gas Pipe		Ø, mm	19.05	22.22	28.58	28.58
			Ø, inch	3/4"	7/8"	1 1/8"	1 1/8"
	Discharge Gas Pipe		Ø, mm	15.88	19.05	19.05	22.22
			Ø, inch	5/8"	3/4"	3/4"	7/8"
Installation Limitation	Max. Length	m	200 (220)	200 (220)	200 (220)	200 (220)	
	Max. Height	m	110 (110)	110 (110)	110 (110)	110 (110)	
Field Wiring	Power Source Wire		mm ²	-	-	-	-
	Transmission Cable		mm ²	0.75 ~ 1.50	0.75 ~ 1.50	0.75 ~ 1.50	0.75 ~ 1.50
Refrigerant	Type		-	R410A	R410A	R410A	R410A
	Factory Charging		kg	5.50	5.20	5.50	7.70
Sound	Pressure		dBA	57.00	58.00	62.00	61.00
	Power			77.00	79.00	81.00	81.00
External Dimension	New Weight		kg	189.5	189.5	189.5	241.0
	Shipping Weight		kg	205.5	205.5	205.5	260.0
	Net Dimensions (WxHxD)		mm	880x1,695x765	880x1,695x765	880x1,695x765	1,295x1,695x765
	Shipping Dimensions (WxHxD)		mm	948x1,887x832	948x1,887x832	948x1,887x832	1,363x1,887x832
Operating Temp.	Cooling		°C	-15.0 ~ 48.0	-15.0 ~ 48.0	-15.0 ~ 48.0	-15.0 ~ 48.0
	Heating		°C	-25.0 ~ 24.0	-25.0 ~ 24.0	-25.0 ~ 24.0	-25.0 ~ 24.0

* Specifications may be subject to change without prior notice for product improvement.

1) Nominal cooling capacities are based on;

- Indoor temperature : 27°C DB, 19°C WB

- Outdoor temperature : 35°C DB, 24°C WB, Equivalent refrigerant piping : 7.5m, Level differences : 0m

2) Nominal heating capacities are based on;

- Indoor temperature : 20°C DB, 15°C WB

- Outdoor temperature : 7°C DB, 6°C WB, Equivalent refrigerant piping : 7.5m, Level differences : 0m

3) Sound pressure was acquired in an anechoic room. Thus actual noise level may be different depending on the installation conditions.

4) If outdoor unit is located in a higher position than indoor unit, level difference is 110m or under.

(If the level difference is higher than 50m, make a decision by PDM kit installation Guide software whether the PDM kit should be installed or not.)

*PDM kit: Pressure Drop Modulation kit

2 Specifications : Heat Recovery

Outdoor

Type			DVM S(NEW)	DVM S(NEW)	DVM S(NEW)	DVM S(NEW)	
Model Name			AM160FXVAGR/TK	AM180FXVAGR/TK	AM200FXVAGR/TK	AM220FXVAGR/TK	
Power Supply		Ø, #, V, Hz	3,4,380-415,50	3,4,380-415,50	3,4,380-415,50	3,4,380-415,50	
Mode			-	HR	HR	HR	
Performance	HP		HP	16.00	18.00	20.00	22.00
		Capacity (Nominal)	Cooling	kW	45.00	50.40	56.00
	Btu/h			153,500	172,000	191,100	210,200
		Heating	kW	50.40	56.70	63.00	69.30
Btu/h			172,000	193,500	215,000	236,500	
Power	Power Input (Nominal)	Cooling 1)	kW	11.00	12.88	15.19	17.35
		Heating 2)	kW	11.50	11.90	13.90	16.70
	Current Input (Nominal)	Cooling 1)	A	17.60	20.70	24.40	27.80
		Heating 2)	A	18.40	19.10	22.30	26.80
	MCA	A	32.00	39.10	42.50	44.50	
MFA	A	40.00	50.00	63.00	63.00		
COP	EER (Nominal Cooling)		-	4.09	3.91	3.69	3.55
	COP (Nominal Heating)		-	4.38	4.76	4.53	4.15
	Energy Grade		-	-	-	-	-
Compressor	Type		-	SSC Scroll x 2	SSC Scroll x 2	SSC Scroll x 2	SSC Scroll x 2
	Output		kW x n	(4.96 x 2)	(6.13 x 2)	(6.13 x 2)	(6.13 x 2)
	Model Name		-	DS-GB052FAVBSGx2	DS-GB066FAVASGx2	DS-GB066FAVASGx2	DS-GB066FAVASGx2
	Oil	Type	-	PVE	PVE	PVE	PVE
Fan	Type		-	Propeller	Propeller	Propeller	Propeller
	Output x n		W	620.0x2	620.0x2	620.0x2	620.0x2
	Air Flow Rate		CMM	255	290	290	290
			l/s	4,250.0	4,833.3	4,833.3	4,833.3
	External Static	Max.	mmAQ	8.00	8.00	8.00	8.00
Pa			78.45	78.45	78.45	78.45	
Piping Connections	Liquid Pipe		Ø, mm	12.70	15.88	15.88	15.88
			Ø, inch	1/2"	5/8"	5/8"	5/8"
	Gas Pipe		Ø, mm	28.58	28.58	28.58	28.58
			Ø, inch	1 1/8"	1 1/8"	1 1/8"	1 1/8"
	Discharge Gas Pipe		Ø, mm	22.22	22.22	28.58	28.58
			Ø, inch	7/8"	7/8"	1 1/8"	1 1/8"
	Installation Limitation	Max. Length	m	200 (220)	200 (220)	200 (220)	200 (220)
Max. Height		m	110 (110)	110 (110)	110 (110)	110 (110)	
Field Wiring	Power Source Wire		mm ²	-	-	-	-
	Transmission Cable		mm ²	0.75 ~ 1.50	0.75 ~ 1.50	0.75 ~ 1.50	0.75 ~ 1.50
Refrigerant	Type		-	R410A	R410A	R410A	R410A
	Factory Charging		kg	7.40	8.70	8.40	8.40
Sound	Pressure		dBA	63.00	64.00	65.00	65.00
	Power			83.00	86.00	87.00	89.00
External Dimension	New Weight		kg	284.0	306.0	306.0	306.0
	Shipping Weight		kg	303.0	325.0	325.0	325.0
	Net Dimensions (WxHxD)		mm	1,295x1,695x765	1,295x1,695x765	1,295x1,695x765	1,295x1,695x765
	Shipping Dimensions (WxHxD)		mm	1,363x1,887x832	1,363x1,887x832	1,363x1,887x832	1,363x1,887x832
Operating Temp.	Cooling		°C	-15.0 ~ 48.0	-15.0 ~ 48.0	-15.0 ~ 48.0	-15.0 ~ 48.0
	Heating		°C	-25.0 ~ 24.0	-25.0 ~ 24.0	-25.0 ~ 24.0	-25.0 ~ 24.0

* Specifications may be subject to change without prior notice for product improvement.

1) Nominal cooling capacities are based on;

- Indoor temperature : 27°C DB, 19°C WB

- Outdoor temperature : 35°C DB, 24°C WB, Equivalent refrigerant piping : 7.5m, Level differences : 0m

2) Nominal heating capacities are based on;

- Indoor temperature : 20°C DB, 15°C WB

- Outdoor temperature : 7°C DB, 6°C WB, Equivalent refrigerant piping : 7.5m, Level differences : 0m

3) Sound pressure was acquired in an anechoic room. Thus actual noise level may be different depending on the installation conditions.

4) If outdoor unit is located in a higher position than indoor unit, level difference is 110m or under.

(If the level difference is higher than 50m, make a decision by PDM kit installation Guide software whether the PDM kit should be installed or not.)

*PDM kit: Pressure Drop Modulation kit

2 Specifications : Heat Recovery

Outdoor

Type			DVM S(NEW)	DVM S(NEW)	DVM S(NEW)	DVM S(NEW)	
Model Name			AM240FXVAGR/TK	AM260FXVAGR/TK	AM280FXVAGR/TK	AM300FXVAGR/TK	
Power Supply		Ø, #, V, Hz	3,4,380-415,50	3,4,380-415,50	3,4,380-415,50	3,4,380-415,50	
Mode			-	HR	HR	HR	
Performance	HP		24.00	26.00	28.00	30.00	
			kW	67.20	73.60	78.60	84.00
	Capacity (Nominal)	Cooling	Btu/h	229,300	251,100	268,200	286,600
		Heating	kW	75.60	82.80	88.20	94.50
		Btu/h	258,000	282,500	301,000	322,400	
Power	Power Input (Nominal)	Cooling 1)	kW	16.80	17.30	19.40	21.28
		Heating 2)	kW	17.40	18.20	20.20	20.60
	Current Input (Nominal)	Cooling 1)	A	27.00	27.80	31.10	34.20
		Heating 2)	A	28.00	29.20	32.40	33.10
	MCA	A	50.00	50.00	57.00	64.10	
MFA	A	63.00	63.00	63.00	75.00		
COP	EER (Nominal Cooling)		-	4.00	4.25	4.05	3.95
	COP (Nominal Heating)		-	4.34	4.55	4.37	4.59
	Energy Grade		-	-	-	-	-
Compressor	Type		-	SSC Scroll x 2	SSC Scroll x 2	SSC Scroll x 3	SSC Scroll x 3
	Output		kW x n	(6.13)x2	(6.13) + (6.13)	(6.13) + (4.96x2)	(6.13) + (6.13x2)
	Model Name		-	DS-GB066FAVASGx2	DS-GB066FAVASGx2	DS-GB052FAVBSGx2+ DS-GB066FAVASGx1	DS-GB066FAVASGx3
	Oil	Type	-	PVE	PVE	PVE	PVE
Fan	Type		-	Propeller	Propeller	Propeller	Propeller
	Output x n		W	(830.0)x2	830.0 + 620.0x2	830.0 + 620.0x2	830.0 + 620.0x2
	Air Flow Rate		CMM	220.0x2	220.0 + 255.0	220.0 + 255.0	220.0 + 290.0
			l/s	3,666.7x2	3,666.7 + 4,250.0	3,666.7 + 4,250.0	3,666.7 + 4,833.3
	External Static	Max.	mmAQ	8.00	8.00	8.00	8.00
Pa			78.45	78.45	78.45	78.45	
Piping Connections	Liquid Pipe		Ø, mm	15.88	19.05	19.05	19.05
			Ø, inch	5/8"	3/4"	3/4"	3/4"
	Gas Pipe		Ø, mm	34.92	34.92	34.92	34.92
			Ø, inch	1 3/8"	1 3/8"	1 3/8"	1 3/8"
	Discharge Gas Pipe		Ø, mm	28.58	28.58	28.58	28.58
			Ø, inch	1 1/8"	1 1/8"	1 1/8"	1 1/8"
Installation Limitation	Max. Length	m	200 (220)	200 (220)	200 (220)	200 (220)	
	Max. Height	m	110 (110)	110 (110)	110 (110)	110 (110)	
Field Wiring	Power Source Wire		mm ²	-	-	-	-
	Transmission Cable		mm ²	0.75 ~ 1.50	0.75 ~ 1.50	0.75 ~ 1.50	0.75 ~ 1.50
Refrigerant	Type		-	R410A	R410A	R410A	R410A
	Factory Charging		kg	11.00	13.20	12.90	14.20
Sound	Pressure		dBA	66.00	66.00	-	-
	Power			91.00	91.00	-	-
External Dimension	New Weight		kg	189.5x2	189.5 + 241.0	189.5 + 284.0	189.5 + 306.0
	Shipping Weight		kg	205.5x2	205.5 + 260.0	205.5 + 303.0	205.5 + 325.0
	Net Dimensions (WxHxD)		mm	(880x1,695x765)x2	880x1,695x765 + 1,295x1,695x765	880x1,695x765 + 1,295x1,695x765	880x1,695x765 + 1,295x1,695x765
	Shipping Dimensions (WxHxD)		mm	(948x1,887x832)x2	948x1,887x832 + 1,363x1,887x832	948x1,887x832 + 1,363x1,887x832	948x1,887x832 + 1,363x1,887x832
Operating Temp.	Cooling		°C	-15.0 ~ 48.0	-15.0 ~ 48.0	-15.0 ~ 48.0	-15.0 ~ 48.0
	Heating		°C	-20.0 ~ 24.0	-20.0 ~ 24.0	-20.0 ~ 24.0	-20.0 ~ 24.0

* Specifications may be subject to change without prior notice for product improvement.

1) Nominal cooling capacities are based on;

- Indoor temperature : 27°C DB, 19°C WB

- Outdoor temperature : 35°C DB, 24°C WB, Equivalent refrigerant piping : 7.5m, Level differences : 0m

2) Nominal heating capacities are based on;

- Indoor temperature : 20°C DB, 15°C WB

- Outdoor temperature : 7°C DB, 6°C WB, Equivalent refrigerant piping : 7.5m, Level differences : 0m

3) Sound pressure was acquired in an anechoic room. Thus actual noise level may be different depending on the installation conditions.

4) If outdoor unit is located in a higher position than indoor unit, level difference is 110m or under.

(If the level difference is higher than 50m, make a decision by PDM kit installation Guide software whether the PDM kit should be installed or not.)

*PDM kit: Pressure Drop Modulation kit

2 Specifications : Heat Recovery

Outdoor

Type			DVM S(NEW)	DVM S(NEW)	DVM S(NEW)	DVM S(NEW)	
Model Name			AM320FXVAGR/TK	AM340FXVAGR/TK	AM360FXVAGR/TK	AM380FXVAGR/TK	
Power Supply		Ø, #, V, Hz	3,4,380-415,50	3,4,380-415,50	3,4,380-415,50	3,4,380-415,50	
Mode			-	HR	HR	HR	
Performance	HP		32.00	34.00	36.00	38.00	
			kW	89.60	95.20	101.60	106.60
	Capacity (Nominal)	Cooling	Btu/h	305,700	324,800	346,700	363,700
		Heating	kW	100.80	107.10	114.30	119.70
		Btu/h	343,900	365,400	390,000	408,400	
Power	Power Input (Nominal)	Cooling 1)	kW	23.59	25.75	26.25	28.35
		Heating 2)	kW	22.60	25.40	26.20	28.20
	Current Input (Nominal)	Cooling 1)	A	37.90	41.30	42.10	45.40
		Heating 2)	A	36.30	40.80	42.00	45.20
	MCA	A	67.50	69.50	69.50	76.50	
MFA	A	75.00	80.00	80.00	90.00		
COP	EER (Nominal Cooling)		-	3.80	3.70	3.87	3.76
	COP (Nominal Heating)		-	4.46	4.22	4.36	4.24
	Energy Grade		-	-	-	-	-
Compressor	Type		-	SSC Scroll x 3	SSC Scroll x 3	SSC Scroll x 3	SSC Scroll x 4
	Output		kW x n	(6.13) + (6.13x2)	(6.13) + (6.13x2)	(6.13) + (6.13x2)	(4.96x2) + (6.13x2)
	Model Name		-	DS-GB066FAVASGx3	DS-GB066FAVASGx3	DS-GB066FAVASGx3	DS-GB052FAVBGSx2+ DS-GB066FAVASGx2
	Oil	Type	-	PVE	PVE	PVE	PVE
Fan	Type		-	Propeller	Propeller	Propeller	Propeller
	Output x n		W	830.0 + 620.0x2	830.0 + 620.0x2	(620.0x2)x2	(620.0x2)x2
	Air Flow Rate		CMM	220.0 + 290.0	220.0 + 290.0	255.0 + 290.0	255.0 + 290.0
			l/s	3,666.7 + 4,833.3	3,666.7 + 4,833.3	4,250.0 + 4,833.3	4,250.0 + 4,833.3
	External Static	Max.	mmAQ	8.00	8.00	8.00	8.00
Pa			78.45	78.45	78.45	78.45	
Piping Connections	Liquid Pipe		Ø, mm	19.05	19.05	19.05	19.05
			Ø, inch	3/4"	3/4"	3/4"	3/4"
	Gas Pipe		Ø, mm	34.92	34.92	41.28	41.28
			Ø, inch	1 3/8"	1 3/8"	1 5/8"	1 5/8"
	Discharge Gas Pipe		Ø, mm	28.58	28.58	34.92	34.92
			Ø, inch	1 1/8"	1 1/8"	1 3/8"	1 3/8"
	Installation Limitation	Max. Length	m	200 (220)	200 (220)	200 (220)	200 (220)
Max. Height		m	110 (110)	110 (110)	110 (110)	110 (110)	
Field Wiring	Power Source Wire		mm ²	-	-	-	-
	Transmission Cable		mm ²	0.75 ~ 1.50	0.75 ~ 1.50	0.75 ~ 1.50	0.75 ~ 1.50
Refrigerant	Type		-	R410A	R410A	R410A	R410A
	Factory Charging		kg	13.90	13.90	16.10	15.80
Sound	Pressure		dBA	-	-	-	-
	Power			-	-	-	-
External Dimension	New Weight		kg	189.5 + 306.0	189.5 + 306.0	241.0 + 306.0	284.0 + 306.0
	Shipping Weight		kg	205.5 + 325.0	205.5 + 325.0	260.0 + 325.0	303.0 + 325.0
	Net Dimensions (WxHxD)		mm	880x1,695x765 + 1,295x1,695x765	880x1,695x765 + 1,295x1,695x765	(1,295x1,695x765)x2	(1,295x1,695x765)x2
	Shipping Dimensions (WxHxD)		mm	948x1,887x832 + 1,363x1,887x832	948x1,887x832 + 1,363x1,887x832	(1,363x1,887x832)x2	(1,363x1,887x832)x2
Operating Temp.	Cooling		°C	-15.0 ~ 48.0	-15.0 ~ 48.0	-15.0 ~ 48.0	-15.0 ~ 48.0
	Heating		°C	-20.0 ~ 24.0	-20.0 ~ 24.0	-20.0 ~ 24.0	-20.0 ~ 24.0

* Specifications may be subject to change without prior notice for product improvement.

1) Nominal cooling capacities are based on;

- Indoor temperature : 27°C DB, 19°C WB

- Outdoor temperature : 35°C DB, 24°C WB, Equivalent refrigerant piping : 7.5m, Level differences : 0m

2) Nominal heating capacities are based on;

- Indoor temperature : 20°C DB, 15°C WB

- Outdoor temperature : 7°C DB, 6°C WB, Equivalent refrigerant piping : 7.5m, Level differences : 0m

3) Sound pressure was acquired in an anechoic room. Thus actual noise level may be different depending on the installation conditions.

4) If outdoor unit is located in a higher position than indoor unit, level difference is 110m or under.

(If the level difference is higher than 50m, make a decision by PDM kit installation Guide software whether the PDM kit should be installed or not.)

*PDM kit: Pressure Drop Modulation kit

2 Specifications : Heat Recovery

Outdoor

Type			DVM S(NEW)	DVM S(NEW)	DVM S(NEW)	DVM S(NEW)
Model Name			AM400FXVAGR/TK	AM420FXVAGR/TK	AM440FXVAGR/TK	AM460FXVAGR/TK
Power Supply			∅, #, V, Hz	3,4,380-415,50	3,4,380-415,50	3,4,380-415,50
Mode			-	HR	HR	HR
Performance	HP		HP	40.00	42.00	44.00
		Capacity (Nominal)	Cooling	kW	112.00	117.60
	Btu/h			382,200	401,300	420,400
		Heating	kW	126.00	132.30	138.60
Btu/h			429,900	451,400	472,900	
Power	Power Input (Nominal)	Cooling 1)	kW	30.38	32.54	34.70
		Heating 2)	kW	27.80	30.60	33.40
	Current Input (Nominal)	Cooling 1)	A	48.80	52.20	55.60
		Heating 2)	A	44.60	49.10	53.60
	MCA	A	85.00	87.00	89.00	
MFA	A	100.00	100.00	100.00		
COP	EER (Nominal Cooling)		-	3.69	3.61	3.55
	COP (Nominal Heating)		-	4.53	4.32	4.15
	Energy Grade		-	-	-	-
Compressor	Type		-	SSC Scroll x 4	SSC Scroll x 4	SSC Scroll x 4
	Output		kW x n	(6.13x2)x2	(6.13x2) + (6.13x2)	(6.13x2)x2
	Model Name		-	DS-GB066FAVASGx4	DS-GB066FAVASGx4	DS-GB066FAVASGx4
	Oil	Type	-	PVE	PVE	PVE
Fan	Type		-	Propeller	Propeller	Propeller
	Output x n		W	(620.0x2)x2	(620.0x2)x2	(620.0x2)x2
	Air Flow Rate		CMM	290.0x2	290.0x2	290.0x2
			l/s	4,833.3x2	4,833.3x2	4,833.3x2
	External Static	Max.	mmAQ	8.00	8.00	8.00
Pa			78.45	78.45	78.45	
Piping Connections	Liquid Pipe		∅, mm	19.05	19.05	19.05
			∅, inch	3/4"	3/4"	3/4"
	Gas Pipe		∅, mm	41.28	41.28	41.28
			∅, inch	1 5/8"	1 5/8"	1 5/8"
	Discharge Gas Pipe		∅, mm	34.92	34.92	34.92
			∅, inch	1 3/8"	1 3/8"	1 3/8"
	Installation Limitation	Max. Length	m	200 (220)	200 (220)	200 (220)
Max. Height		m	110 (110)	110 (110)	110 (110)	
Field Wiring	Power Source Wire		mm ²	-	-	-
	Transmission Cable		mm ²	0.75 ~ 1.50	0.75 ~ 1.50	0.75 ~ 1.50
Refrigerant	Type		-	R410A	R410A	R410A
	Factory Charging		kg	16.80	16.80	16.80
Sound	Pressure		dBA	-	-	-
	Power			-	-	-
External Dimension	New Weight		kg	306.0x2	306.0x2	306.0x2
	Shipping Weight		kg	325.0x2	325.0x2	325.0x2
	Net Dimensions (WxHxD)		mm	(1,295x1,695x765)x2	(1,295x1,695x765)x2	(1,295x1,695x765)x2
	Shipping Dimensions (WxHxD)		mm	(1,363x1,887x832)x2	(1,363x1,887x832)x2	(1,363x1,887x832)x2
Operating Temp.	Cooling		°C	-15.0 ~ 48.0	-15.0 ~ 48.0	-15.0 ~ 48.0
	Heating		°C	-20.0 ~ 24.0	-20.0 ~ 24.0	-20.0 ~ 24.0

* Specifications may be subject to change without prior notice for product improvement.

1) Nominal cooling capacities are based on;

- Indoor temperature : 27°C DB, 19°C WB

- Outdoor temperature : 35°C DB, 24°C WB, Equivalent refrigerant piping : 7.5m, Level differences : 0m

2) Nominal heating capacities are based on;

- Indoor temperature : 20°C DB, 15°C WB

- Outdoor temperature : 7°C DB, 6°C WB, Equivalent refrigerant piping : 7.5m, Level differences : 0m

3) Sound pressure was acquired in an anechoic room. Thus actual noise level may be different depending on the installation conditions.

4) If outdoor unit is located in a higher position than indoor unit, level difference is 110m or under.

(If the level difference is higher than 50m, make a decision by PDM kit installation Guide software whether the PDM kit should be installed or not.)

*PDM kit: Pressure Drop Modulation kit

2 Specifications : Heat Recovery

Outdoor

Type			DVM S(NEW)	DVM S(NEW)	DVM S(NEW)	DVM S(NEW)
Model Name			AM480FXVAGR/TK	AM500FXVAGR/TK	AM520FXVAGR/TK	AM540FXVAGR/TK
Power Supply			∅, #, V, Hz	3,4,380-415,50	3,4,380-415,50	3,4,380-415,50
Mode			-	HR	HR	HR
Performance	HP		HP	48.00	50.00	52.00
		Capacity (Nominal)	Cooling	kW	135.20	140.20
	Heating		Btu/h	461,300	478,400	496,800
				kW	152.10	157.50
			Btu/h	519,000	537,400	558,900
Power	Power Input (Nominal)	Cooling 1)	kW	34.65	36.75	38.63
		Heating 2)	kW	34.90	36.90	37.30
	Current Input (Nominal)	Cooling 1)	A	55.60	58.90	62.00
		Heating 2)	A	56.00	59.20	59.90
	MCA	A	94.50	101.50	108.60	
MFA	A	125.00	125.00	125.00		
COP	EER (Nominal Cooling)		-	3.90	3.81	3.77
	COP (Nominal Heating)		-	4.36	4.27	4.39
	Energy Grade		-	-	-	-
Compressor	Type		-	SSC Scroll x 4	SSC Scroll x 5	SSC Scroll x 5
	Output		kW x n	(6.13) + (6.13) + (6.13x2)	(6.13) + (4.96x2) + (6.13x2)	(6.13) + (6.13x2) + (6.13x2)
	Model Name		-	DS-GB066FAVASGx4	DS-GB052FAVBSGx2+ DS-GB066FAVASGx3	DS-GB066FAVASGx5
	Oil	Type	-	PVE	PVE	PVE
Fan	Type		-	Propeller	Propeller	Propeller
	Output x n		W	830.0 + (620.0x2)x2	830.0 + (620.0x2)x2	830.0 + (620.0x2)x2
	Air Flow Rate		CMM	220.0 + 255.0 + 290.0	220.0 + 255.0 + 290.0	220.0 + 290.0x2
			l/s	3,666.7 + 4,250.0 + 4,833.3	3,666.7 + 4,250.0 + 4,833.3	3,666.7 + 4,833.3x2
	External Static	Max.	mmAQ	8.00	8.00	8.00
Pa			78.45	78.45	78.45	
Piping Connections	Liquid Pipe		∅, mm	19.05	19.05	19.05
			∅, inch	3/4"	3/4"	3/4"
	Gas Pipe		∅, mm	41.28	41.28	41.28
			∅, inch	1 5/8"	1 5/8"	1 5/8"
	Discharge Gas Pipe		∅, mm	34.92	34.92	34.92
			∅, inch	1 3/8"	1 3/8"	1 3/8"
	Installation Limitation	Max. Length	m	200 (220)	200 (220)	200 (220)
Max. Height		m	110 (110)	110 (110)	110 (110)	
Field Wiring	Power Source Wire		mm ²	-	-	-
	Transmission Cable		mm ²	0.75 ~ 1.50	0.75 ~ 1.50	0.75 ~ 1.50
Refrigerant	Type		-	R410A	R410A	R410A
	Factory Charging		kg	21.60	21.30	22.60
Sound	Pressure		dBA	-	-	-
	Power			-	-	-
External Dimension	New Weight		kg	189.5 + 241.0 + 306.0	189.5 + 284.0 + 306.0	189.5 + 306.0x2
	Shipping Weight		kg	205.5 + 260.0 + 325.0	205.5 + 303.0 + 325.0	205.5 + 325.0x2
	Net Dimensions (WxHxD)		mm	880x1,695x765 + (1,295x1,695x765)x2	880x1,695x765 + (1,295x1,695x765)x2	880x1,695x765 + (1,295x1,695x765)x2
	Shipping Dimensions (WxHxD)		mm	948x1,887x832 + (1,363x1,887x832)x2	948x1,887x832 + (1,363x1,887x832)x2	948x1,887x832 + (1,363x1,887x832)x2
Operating Temp.	Cooling		°C	-15.0 ~ 48.0	-15.0 ~ 48.0	-15.0 ~ 48.0
	Heating		°C	-20.0 ~ 24.0	-20.0 ~ 24.0	-20.0 ~ 24.0

* Specifications may be subject to change without prior notice for product improvement.

1) Nominal cooling capacities are based on;

- Indoor temperature : 27°C DB, 19°C WB

- Outdoor temperature : 35°C DB, 24°C WB, Equivalent refrigerant piping : 7.5m, Level differences : 0m

2) Nominal heating capacities are based on;

- Indoor temperature : 20°C DB, 15°C WB

- Outdoor temperature : 7°C DB, 6°C WB, Equivalent refrigerant piping : 7.5m, Level differences : 0m

3) Sound pressure was acquired in an anechoic room. Thus actual noise level may be different depending on the installation conditions.

4) If outdoor unit is located in a higher position than indoor unit, level difference is 110m or under.

(If the level difference is higher than 50m, make a decision by PDM kit installation Guide software whether the PDM kit should be installed or not.)

*PDM kit: Pressure Drop Modulation kit

2 Specifications : Heat Recovery

Outdoor

Type			DVM S(NEW)	DVM S(NEW)	DVM S(NEW)	DVM S(NEW)
Model Name			AM560FXVAGR/TK	AM580FXVAGR/TK	AM600FXVAGR/TK	AM620FXVAGR/TK
Power Supply			∅, #, V, Hz	3,4,380-415,50	3,4,380-415,50	3,4,380-415,50
Mode			-	HR	HR	HR
Performance	HP		HP	56.00	58.00	60.00
		Capacity (Nominal)	Cooling	kW	156.80	163.20
	Heating		Btu/h	535,000	556,900	573,900
				kW	176.40	183.60
			Btu/h	601,900	626,500	644,900
Power	Power Input (Nominal)	Cooling 1)	kW	43.10	43.60	45.70
		Heating 2)	kW	42.10	42.90	44.90
	Current Input (Nominal)	Cooling 1)	A	69.10	69.90	73.20
		Heating 2)	A	67.60	68.80	72.00
	MCA	A	114.00	114.00	121.00	
MFA	A	125.00	125.00	150.00		
COP	EER (Nominal Cooling)		-	3.64	3.74	3.68
	COP (Nominal Heating)		-	4.19	4.28	4.21
	Energy Grade		-	-	-	-
Compressor	Type		-	SSC Scroll x 5	SSC Scroll x 5	SSC Scroll x 6
	Output		kW x n	(6.13) + (6.13x2)x2	(6.13) + (6.13x2)x2	(4.96x2) + (6.13x2)x2
	Model Name		-	DS-GB066FAVASGx5	DS-GB066FAVASGx5	DS-GB052FAVBSGx2+ DS-GB066FAVASGx4
	Oil	Type	-	PVE	PVE	PVE
Fan	Type		-	Propeller	Propeller	Propeller
	Output x n		W	830.0 + (620.0x2)x2	(620.0x2)x3	(620.0x2)x3
	Air Flow Rate		CMM	220.0 + 290.0x2	255.0 + 290.0x2	255.0 + 290.0x2
			l/s	3,666.7 + 4,833.3x2	4,250.0 + 4,833.3x2	4,250.0 + 4,833.3x2
	External Static	Max.	mmAQ	8.00	8.00	8.00
Pa			78.45	78.45	78.45	
Piping Connections	Liquid Pipe		∅, mm	19.05	19.05	19.05
			∅, inch	3/4"	3/4"	7/8"
	Gas Pipe		∅, mm	41.28	41.28	41.28
			∅, inch	1 5/8"	1 5/8"	2 1/8"
	Discharge Gas Pipe		∅, mm	34.92	34.92	34.92
			∅, inch	1 3/8"	1 3/8"	1 3/8"
Installation Limitation	Max. Length	m	200 (220)	200 (220)	200 (220)	
	Max. Height	m	110 (110)	110 (110)	110 (110)	
Field Wiring	Power Source Wire		mm ²	-	-	-
	Transmission Cable		mm ²	0.75 ~ 1.50	0.75 ~ 1.50	0.75 ~ 1.50
Refrigerant	Type		-	R410A	R410A	R410A
	Factory Charging		kg	22.30	24.50	24.20
Sound	Pressure		dBA	-	-	-
	Power			-	-	-
External Dimension	New Weight		kg	189.5 + 306.0x2	241.0 + 306.0x2	284.0 + 306.0x2
	Shipping Weight		kg	205.5 + 325.0x2	260.0 + 325.0x2	303.0 + 325.0x2
	Net Dimensions (WxHxD)		mm	880x1,695x765 + (1,295x1,695x765)x2	(1,295x1,695x765)x3	(1,295x1,695x765)x3
	Shipping Dimensions (WxHxD)		mm	948x1,887x832 + (1,363x1,887x832)x2	(1,363x1,887x832)x3	(1,363x1,887x832)x3
Operating Temp.	Cooling		°C	-15.0 ~ 48.0	-15.0 ~ 48.0	-15.0 ~ 48.0
	Heating		°C	-20.0 ~ 24.0	-20.0 ~ 24.0	-20.0 ~ 24.0

* Specifications may be subject to change without prior notice for product improvement.

1) Nominal cooling capacities are based on;

- Indoor temperature : 27°C DB, 19°C WB

- Outdoor temperature : 35°C DB, 24°C WB, Equivalent refrigerant piping : 7.5m, Level differences : 0m

2) Nominal heating capacities are based on;

- Indoor temperature : 20°C DB, 15°C WB

- Outdoor temperature : 7°C DB, 6°C WB, Equivalent refrigerant piping : 7.5m, Level differences : 0m

3) Sound pressure was acquired in an anechoic room. Thus actual noise level may be different depending on the installation conditions.

4) If outdoor unit is located in a higher position than indoor unit, level difference is 110m or under.

(If the level difference is higher than 50m, make a decision by PDM kit installation Guide software whether the PDM kit should be installed or not.)

*PDM kit: Pressure Drop Modulation kit

2 Specifications : Heat Recovery

Outdoor

Type			DVM S(NEW)	DVM S(NEW)	DVM S(NEW)	DVM S(NEW)
Model Name			AM640FXVAGR/EU	AM660FXVAGR/TK	AM680FXVAGR/TK	AM700FXVAGR/TK
Power Supply			Ø, #, V, Hz	3,4,380-415,50	3,4,380-415,50	3,4,380-415,50
Mode			-	HR	HR	HR
Performance	HP		HP	64.00	66.00	68.00
			kW	179.20	184.80	190.40
	Capacity (Nominal)	Cooling	Btu/h	611,500	630,600	649,700
		Heating	kW	201.60	207.90	214.20
		Btu/h	687,900	709,400	730,900	
Power	Power Input (Nominal)	Cooling 1)	kW	49.89	52.05	51.50
		Heating 2)	kW	47.30	50.10	50.80
	Current Input (Nominal)	Cooling 1)	A	80.00	83.40	82.60
		Heating 2)	A	75.90	80.40	81.60
	MCA	A	131.50	133.50	139.00	
MFA	A	150.00	150.00	175.00		
COP	EER (Nominal Cooling)		-	3.59	3.55	3.70
	COP (Nominal Heating)		-	4.26	4.15	4.22
	Energy Grade		-	ESEER 6.35	-	-
Compressor	Type		-	SSC Scroll x 6	SSC Scroll x 6	SSC Scroll x 6
	Output		kW x n	(6.39x2) + (6.39x2)x2	(6.13x2)x3	(6.13)x2 + (6.13x2)x2
	Model Name		-	DS-GB066FAVBSGx6	DS-GB066FAVASGx6	DS-GB066FAVASGx6
	Oil	Type	-	PVE	PVE	PVE
Fan	Type		-	Propeller	Propeller	Propeller
	Output x n		W	(620.0x2)x3	(620.0x2)x3	(830.0)x2 + (620.0x2)x2
	Air Flow Rate		CMM	290.0x3	290.0x3	220.0x2 + 290.0x2
			l/s	4,833.3x3	4,833.3x3	3,666.7x2 + 4,833.3x2
	External Static	Max.	mmAQ	8.00	8.00	8.00
Pa			78.45	78.45	78.45	
Piping Connections	Liquid Pipe		Ø, mm	22.22	22.22	22.22
			Ø, inch	7/8"	7/8"	7/8"
	Gas Pipe		Ø, mm	53.98	53.98	53.98
			Ø, inch	2 1/8"	2 1/8"	2 1/8"
	Discharge Gas Pipe		Ø, mm	41.28	41.28	41.28
			Ø, inch	1 5/8"	1 5/8"	1 5/8"
Installation Limitation	Max. Length	m	200 (220)	200 (220)	200 (220)	
	Max. Height	m	110 (110)	110 (110)	110 (110)	
Field Wiring	Power Source Wire		mm ²	-	-	-
	Transmission Cable		mm ²	0.75 ~ 1.50	0.75 ~ 1.50	0.75 ~ 1.50
Refrigerant	Type		-	R410A	R410A	R410A
	Factory Charging		kg	25.20	25.20	27.80
Sound	Pressure		dBA	70.00	-	-
	Power			91.00	-	-
External Dimension	New Weight		kg	306.0x3	306.0x3	189.5x2 + 306.0x2
	Shipping Weight		kg	325.0x3	325.0x3	205.5x2 + 325.0x2
	Net Dimensions (WxHxD)		mm	(1,295x1,695x765)x3	(1,295x1,695x765)x3	(880x1,695x765)x2 + (1,295x1,695x765)x2
	Shipping Dimensions (WxHxD)		mm	(1,363x1,887x832)x3	(1,363x1,887x832)x3	(948x1,887x832)x2 + (1,363x1,887x832)x2
Operating Temp.	Cooling		°C	-15.0 ~ 48.0	-15.0 ~ 48.0	-15.0 ~ 48.0
	Heating		°C	-25.0 ~ 24.0	-20.0 ~ 24.0	-20.0 ~ 24.0

* Specifications may be subject to change without prior notice for product improvement.

1) Nominal cooling capacities are based on;

- Indoor temperature : 27°C DB, 19°C WB

- Outdoor temperature : 35°C DB, 24°C WB, Equivalent refrigerant piping : 7.5m, Level differences : 0m

2) Nominal heating capacities are based on;

- Indoor temperature : 20°C DB, 15°C WB

- Outdoor temperature : 7°C DB, 6°C WB, Equivalent refrigerant piping : 7.5m, Level differences : 0m

3) Sound pressure was acquired in an anechoic room. Thus actual noise level may be different depending on the installation conditions.

4) If outdoor unit is located in a higher position than indoor unit, level difference is 110m or under.

(If the level difference is higher than 50m, make a decision by PDM kit installation Guide software whether the PDM kit should be installed or not.)

*PDM kit: Pressure Drop Modulation kit

2 Specifications : Heat Recovery

Outdoor

Type			DVM S(NEW)	DVM S(NEW)	DVM S(NEW)	DVM S(NEW)	
Model Name			AM720FXVAGR/TK	AM740FXVAGR/TK	AM760FXVAGR/TK	AM780FXVAGR/TK	
Power Supply			∅, #, V, Hz	3,4,380-415,50	3,4,380-415,50	3,4,380-415,50	
Mode			-	HR	HR	HR	
Performance	HP		HP	72.00	74.00	76.00	
		Capacity (Nominal)	Cooling	kW	201.80	207.20	212.80
	Heating		Btu/h	688,600	707,000	726,100	
				kW	226.80	233.10	239.40
			Btu/h	773,900	795,400	816,900	
Power	Power Input (Nominal)	Cooling 1)	kW	54.10	55.98	58.29	
		Heating 2)	kW	53.60	54.00	56.00	
	Current Input (Nominal)	Cooling 1)	A	86.70	89.80	93.50	
		Heating 2)	A	86.00	86.70	89.90	
	MCA	A	146.00	153.10	156.50		
MFA	A	175.00	175.00	175.00			
COP	EER (Nominal Cooling)		-	3.73	3.70	3.65	
	COP (Nominal Heating)		-	4.23	4.32	4.28	
	Energy Grade		-	-	-	-	
Compressor	Type		-	SSC Scroll x 7	SSC Scroll x 7	SSC Scroll x 7	
	Output		kW x n	(6.13) + (4.96x2) + (6.13x2)x2	(6.13) + (6.13x2) + (6.13x2)x2	(6.13) + (6.13x2) + (6.13x2)x2	(6.13) + (6.13x2)x3
	Model Name		-	DS-GB052FAVBSGx2+ DS-GB066FAVASGx5	DS-GB066FAVASGx7	DS-GB066FAVASGx7	DS-GB066FAVASGx7
	Oil	Type	-	PVE	PVE	PVE	PVE
Fan	Type		-	Propeller	Propeller	Propeller	Propeller
	Output x n		W	830.0 + (620.0x2)x3	830.0 + (620.0x2)x3	830.0 + (620.0x2)x3	830.0 + (620.0x2)x3
	Air Flow Rate		CMM	220.0 + 255.0 + 290.0x2	220.0 + 290.0x3	220.0 + 290.0x3	220.0 + 290.0x3
			l/s	3,666.7 + 4,250.0 + 4,833.3x2	3,666.7 + 4,833.3x3	3,666.7 + 4,833.3x3	3,666.7 + 4,833.3x3
	External Static	Max.	mmAQ	8.00	8.00	8.00	8.00
Pa			78.45	78.45	78.45	78.45	
Piping Connections	Liquid Pipe		∅, mm	22.22	22.22	22.22	22.22
			∅, inch	7/8"	7/8"	7/8"	7/8"
	Gas Pipe		∅, mm	53.98	53.98	53.98	53.98
			∅, inch	2 1/8"	2 1/8"	2 1/8"	2 1/8"
	Discharge Gas Pipe		∅, mm	41.28	41.28	41.28	41.28
			∅, inch	1 5/8"	1 5/8"	1 5/8"	1 5/8"
	Installation Limitation	Max. Length	m	200 (220)	200 (220)	200 (220)	200 (220)
Max. Height			m	110 (110)	110 (110)	110 (110)	110 (110)
Field Wiring	Power Source Wire		mm ²	-	-	-	-
	Transmission Cable		mm ²	0.75 ~ 1.50	0.75 ~ 1.50	0.75 ~ 1.50	0.75 ~ 1.50
Refrigerant	Type		-	R410A	R410A	R410A	R410A
	Factory Charging		kg	29.70	31.00	30.70	30.70
Sound	Pressure		dBA	-	-	-	-
	Power			-	-	-	-
External Dimension	New Weight		kg	189.5 + 284.0 + 306.0x2	189.5 + 306.0x3	189.5 + 306.0x3	189.5 + 306.0x3
	Shipping Weight		kg	205.5 + 303.0 + 325.0x2	205.5 + 325.0x3	205.5 + 325.0x3	205.5 + 325.0x3
	Net Dimensions (WxHxD)		mm	880x1,695x765 + (1,295x1,695x765)x3	880x1,695x765 + (1,295x1,695x765)x3	880x1,695x765 + (1,295x1,695x765)x3	880x1,695x765 + (1,295x1,695x765)x3
	Shipping Dimensions (WxHxD)		mm	948x1,887x832 + (1,363x1,887x832)x3	948x1,887x832 + (1,363x1,887x832)x3	948x1,887x832 + (1,363x1,887x832)x3	948x1,887x832 + (1,363x1,887x832)x3
Operating Temp.	Cooling		°C	-15.0 ~ 48.0	-15.0 ~ 48.0	-15.0 ~ 48.0	-15.0 ~ 48.0
	Heating		°C	-20.0 ~ 24.0	-20.0 ~ 24.0	-20.0 ~ 24.0	-20.0 ~ 24.0

* Specifications may be subject to change without prior notice for product improvement.

1) Nominal cooling capacities are based on;

- Indoor temperature : 27°C DB, 19°C WB

- Outdoor temperature : 35°C DB, 24°C WB, Equivalent refrigerant piping : 7.5m, Level differences : 0m

2) Nominal heating capacities are based on;

- Indoor temperature : 20°C DB, 15°C WB

- Outdoor temperature : 7°C DB, 6°C WB, Equivalent refrigerant piping : 7.5m, Level differences : 0m

3) Sound pressure was acquired in an anechoic room. Thus actual noise level may be different depending on the installation conditions.

4) If outdoor unit is located in a higher position than indoor unit, level difference is 110m or under.

(If the level difference is higher than 50m, make a decision by PDM kit installation Guide software whether the PDM kit should be installed or not.)

*PDM kit: Pressure Drop Modulation kit

2 Specifications : Heat Recovery

Outdoor

Type			DVM S(NEW)	
Model Name			AM800FXVAGR/TK	
Power Supply		Ø, #, V, Hz	3,4,380-415,50	
Mode			HR	
Performance	HP	HP	80.00	
		Capacity (Nominal)	Cooling	kW
	Btu/h			767,000
	Heating		kW	252.90
			Btu/h	862,900
Power	Power Input (Nominal)	Cooling 1)	kW	60.95
		Heating 2)	kW	59.60
	Current Input (Nominal)	Cooling 1)	A	97.70
		Heating 2)	A	95.60
	MCA	A	158.50	
	MFA	A	175.00	
COP	EER (Nominal Cooling)		-	3.69
	COP (Nominal Heating)		-	4.24
	Energy Grade		-	-
			-	-
Compressor	Type		-	SSC Scroll x 7
	Output		kW x n	(6.13) + (6.13x2)x3
	Model Name		-	DS-GB066FAVASGx7
	Oil	Type	-	PVE
Fan	Type		-	Propeller
	Output x n		W	(620.0x2)x4
	Air Flow Rate		CMM	255.0 + 290.0x3
			l/s	4,250.0 + 4,833.3x3
	External Static	Max.	mmAQ	8.00
Pa			78.45	
Piping Connections	Liquid Pipe		Ø, mm	22.22
			Ø, inch	7/8"
	Gas Pipe		Ø, mm	53.98
			Ø, inch	2 1/8"
	Discharge Gas Pipe		Ø, mm	41.28
			Ø, inch	1 5/8"
	Installation Limitation	Max. Length	m	200 (220)
		Max. Height	m	110 (110)
Field Wiring	Power Source Wire		mm ²	-
	Transmission Cable		mm ²	0.75 ~ 1.50
Refrigerant	Type		-	R410A
	Factory Charging		kg	32.90
Sound	Pressure		dBA	-
	Power			-
External Dimension	New Weight		kg	241.0 + 306.0x3
	Shipping Weight		kg	260.0 + 325.0x3
	Net Dimensions (WxHxD)		mm	(1,295x1,695x765)x4
	Shipping Dimensions (WxHxD)		mm	(1,363x1,887x832)x4
Operating Temp.	Cooling		°C	-15.0 ~ 48.0
	Heating		°C	-20.0 ~ 24.0

* Specifications may be subject to change without prior notice for product improvement.

1) Nominal cooling capacities are based on;

- Indoor temperature : 27°C DB, 19°C WB

- Outdoor temperature : 35°C DB, 24°C WB, Equivalent refrigerant piping : 7.5m, Level differences : 0m

2) Nominal heating capacities are based on;

- Indoor temperature : 20°C DB, 15°C WB

- Outdoor temperature : 7°C DB, 6°C WB, Equivalent refrigerant piping : 7.5m, Level differences : 0m

3) Sound pressure was acquired in an anechoic room. Thus actual noise level may be different depending on the installation conditions.

4) If outdoor unit is located in a higher position than indoor unit, level difference is 110m or under.

(If the level difference is higher than 50m, make a decision by PDM kit installation Guide software whether the PDM kit should be installed or not.)

*PDM kit: Pressure Drop Modulation kit

3 Operation limit

Cooling

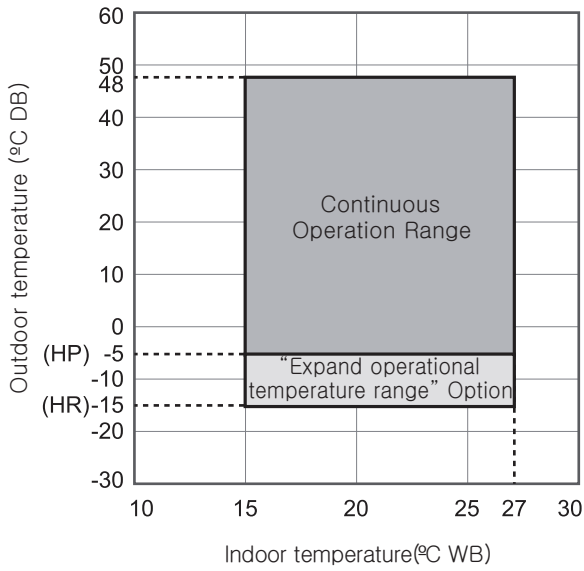

Heating

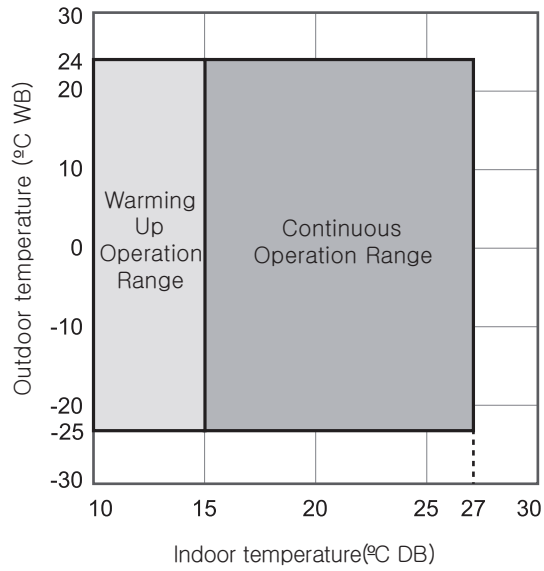

Defrosting correction factor

On heating operation, frost can be formed on heat exchanger according to outdoor temperature. (Frost on heat exchanger results in decreasing the performance.)
 To remove frost on heat exchanger of outdoor unit, defrost operation is carried out periodically.
 During defrost operation, capacity of outdoor unit may decrease.
 The decrement is not considered to the individual capacity tables.

Outdoor temperature (°C, DB)	-10	-8	-6	-4	-2	0	2	5	7
Capacity coefficient	0.99	0.98	0.96	0.95	0.91	0.88	0.86	0.91	1.00

$$\text{Corrected Heating Capacity} = \text{Heating Capacity} \times \text{Capacity Coefficient}$$

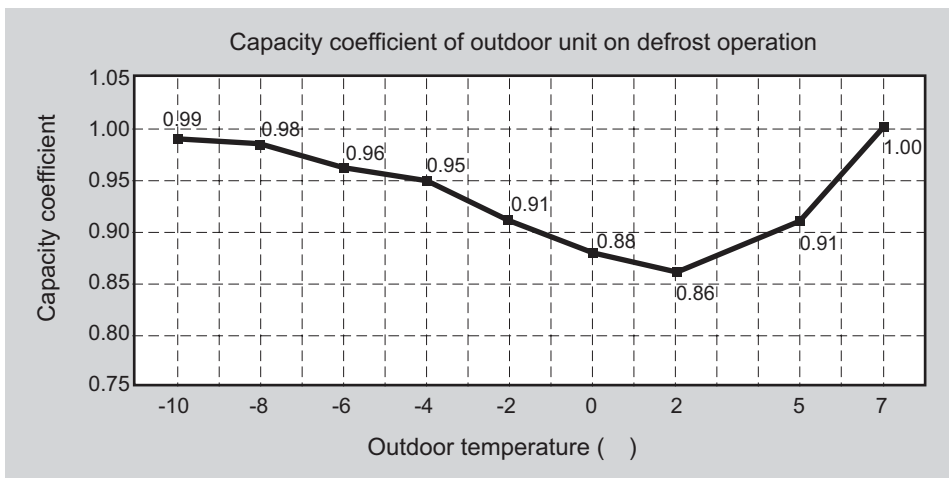

4 Dimensional drawing

Heat Pump

AM080FXVAGH/TK, AM100FXVAGH/TK, AM120FXVAGH/TK

Units : mm / inches

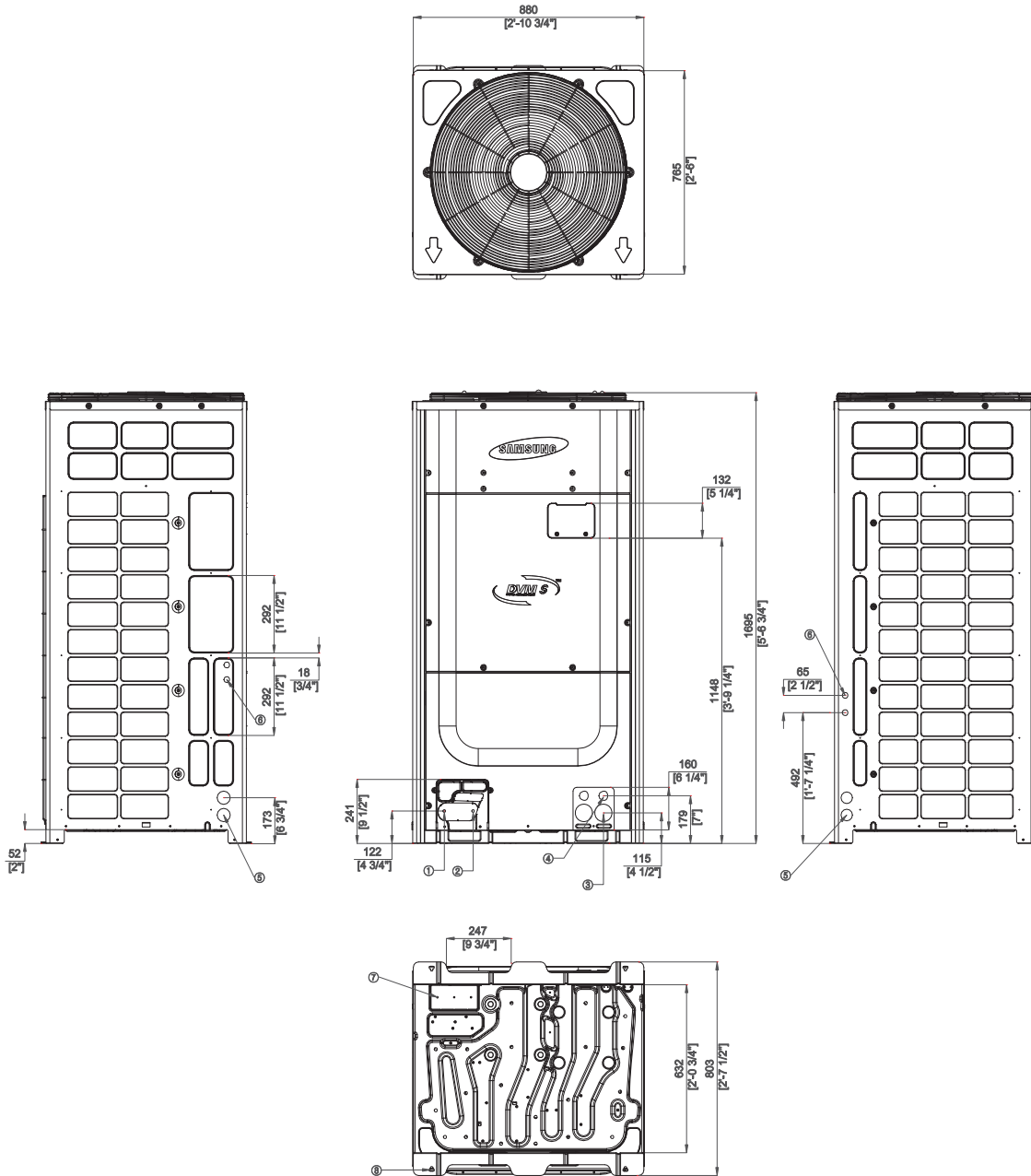

Table of descriptions

1	Refrigerant gas pipe	7	Knock-out Hole for Ref. Piping
2	Refrigerant liquid pipe	8	Anchor Bolt Hole
3	Power wiring conduit	9	
4	Communication wiring conduit	10	
5	Power wiring conduit	11	
6	Communication wiring conduit	12	

4 Dimensional drawing

Heat Pump

AM140FXVAGH/TK, AM160FXVAGH/TK, AM180FXVAGH/TK, AM200FXVAGH/TK, AM220FXVAGH/TK, AM240HXVAGH/TK, AM260HXVAGH/TK

Units : mm / inches

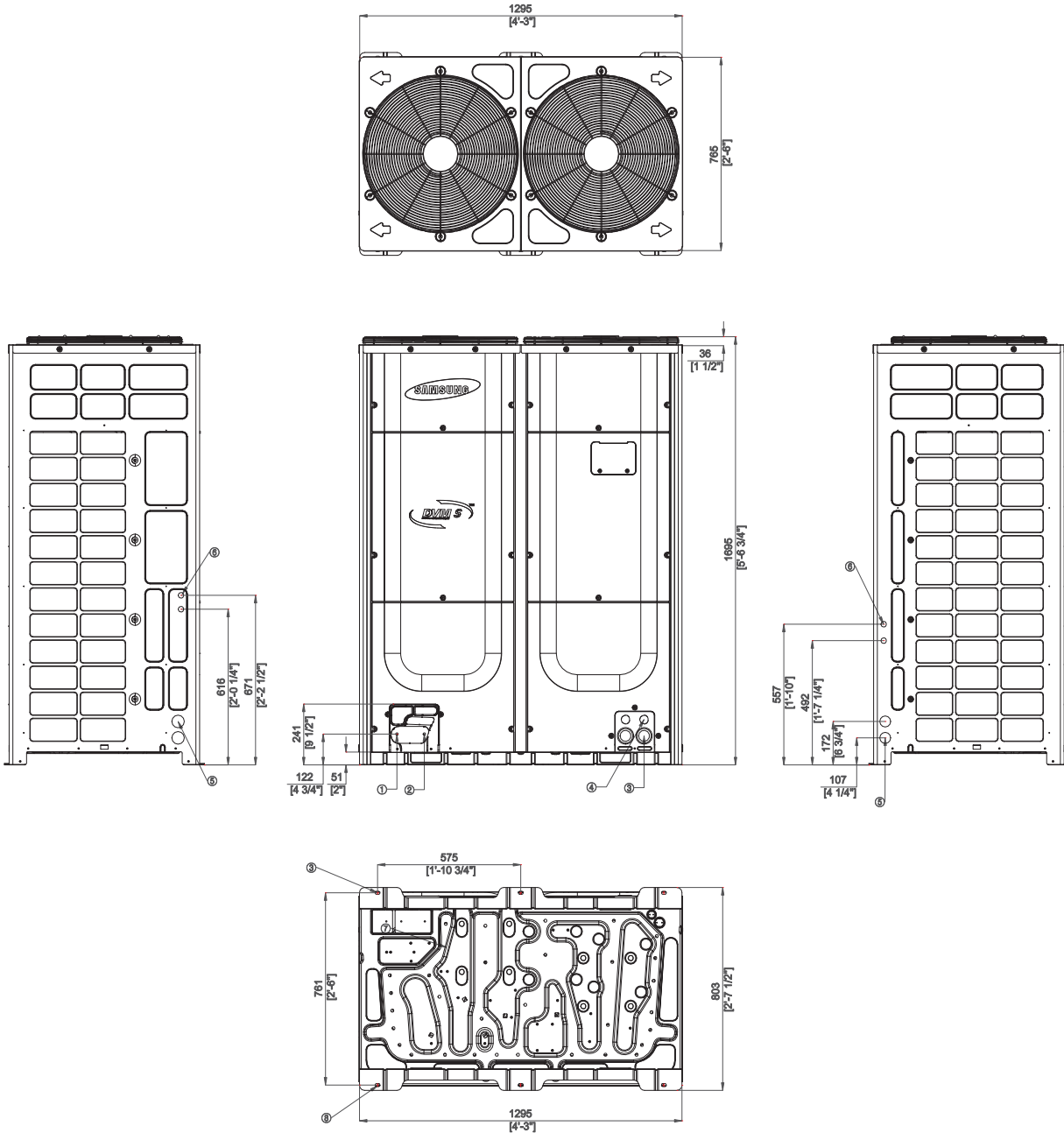

Table of descriptions

1	Gas Ref. pipe	7	Knock-out Hole for Ref. Piping
2	Liquid Ref. pipe	8	Anchor Bolt Hole
3	Power wiring conduit	9	
4	Communication wiring conduit	10	
5	Power wiring conduit	11	
6	Communication wiring conduit	12	

4 Dimensional drawing

Heat Recovery

AM080FXVAGR/TK, AM100FXVAGR/TK, AM120FXVAGR/TK

Units : mm / inches

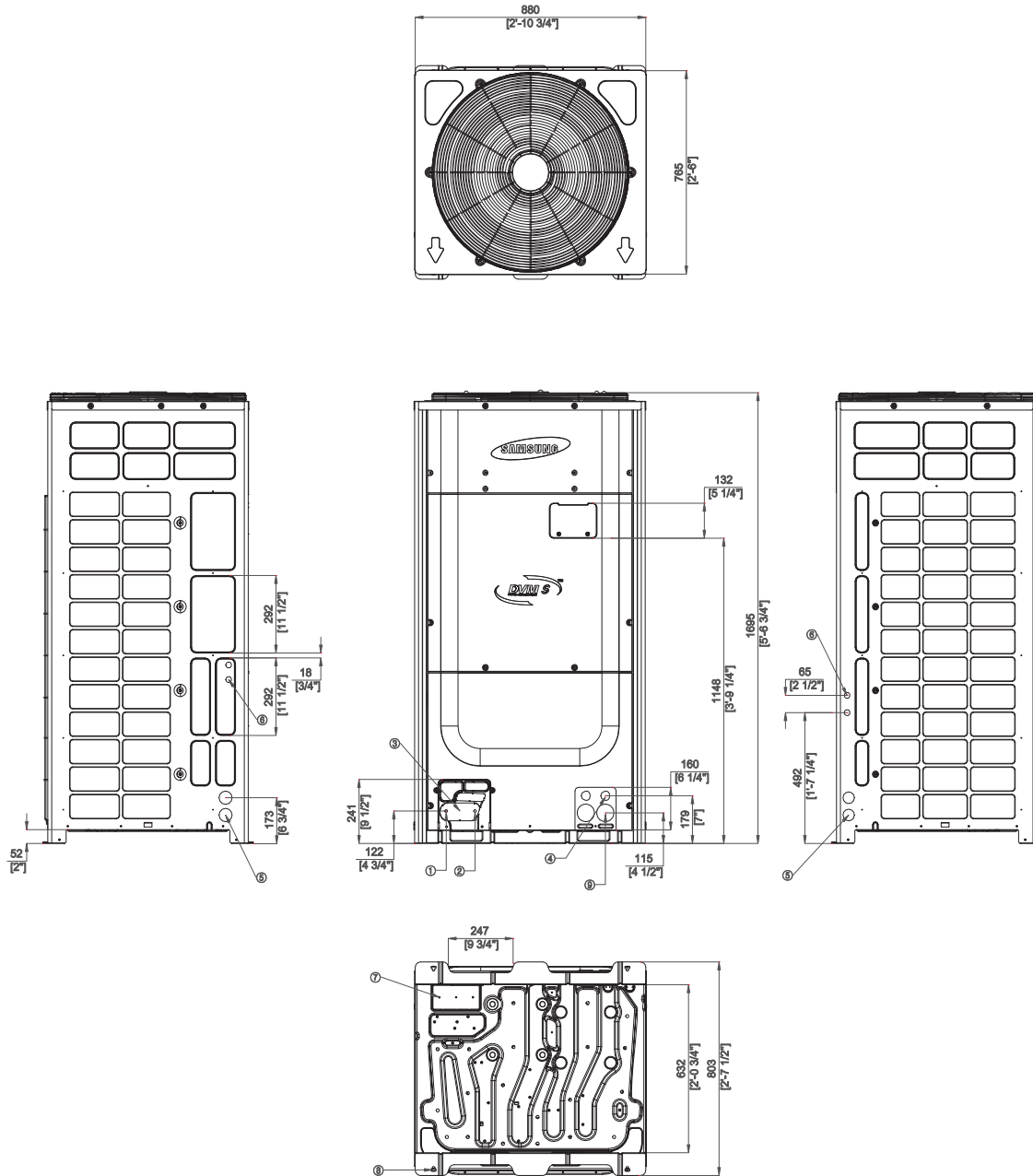

Table of descriptions

1	Low pressure gas pipe	7	Knock-out Hole for Ref. Piping
2	High pressure gas pipe	8	Anchor Bolt Hole
3	Liquid pipe	9	Power wiring conduit
4	Communication wiring conduit	10	
5	Power wiring conduit	11	
6	Communication wiring conduit	12	

4 Dimensional drawing

Heat Recovery

AM140FXVAGR/TK, AM160FXVAGR/TK, AM180FXVAGR/TK, AM200FXVAGR/TK, AM220FXVAGR/TK

Units : mm / inches

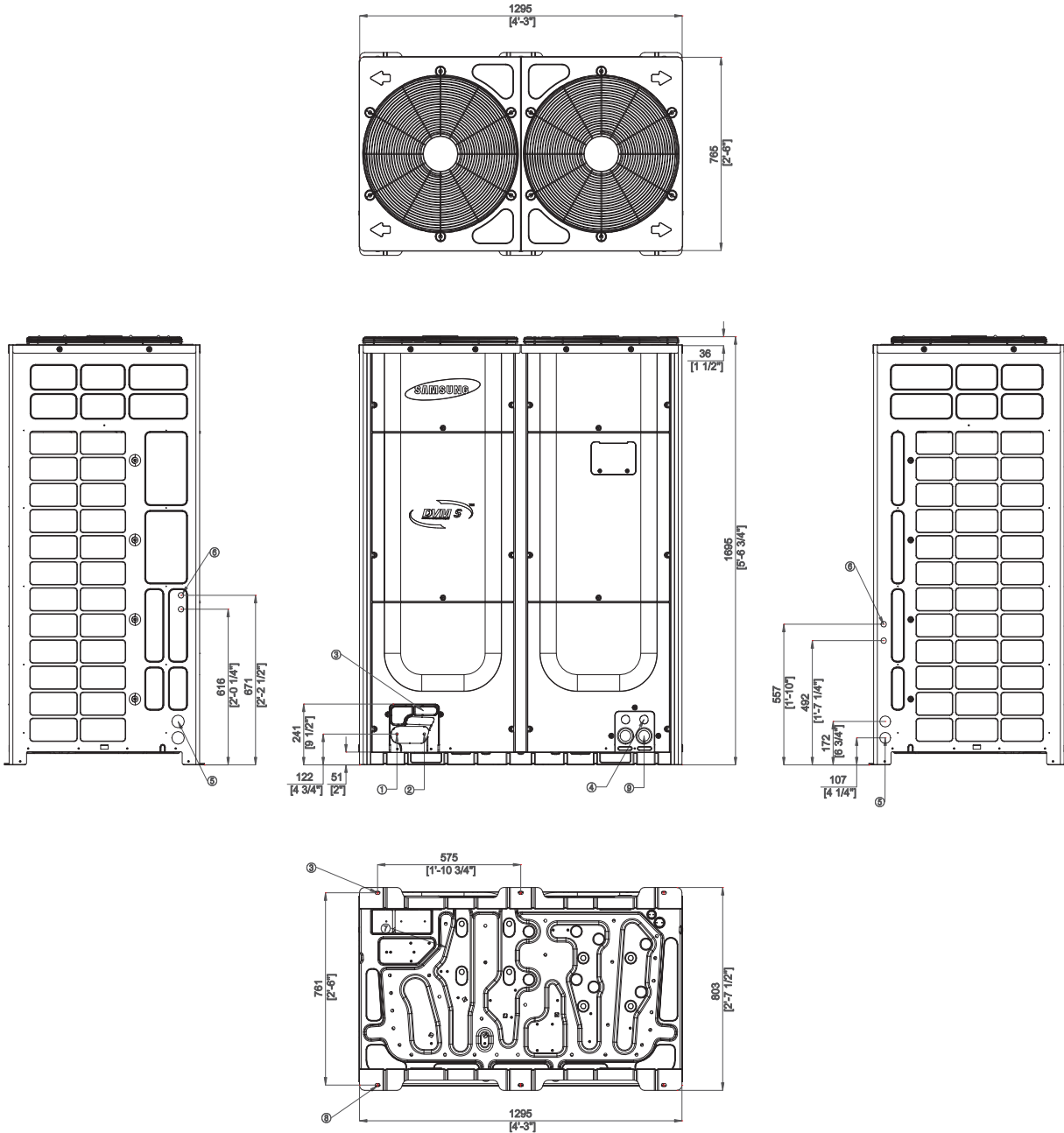

Table of descriptions

1	Low Pressure Gas Ref. pipe	7	Knock-out Hole for Ref. Piping
2	High Pressure Gas Ref. pipe	8	Anchor Bolt Hole
3	Liquid Ref. pipe	9	Power wiring conduit
4	Communication wiring conduit	10	
5	Power wiring conduit	11	
6	Communication wiring conduit	12	

5 Electrical wiring diagram

Outdoor

AM080~220FXVAGH/TK, AM080~220FXVAGR/TK

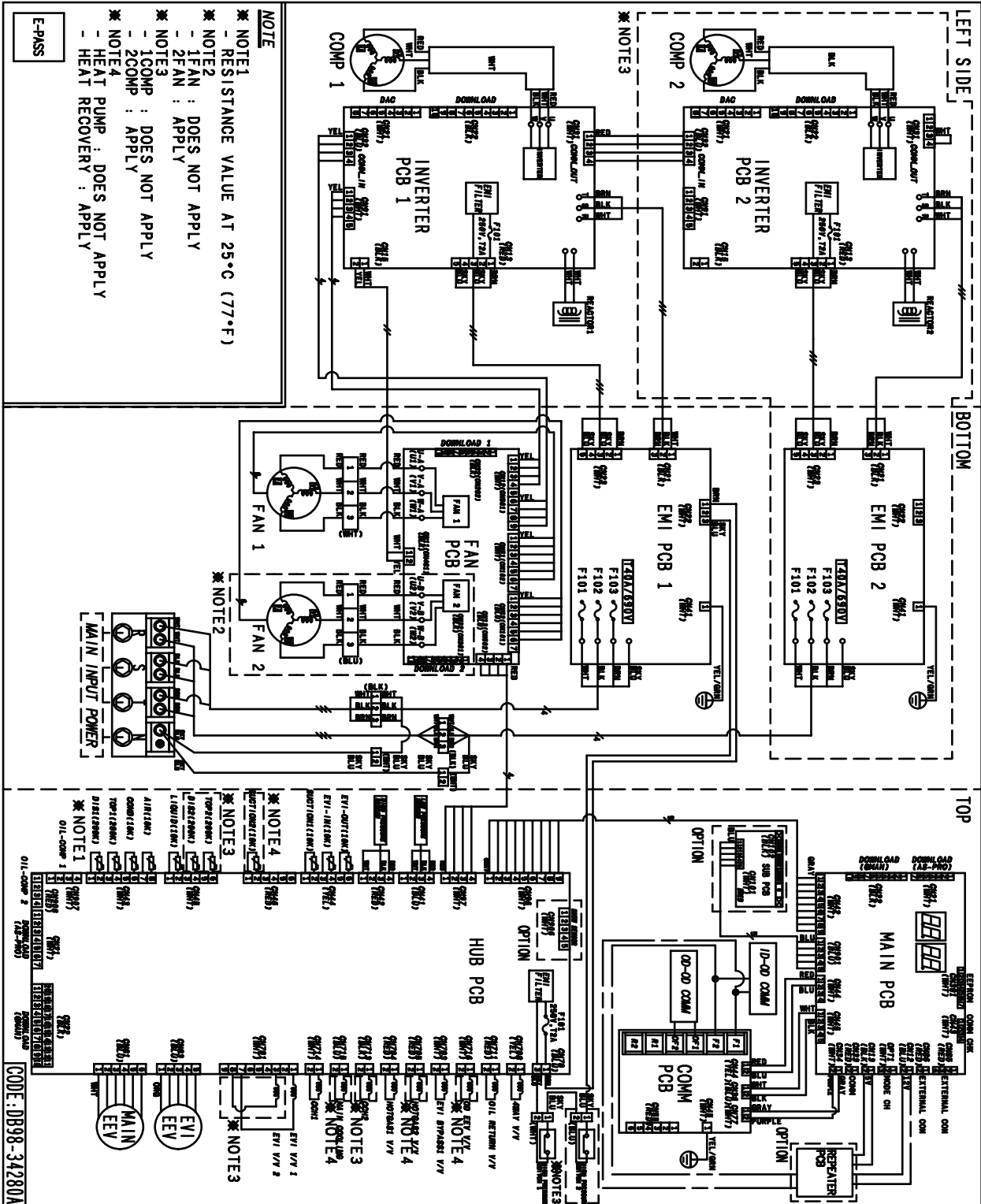

6 Sound pressure level

Outdoor

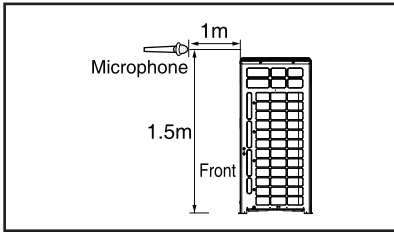

Unit: dB(A)

Model	Pressure
AM080FXVAG * /TK	57.0
AM100FXVAG * /TK	58.0
AM120FXVAG * /TK	62.0
AM140FXVAG * /TK	61.0

Note

Measuring place: Anechoic chamber (conversion value)

These operation values were obtained in an anechoic room. Sound pressure level will vary depending on a factors such as the construction of the particular room where the equipment is installed.

Operation sound level may differ depending on operation and ambient conditions.

NC curve

1) AM080FXVAG * /TK

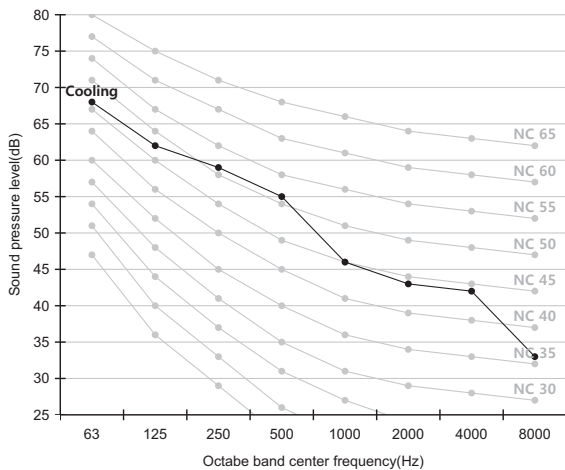

2) AM100FXVAG * /TK

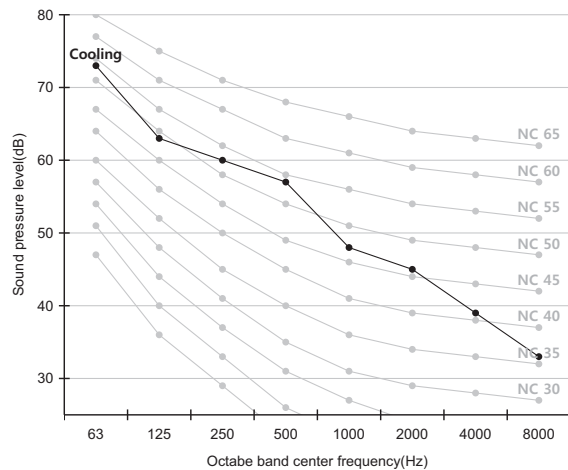

3) AM120FXVAG * /TK

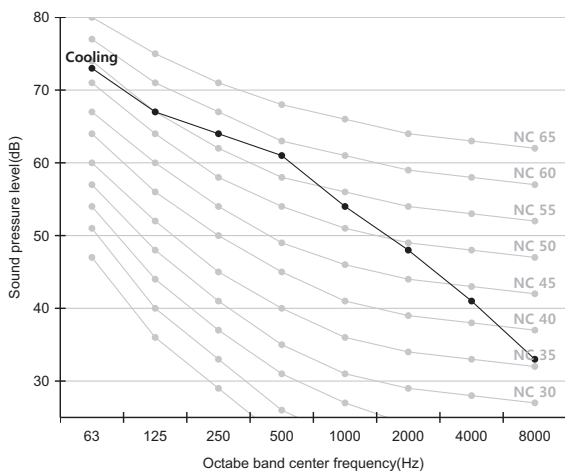

4) AM140FXVAG * /TK

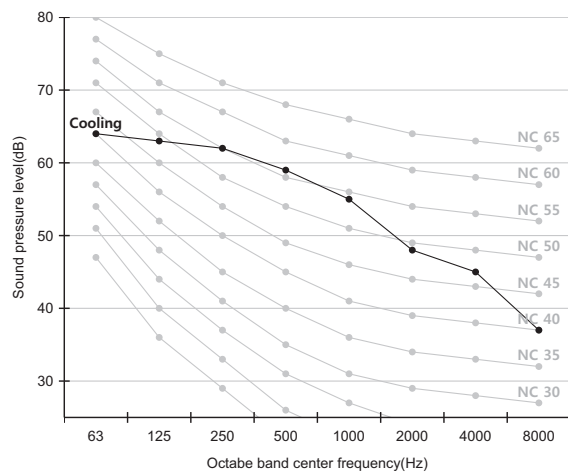

6 Sound pressure level

Outdoor

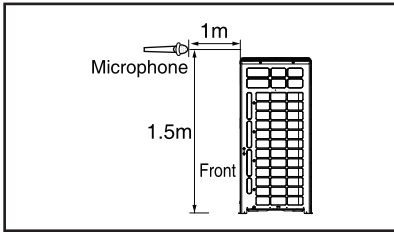

Unit: dB(A)

Model	Pressure
AM160FXVAG * /TK	63.0
AM180FXVAG * /TK	64.0
AM200FXVAG * /TK	65.0
AM220FXVAG * /TK	66.0

Note

Measuring place: Anechoic chamber (conversion value)

These operation values were obtained in an anechoic room. Sound pressure level will vary depending on a factors such as the construction of the particular room where the equipment is installed.

Operation sound level may differ depending on operation and ambient conditions.

NC curve

1) AM160FXVAG * /TK

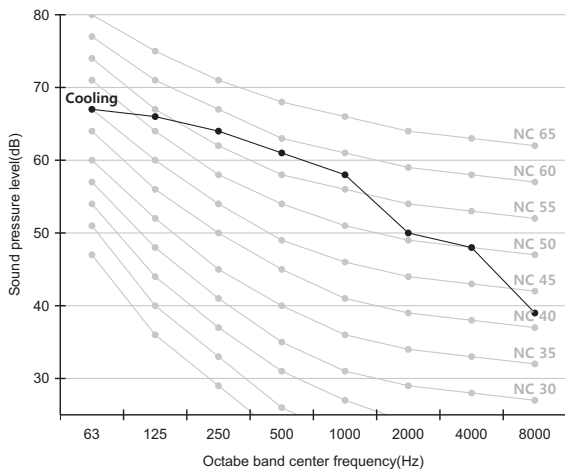

2) AM180FXVAG * /TK

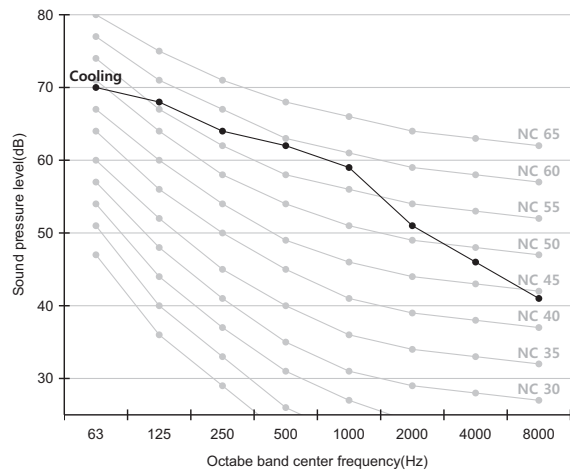

3) AM200FXVAG * /TK

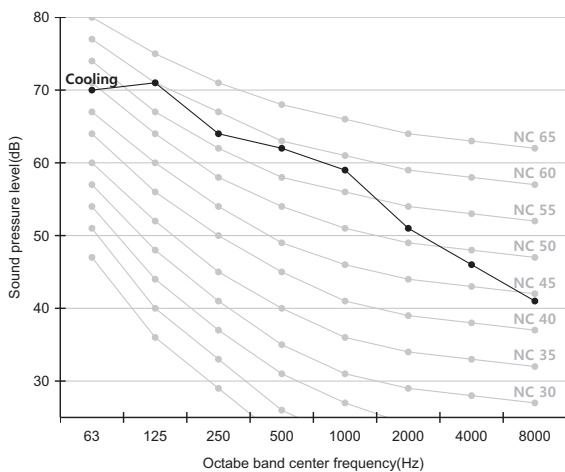

4) AM220FXVAG * /TK

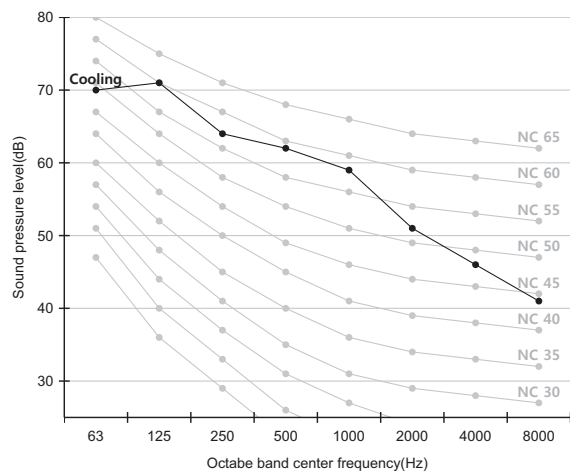

6 Sound pressure level

Outdoor

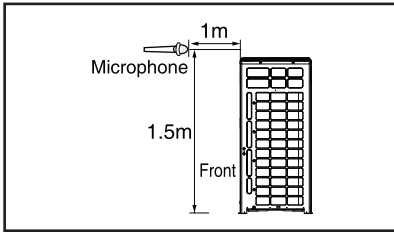

Unit: dB(A)

Model	Pressure
AM240HXVAGH/TK	67.0
AM260HXVAGH/TK	67.0

Note

Measuring place: Anechoic chamber (conversion value)

These operation values were obtained in an anechoic room. Sound pressure level will vary depending on a factors such as the construction of the particular room where the equipment is installed.

Operation sound level may differ depending on operation and ambient conditions.

NC curve

1) AM240HXVAGH/TK

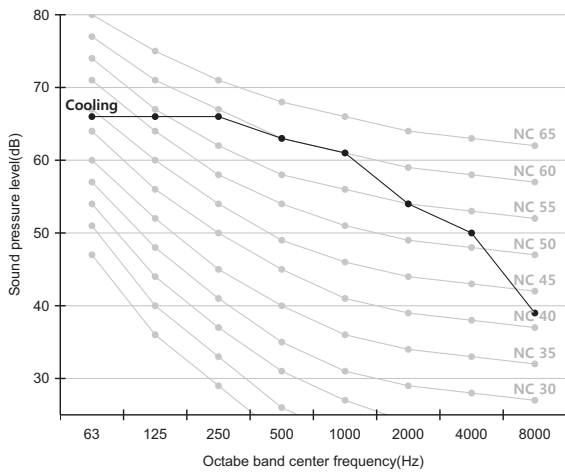

2) AM260HXVAGH/TK

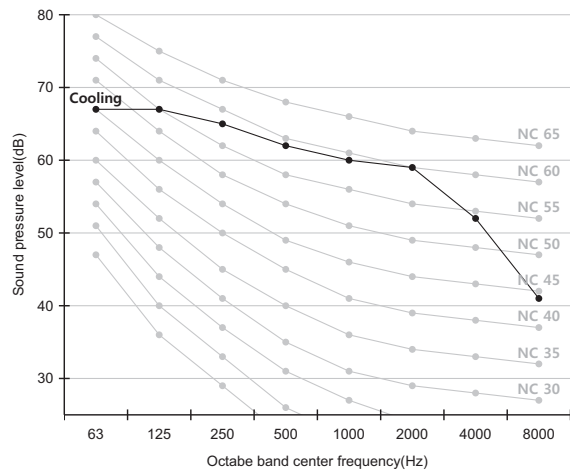

7 Sound power level

Outdoor

Note

dBA = A-weighted sound power level.
Reference power : 1pW.
Measured according to ISO 3741.

Unit: dB(A)

Model	Power
AM080FXVAG * /TK	77.0
AM100FXVAG * /TK	79.0
AM120FXVAG * /TK	81.0
AM140FXVAG * /TK	81.0

1)AM080FXVAG * /TK

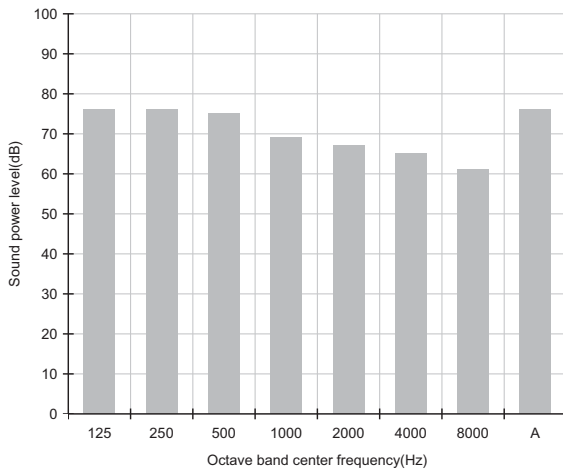

2)AM100FXVAG * /TK

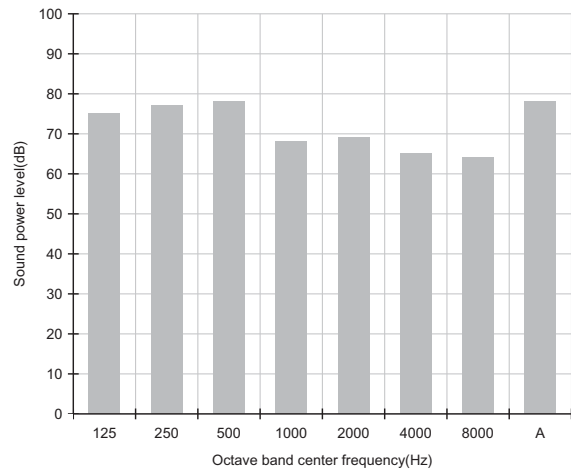

3)AM120FXVAG * /TK

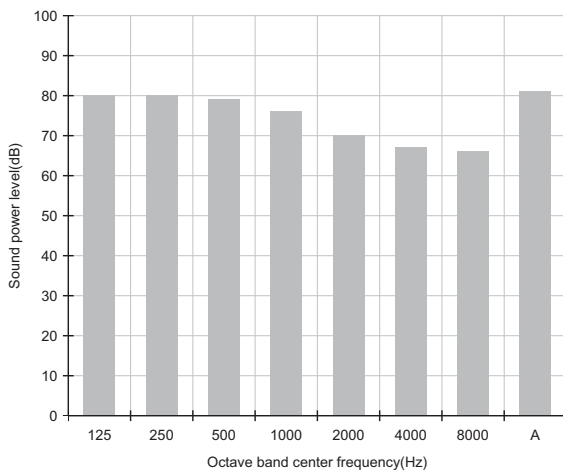

4)AM140FXVAG * /TK

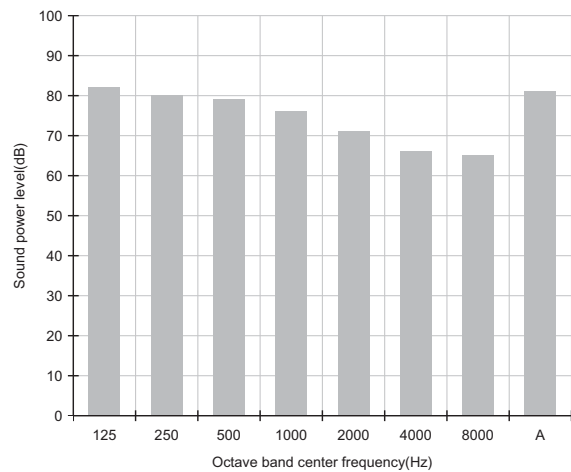

7 Sound power level

Outdoor

Note

dBA = A-weighted sound power level.
Reference power : 1pW.
Measured according to ISO 3741.

Unit: dB(A)

Model	Power
AM160FXVAG * /TK	83.0
AM180FXVAG * /TK	86.0
AM200FXVAG * /TK	87.0
AM220FXVAG * /TK	89.0

1)AM160FXVAG * /TK

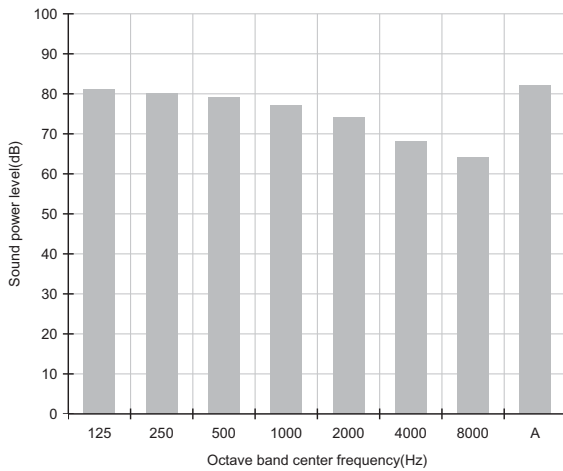

2)AM180FXVAG * /TK

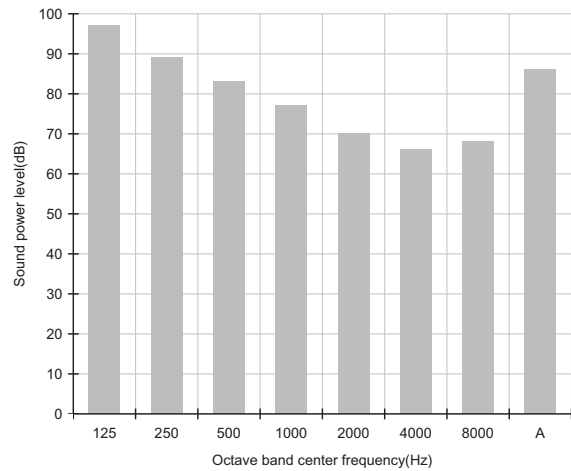

3)AM200FXVAG * /TK

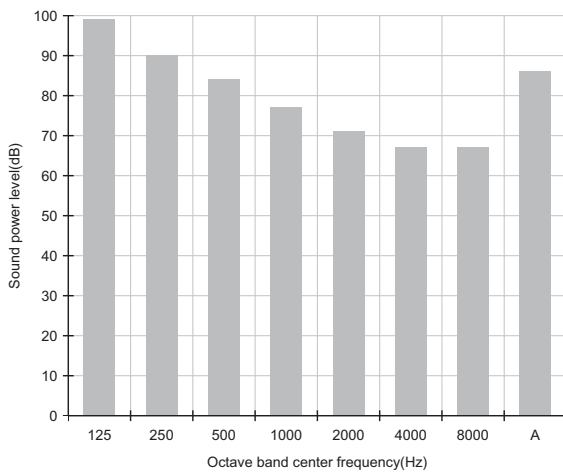

4)AM220FXVAG * /TK

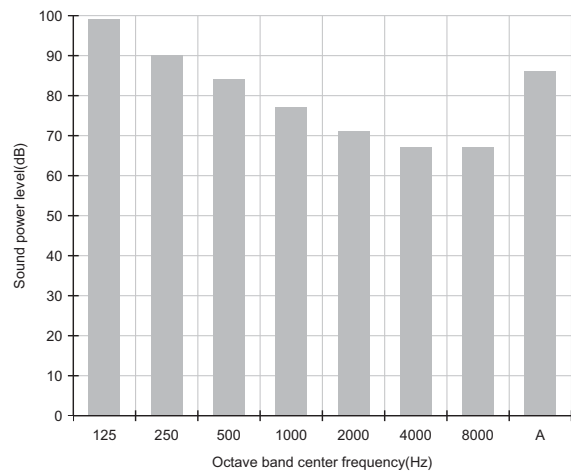

7 Sound power level

Outdoor

Note

dBA = A-weighted sound power level.
Reference power : 1pW.
Measured according to ISO 3741.

Unit: dB(A)

Model	Power
AM240HXVAGH/TK	91.0
AM260HXVAGH/TK	91.0

1)AM240HXVAGH/TK

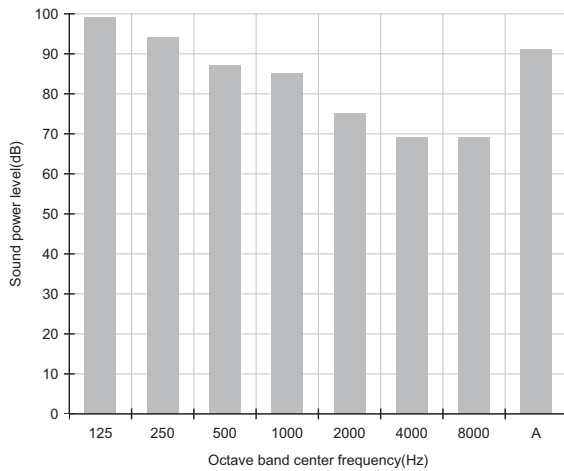

2)AM260HXVAGH/TK

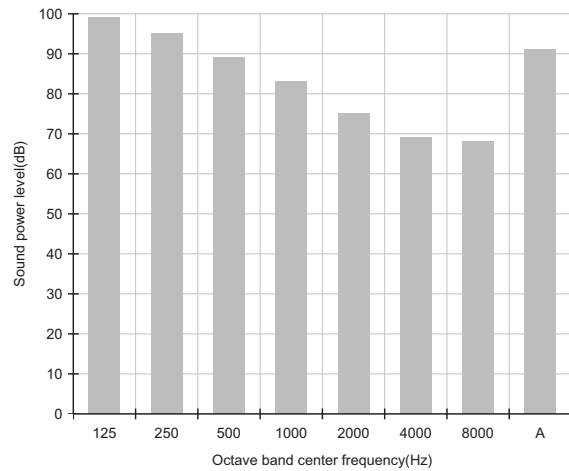

8 Cycle diagram

Heat Pump

AM080FXVAGH/TK, AM100FXVAGH/TK, AM120FXVAGH/TK

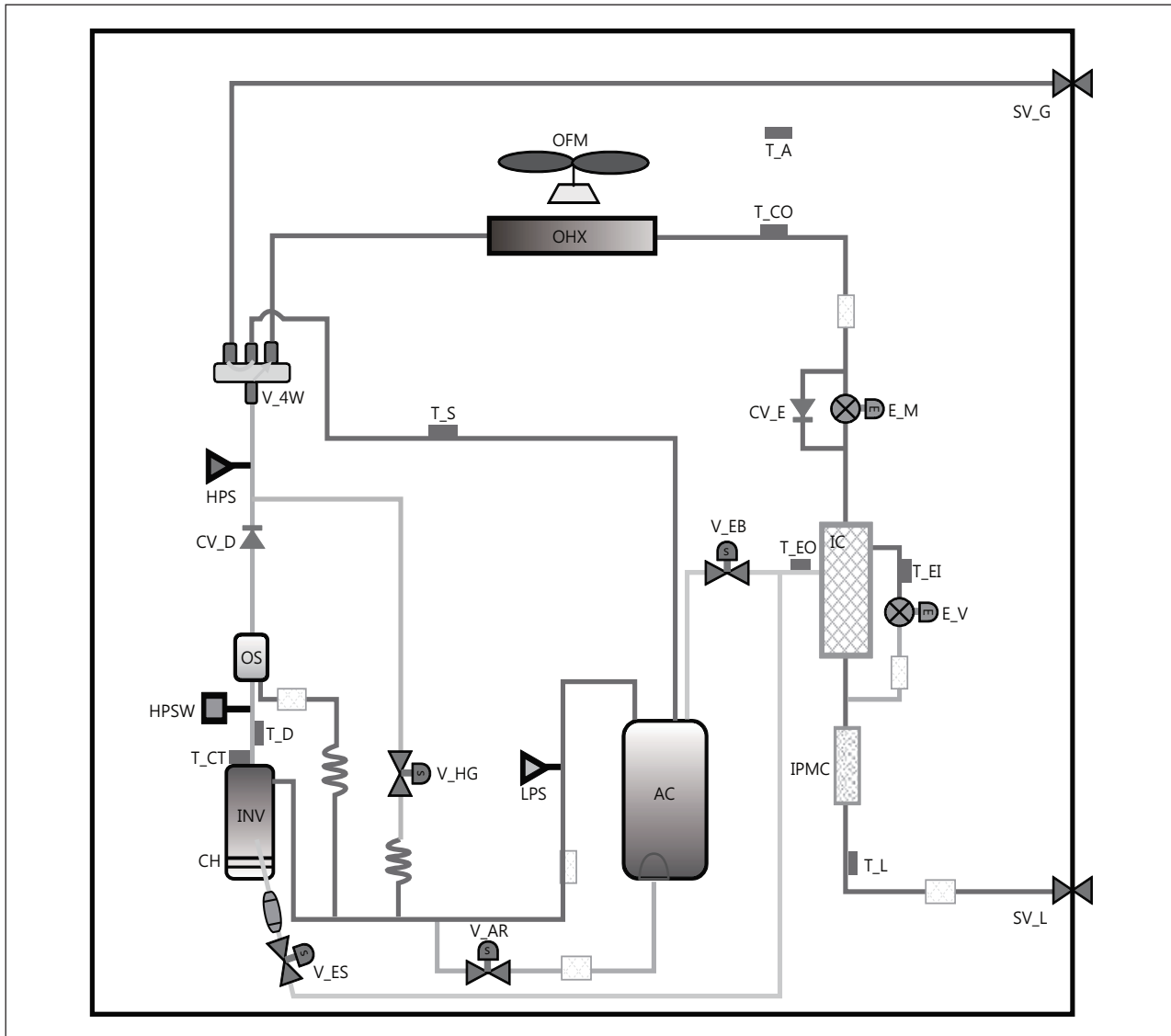

Classification	Description
INV	Inverter Compressor
OFM	Outdoor Fan Motor
OHX	Outdoor Heat Exchanger
AC	Accumulator
OS	Oil Separator
IC	Intercooler
IPMC	IPM Cooler
CH	Crank Case Heater
HPS	High Pressure Sensor
LPS	Low Pressure Sensor
HPSW	High Pressure Switch
E_M	Main EEV
E_EV	EVI EEV
V_ES	EVI Solenoid Valve
V_EB	EVI Bypass Valve

Classification	Description
V_HG	Hot Gas Bypass Valve
V_4W	4way Valve
V_AR	Accumulator Oil Return Valve
CV_E	EEV Bypass Check Valve
CV_D	Discharge Check Valve
T_D	Discharge Temperature Sensor
T_S	Suction Temperature Sensor
T_CO	Condenser Out Temperature Sensor
T_EI	EVI In Temperature Sensor
T_EO	EVI Out Temperature Sensor
T_L	Liquid Tube Temperature Sensor
T_CT	Compressor Top Temperature Sensor
T_A	Ambient Temperature Sensor
SV_G	Gas Pipe Service Valve
SV_L	Liquid Pipe Service Valve

8 Cycle diagram

Heat Pump

AM140FXVAGH/TK

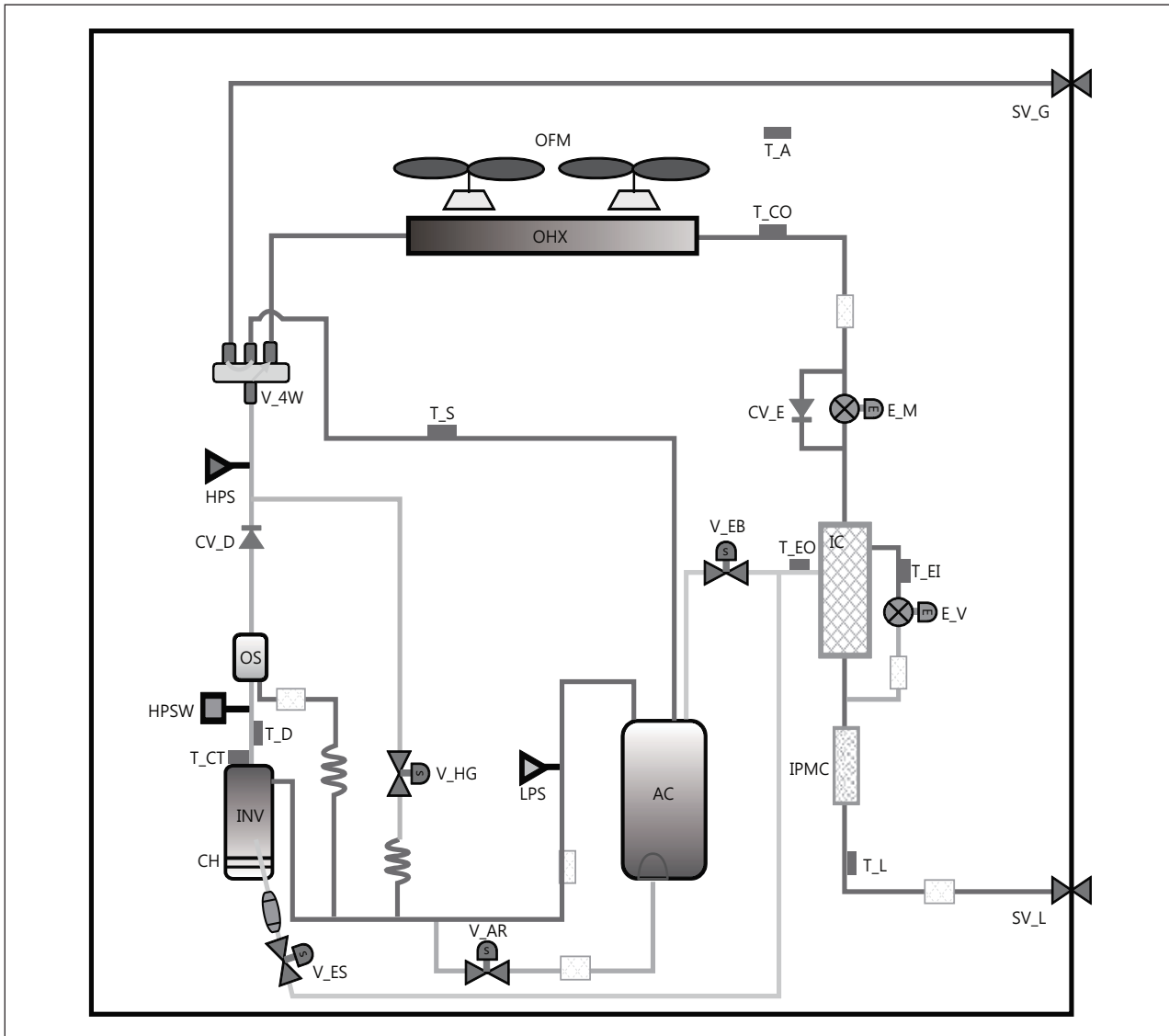

Classification	Description
INV	Inverter Compressor
OFM	Outdoor Fan Motor
OHX	Outdoor Heat Exchanger
AC	Accumulator
OS	Oil Separator
IC	Intercooler
IPMC	IPM Cooler
CH	Crank Case Heater
HPS	High Pressure Sensor
LPS	Low Pressure Sensor
HPSW	High Pressure Switch
E_M	Main EEV
E_EV	EVI EEV
V_ES	EVI Solenoid Valve
V_EB	EVI Bypass Valve

Classification	Description
V_HG	Hot Gas Bypass Valve
V_4W	4way Valve
V_AR	Accumulator Oil Return Valve
CV_E	EEV Bypass Check Valve
CV_D	Discharge Check Valve
T_D	Discharge Temperature Sensor
T_S	Suction Temperature Sensor
T_CO	Condenser Out Temperature Sensor
T_EI	EVI In Temperature Sensor
T_EO	EVI Out Temperature Sensor
T_L	Liquid Tube Temperature Sensor
T_CT	Compressor Top Temperature Sensor
T_A	Ambient Temperature Sensor
SV_G	Gas Pipe Service Valve
SV_L	Liquid Pipe Service Valve

8 Cycle diagram

Heat Pump

AM160FXVAGH/TK, AM180FXVAGH/TK, AM200FXVAGH/TK, AM220FXVAGH/TK

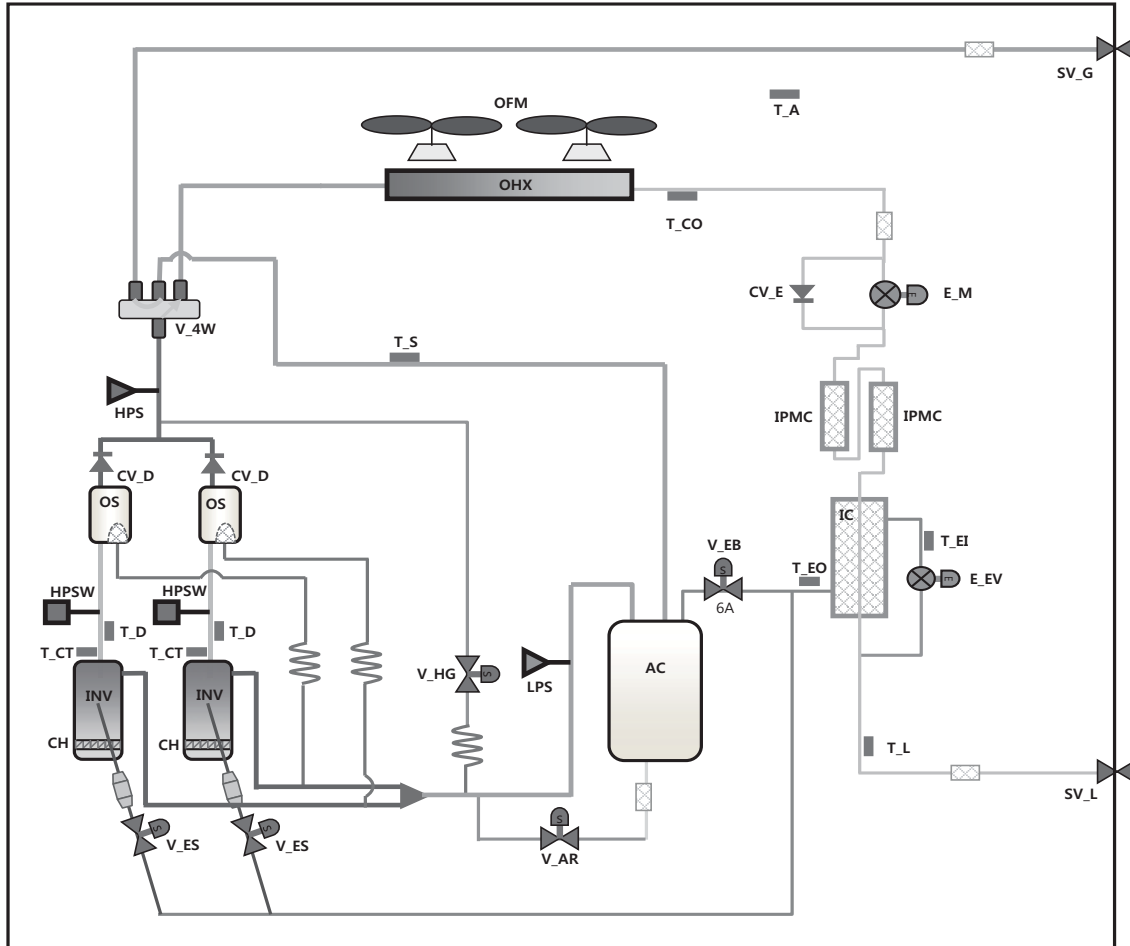

Classification	Description
INV	Inverter Compressor
OFM	Outdoor Fan Motor
OHX	Outdoor Heat Exchanger
AC	Accumulator
OS	Oil Separator
IC	Intercooler
IPMC	IPM Cooler
CH	Crank Case Heater
HPS	High Pressure Sensor
LPS	Low Pressure Sensor
HPSW	High Pressure Switch
E_M	Main EEV
E_EV	EVI EEV
V_ES	EVI Solenoid Valve
V_EB	EVI Bypass Valve

Classification	Description
V_HG	Hot Gas Bypass Valve
V_4W	4way Valve
V_AR	Accumulator Oil Return Valve
CV_E	EEV Bypass Check Valve
CV_D	Discharge Check Valve
T_D	Discharge Temperature Sensor
T_S	Suction Temperature Sensor
T_CO	Condenser Out Temperature Sensor
T_EI	EVI In Temperature Sensor
T_EO	EVI Out Temperature Sensor
T_L	Liquid Tube Temperature Sensor
T_CT	Compressor Top Temperature Sensor
T_A	Ambient Temperature Sensor
SV_G	Gas Pipe Service Valve
SV_L	Liquid Pipe Service Valve

8 Cycle diagram

Heat Pump

AM240HXVAGH/TK, AM260HXVAGH/TK

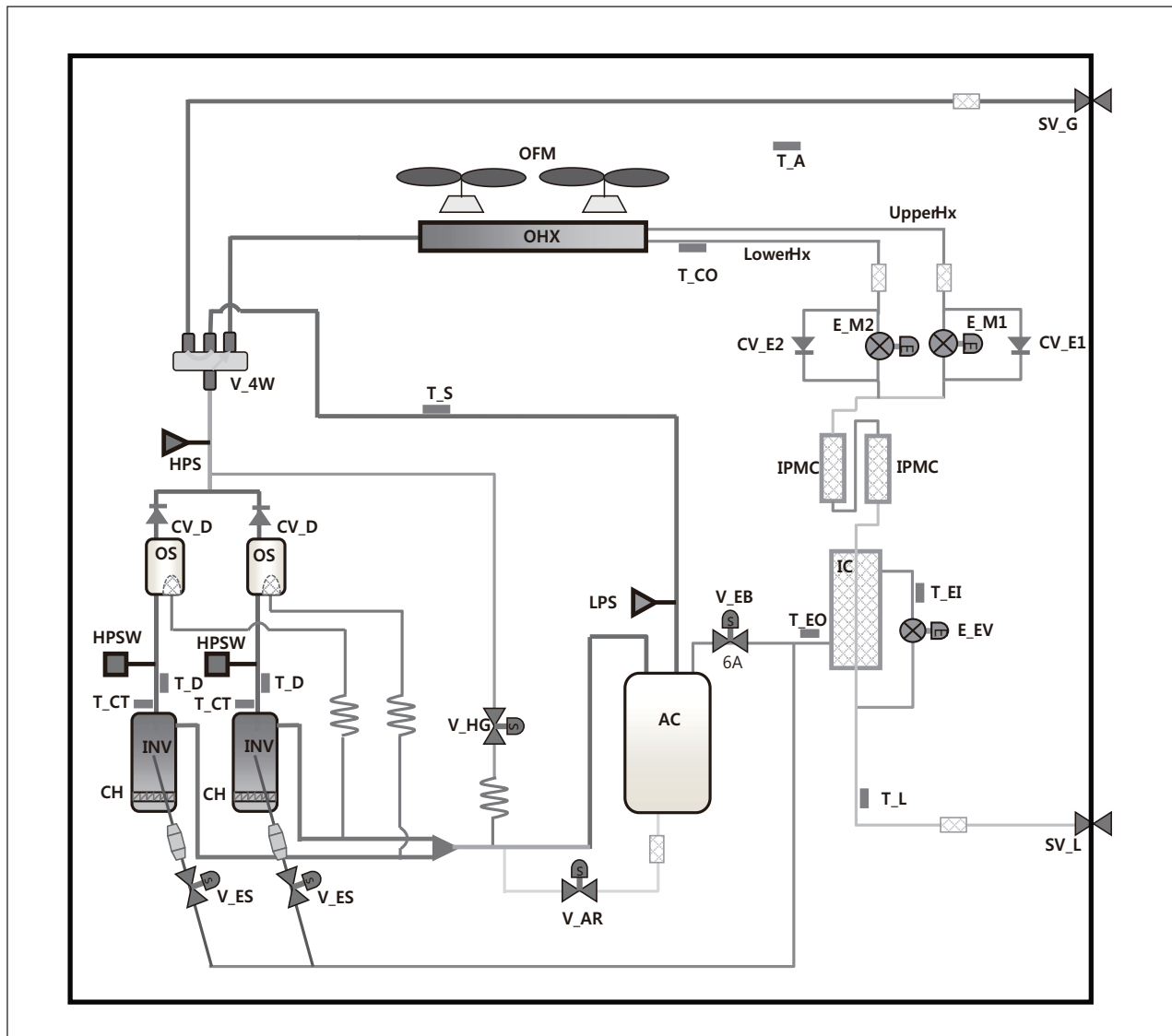

Classification	Description
INV	Inverter Compressor
OFM	Outdoor Fan Motor
OHX	Outdoor Heat Exchanger
AC	Accumulator
OS	Oil Separator
IC	Intercooler
IPMC	IPM Cooler
CH	Crank Case Heater
HPS	High Pressure Sensor
LPS	Low Pressure Sensor
HPSW	High Pressure Switch
E_M	Main EEV
E_EV	EVI EEV
V_ES	EVI Solenoid Valve
V_EB	EVI Bypass Valve

Classification	Description
V_HG	Hot Gas Bypass Valve
V_4W	4way Valve
V_AR	Accumulator Oil Return Valve
CV_E	EEV Bypass Check Valve
CV_D	Discharge Check Valve
T_D	Discharge Temperature Sensor
T_S	Suction Temperature Sensor
T_CO	Condenser Out Temperature Sensor
T_EI	EVI In Temperature Sensor
T_EO	EVI Out Temperature Sensor
T_L	Liquid Tube Temperature Sensor
T_CT	Compressor Top Temperature Sensor
T_A	Ambient Temperature Sensor
SV_G	Gas Pipe Service Valve
SV_L	Liquid Pipe Service Valve

8 Cycle diagram

Heat Recovery

AM080HXVAGR/TK, AM100HXVAGR/TK, AM120HXVAGR/TK

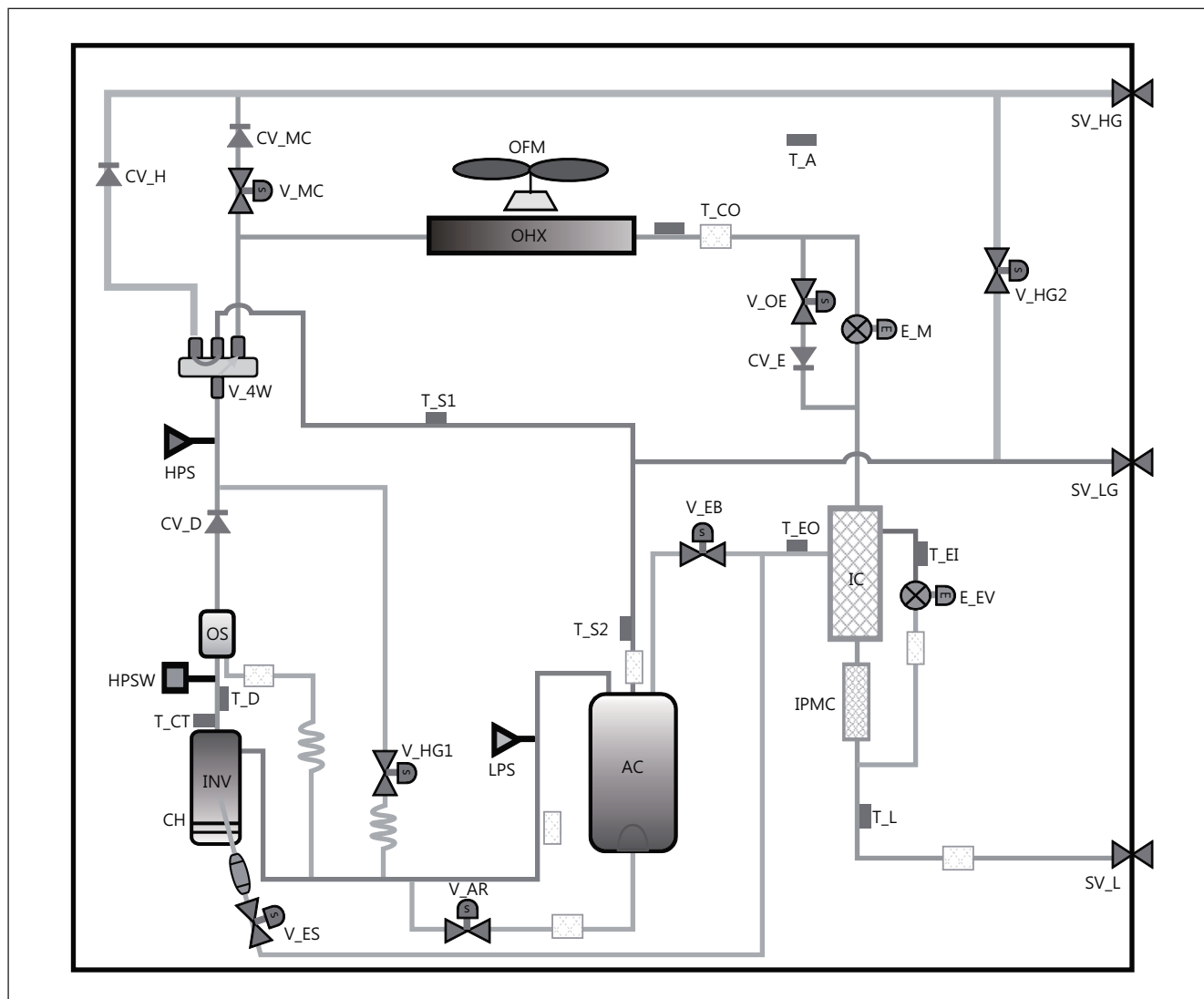

Classification	Description
INV	Inverter Compressor
OFM	Outdoor Fan Motor
OHX	Outdoor Heat Exchanger
AC	Accumulator
OS	Oil Separator
IC	Intercooler
IPMC	IPM Cooler
CH	Crank Case Heater
HPS	High Pressure Sensor
LPS	Low Pressure Sensor
HPSW	High Pressure Switch
E_M	Main EEV
E_EV	EVI EEV
V_MC	Main Cooling Valve
V_ES	EVI Solenoid Valve
V_EB	EVI Bypass Valve
V_HG1	Hot Gas Bypass Valve 1
V_HG2	Hot Gas Bypass Valve 2

Classification	Description
V_4W	4Way Valve
V_AR	Accumulator Oil Return Valve
V_OE	Outdoor EEV Valve
CV_E	EEV Bypass Check Valve
CV_D	Discharge Check Valve
CV_H	HR Check valve
CV_MC	Main Cooling Check Valve
T_D	Discharge Temp. Sensor
T_S1	Suction Temp. Sensor 1
T_S2	Suction Temp. Sensor 2
T_CO	Cond Out Temp. Sensor
T_EI	EVI In Temp. Sensor
T_EO	EVI Out Temp. Sensor
T_L	Liquid Tube Temp. Sensor
T_CT	Comp. Top Temp. Sensor
T_A	Ambient Temp. Sensor
SV_HG	Low Gas Pipe Service Valve
SV_LG	Ambient Temp. Sensor
SV_L	Liquid Pipe Service Valve

8 Cycle diagram

Heat Recovery

AM140HXVAGR/TK

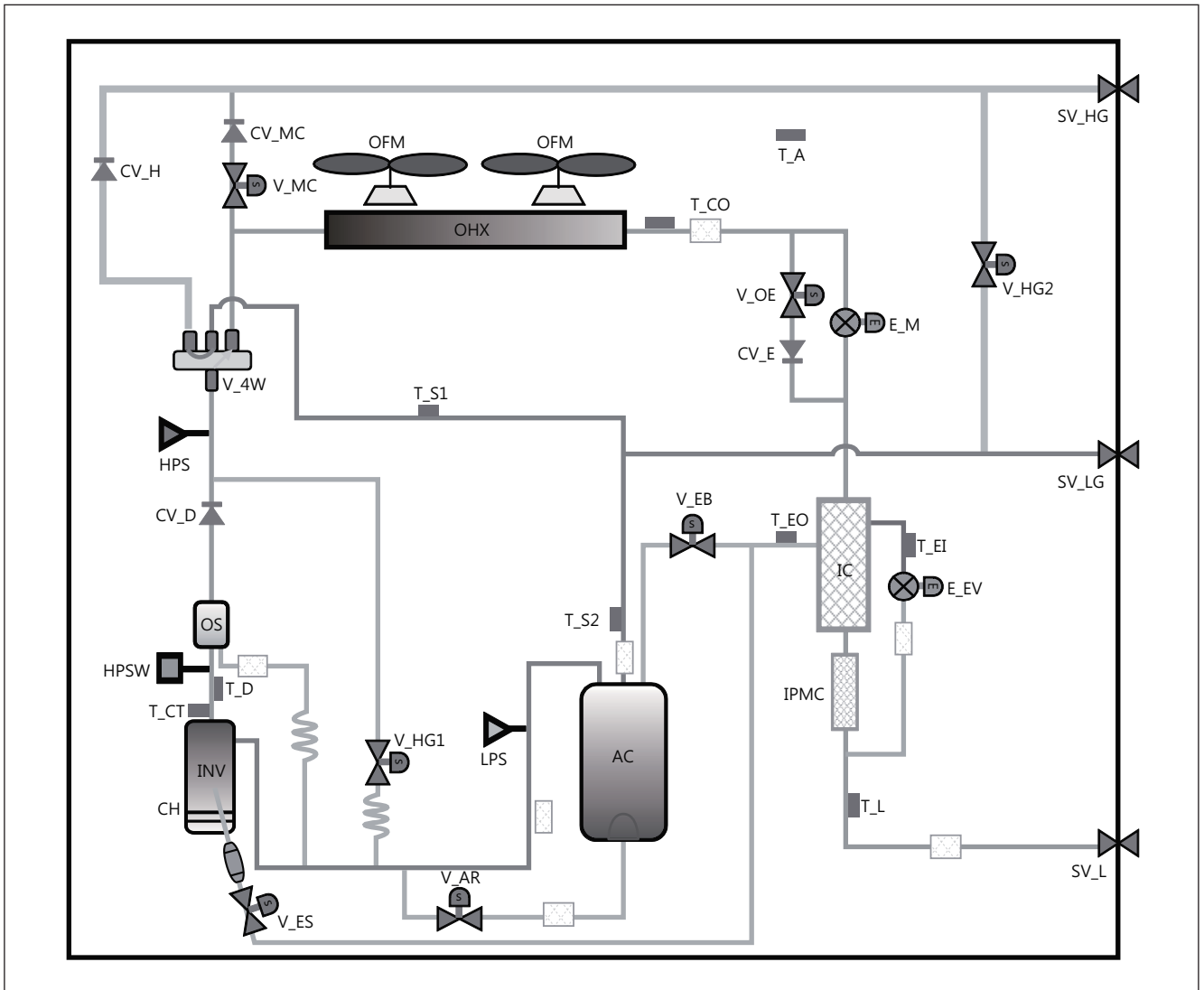

Classification	Description
INV	Inverter Compressor
OFM	Outdoor Fan Motor
OHX	Outdoor Heat Exchanger
AC	Accumulator
OS	Oil Separator
IC	Intercooler
IPMC	IPM Cooler
CH	Crank Case Heater
HPS	High Pressure Sensor
LPS	Low Pressure Sensor
HPSW	High Pressure Switch
E_M	Main EEV
E_EV	EVI EEV
V_MC	Main Cooling Valve
V_ES	EVI Solenoid Valve
V_EB	EVI Bypass Valve
V_HG1	Hot Gas Bypass Valve 1
V_HG2	Hot Gas Bypass Valve 2

Classification	Description
V_4W	4Way Valve
V_AR	Accumulator Oil Return Valve
V_OE	Outdoor EEV Valve
CV_E	EEV Bypass Check Valve
CV_D	Discharge Check Valve
CV_H	HR Check valve
CV_MC	Main Cooling Check Valve
T_D	Discharge Temp. Sensor
T_S1	Suction Temp. Sensor 1
T_S2	Suction Temp. Sensor 2
T_CO	Cond Out Temp. Sensor
T_EI	EVI In Temp. Sensor
T_EO	EVI Out Temp. Sensor
T_L	Liquid Tube Temp. Sensor
T_CT	Comp. Top Temp. Sensor
T_A	Ambient Temp. Sensor
SV_HG	Low Gas Pipe Service Valve
SV_LG	Ambient Temp. Sensor
SV_L	Liquid Pipe Service Valve

8 Cycle diagram

Heat Recovery

AM160HXVAGR/TK, AM180HXVAGR/TK, AM200HXVAGR/TK, AM220HXVAGR/TK

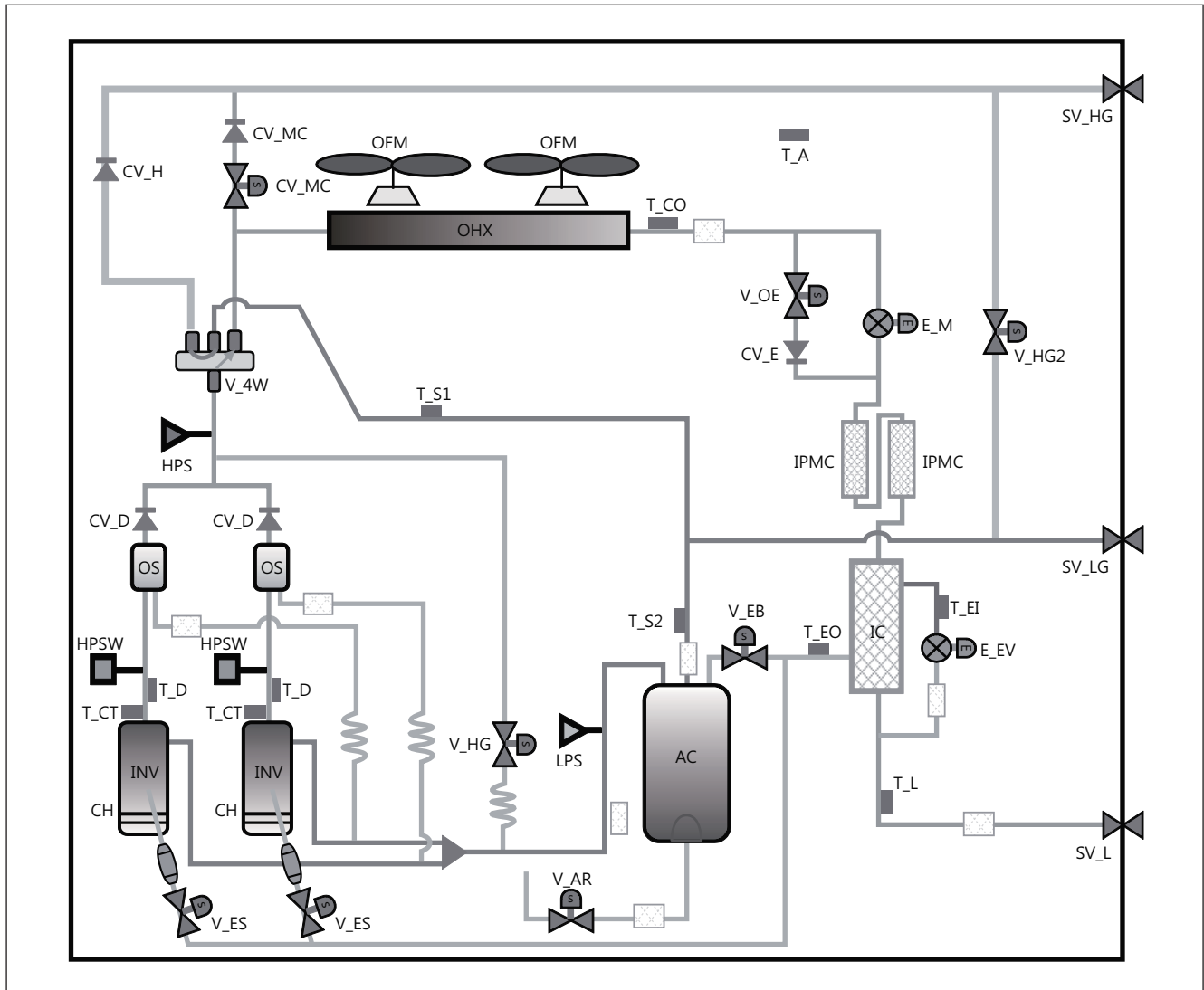

Classification	Description
INV	Inverter Compressor
OFM	Outdoor Fan Motor
OHX	Outdoor Heat Exchanger
AC	Accumulator
OS	Oil Separator
IC	Intercooler
IPMC	IPM Cooler
CH	Crank Case Heater
HPS	High Pressure Sensor
LPS	Low Pressure Sensor
HPSW	High Pressure Switch
E_M	Main EEV
E_EV	EVI EEV
V_MC	Main Cooling Valve
V_ES	EVI Solenoid Valve
V_EB	EVI Bypass Valve
V_HG1	Hot Gas Bypass Valve 1
V_HG2	Hot Gas Bypass Valve 2

Classification	Description
V_4W	4Way Valve
V_AR	Accumulator Oil Return Valve
V_OE	Outdoor EEV Valve
CV_E	EEV Bypass Check Valve
CV_D	Discharge Check Valve
CV_H	HR Check valve
CV_MC	Main Cooling Check Valve
T_D	Discharge Temp. Sensor
T_S1	Suction Temp. Sensor 1
T_S2	Suction Temp. Sensor 2
T_CO	Cond Out Temp. Sensor
T_EI	EVI In Temp. Sensor
T_EO	EVI Out Temp. Sensor
T_L	Liquid Tube Temp. Sensor
T_CT	Comp. Top Temp. Sensor
T_A	Ambient Temp. Sensor
SV_HG	Low Gas Pipe Service Valve
SV_LG	Ambient Temp. Sensor
SV_L	Liquid Pipe Service Valve

9 Installation

1. Space requirement for installation

1) Single installation

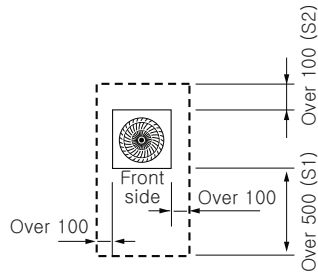

<Case 1>

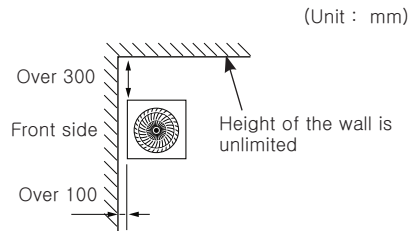

<Case 2>

2) Module installation

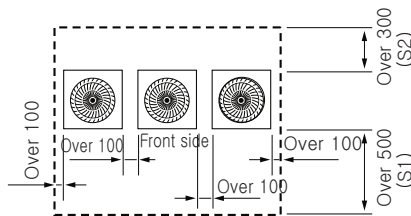

<Case 1>

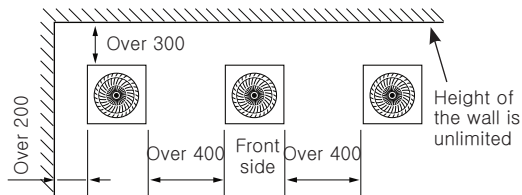

<Case 2>

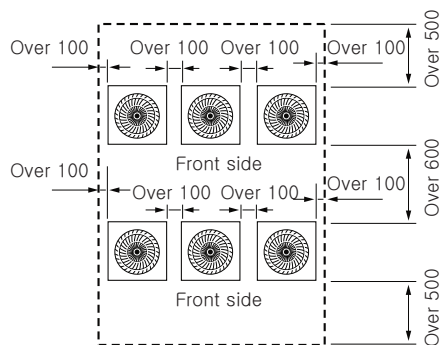

<Case 3>

► For <Case 1> or <Case 3>

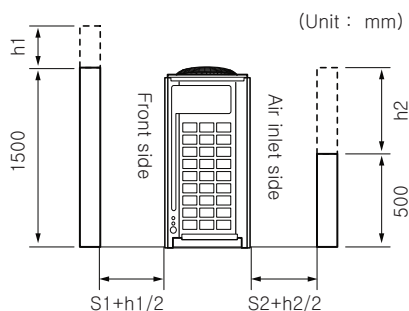

- Height of the wall on the front side should not be higher than 1500mm.
- Height of the wall on the air inlet side should not be higher than 500mm.
- Height of the wall on the side is not limited.
- If the height of the wall exceeds by certain value (h_1 , h_2), additional clearance $[(h_1)/2, (h_2)/2]$: Half of the exceeded distance] should be added to the service space (S_1 , S_2)

✓ Note

- ◆ Space requirement was decided based on following conditions: Cooling mode, outdoor temperature of 35 °C. Larger space is required if the outdoor temperature is higher than 35 °C or if the place is heated easily by quantity of solar radiation.
- ◆ When you secure installation space, consider path for people and the direction of the wind.
- ◆ Secure installation space as shown in the below illustration, considering ventilation and the service space.
- ◆ If the installation space is narrow, installer or other worker may get injured during work and may also cause problem to the product.
- ◆ If you install multiple number of outdoor units in one space, make sure to secure enough ventilation space if there's any walls around the product that may disturb the air flow. If enough ventilation space is not secured, product may malfunction.
- ◆ You may install the outdoor units with 20mm of space between the product, but product's performance may decrease depending on the installation environment.

9 Installation

2. Base construction and installation of the outdoor unit

- ◆ Make sure that the height of the base ground is 200mm or higher to protect the outdoor unit from rain water or other external conditions. Also, install a draining pit around the base ground and connect the drain pipe to the drainage.
- ◆ Considering the vibration and weight of the outdoor unit, strength of the base ground must be strong to prevent noise and the top surface of it should be flat.
- ◆ Base ground should be 1.5 times larger than the bottom of the outdoor unit.
- ◆ Outdoor unit must be fixed firmly so that it can withstand the wind speed of 30m/s. If you cannot fix the outdoor unit on the base ground, fix it by side or use extra structure.
- ◆ In heating operation, defrost water may form so you must really care about the drainage and waterproofing the floor. To prevent defrost water from stagnating or freezing, construct a drainage with over 1/50 slope. (Ice may form on the floor in winter time.)
- ◆ It is necessary to add wire mesh or steel bar during concrete construction for the base ground to prevent damages or cracks.
- ◆ When installing multiple outdoor units at the same place, construct a H beam or an anti-vibration frame on the base ground to install the outdoor unit.
- ◆ After installing a H beam or an anti-vibration frame, apply corrosion protection and other necessary coating.
- ◆ When concrete construction for outdoor unit installation is completed, install an anti-vibration pad (t=20mm or more) or an anti-vibration frame to prevent vibration of the outdoor unit from transferring to the base ground.
- ◆ Place the outdoor unit on a H beam or an anti-vibration frame and fix it with the bolt, nut and washer. (The bearing force has to be over 3.5kN)

1) Base ground construction

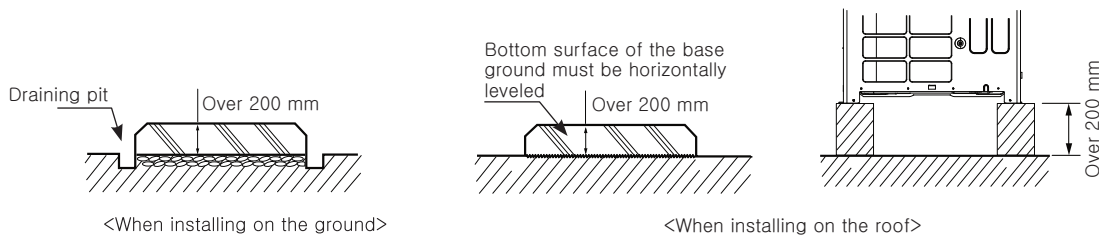

2) Outdoor unit installation

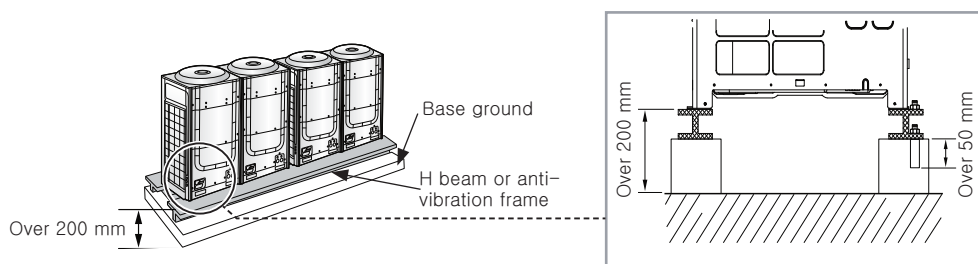

3) Outdoor unit base mount and anchor bolt position

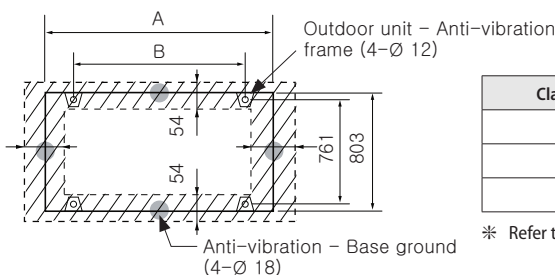

(Unit : mm)

Classification	Small type	Large type
Models	AM080/100/120* <i>XVAG</i> *	AM140/160/180/200/220/240/260* <i>XVAG</i> *
A	880	1,295
B	740	1,150

* Refer to the blueprints in technical data book to make a holes for connecting the anti-vibration pad

9 Installation

4) Examples of draining work

- ▶ Construct the drainage ditch with reinforced concretes and make sure that water-proofing work is done.
- ▶ For smooth draining of defrost water, make sure to apply 1/50 slope.
- ▶ Construct a drainage around the outdoor unit to prevent the defrost water (from the outdoor unit) from stagnating, overflowing or freezing near the installation space.
- ▶ When the outdoor unit is installed on the roof, check the strength and waterproof status of the roof.

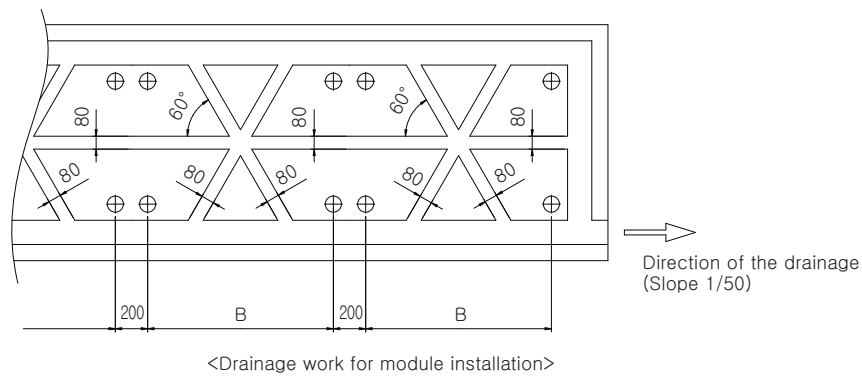
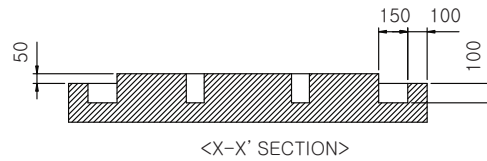
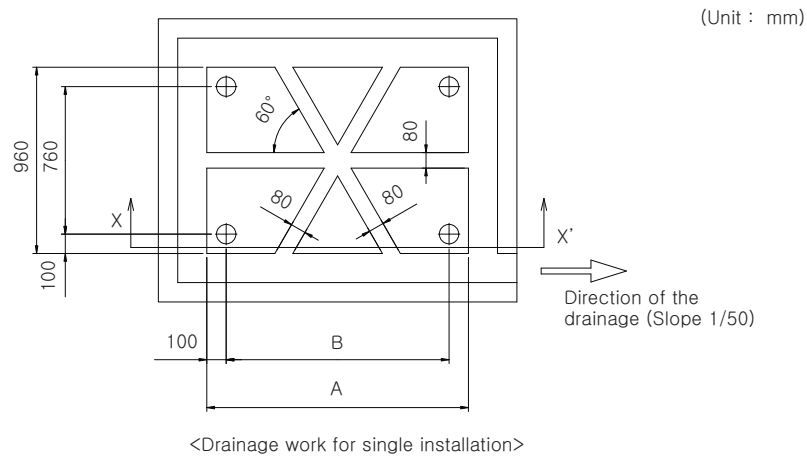

(Unit : mm)

Classification	Small type	Large type
Models	AM080/100/120*XVAG*	AM140/160/180/200/220/240/260*XVAG*
A	940	1,350
B	740	1,150

9 Installation

3. Refrigerant pipe installation

1) Refrigerant pipe work

- ▶ The length of refrigerant pipe should be as short as possible and the height difference between an indoor and outdoor unit should be minimized.
- ▶ Piping work must be done within allowable piping length, height difference, and the allowable length after branching.
- ▶ The pressure of the R-410A is high. Use only certified refrigerant pipe and follow the installation method.
- ▶ After installing the pipes, calculate the total length of the pipe to check if additional refrigerant is needed. When you need to charge the additional refrigerant, make sure to use R-410A refrigerant.
- ▶ Use clean refrigerant pipe and there shouldn't be any harmful ion, oxide, dust, iron content or moisture inside pipe.
- ▶ Use tools and accessories that fit on R-410A only

Tool	Installation process/purpose	Compatibility with conventional tool	
Pipe cutter	Refrigerant pipe installation	Pipe cutting	Compatible
Flaring tool		Pipe flaring	
Refrigerant machine oil		Apply refrigerant oil on flared part	Exclusive ether oil, ester oil, alkali benzene oil or synthetic oil
Torque wrench		Connect flare nut with pipe	Compatible
Pipe bender		Pipe bending	
Nitrogen gas	Air tightness test	Prevent oxidation within the pipe	Compatible
Welder		Pipe welding	
Manifold gage	Air tightness test ~ additional refrigerant charging	Vacuuming, charging refrigerant and checking operation	Need exclusive one to prevent mixture of R-22 refrigerant oil use and also the measurement is not available due to high pressure
Refrigerant charging hose			Need exclusive one since there is risk of refrigerant leakage or inflow of impurities
Vacuum pump	Pipe drying		Compatible (Use products which contain the check valve to prevent the oil from flowing backward into the outdoor unit.) Use the one that can be vacuumed up to -100.7kpa(5Torr).
Scale for refrigerant charging			Compatible
Gas leak detector		Gas leak test	Need exclusive one (Ones used for R-134a is compatible)
Flare nut	Must use the flare nut equipped with the product . Refrigerant leakage may occur when the conventional flare nut for R-22 is used		

2) Selecting refrigerant pipe

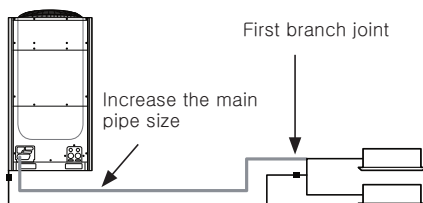

- ▶ Install the refrigerant pipe according to main pipe size of each outdoor unit capacity.
- ▶ When the pipe length (including elbow) between an outdoor unit and the farthest indoor unit exceeds 90m, you must increase the size of the pipe (main pipe) by one grade which connects between the outdoor unit to the first branch joint.
- ▶ For H/R model, When the pipe length (including elbow) between an outdoor unit and the farthest indoor unit exceeds 90m, you must increase the size of the liquid pipe by one grade among the pipes(main pipe) which connects between the outdoor unit to the first branch joint.

9 Installation

(1) Heat Pump

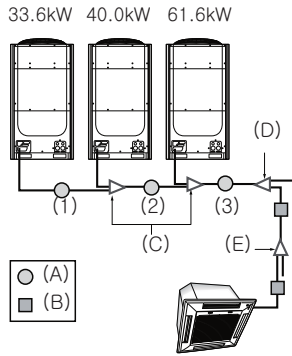

Ex.) 135.2 kW

Capacity (kW)	No.	Pipe size (mm)	
		Liquid pipe	Gas pipe
33.6kW	(1)	Ø 12.70	Ø 28.58
73.6kW	(2)	Ø 19.05	Ø 34.92
135.2kW	(3)	Ø 19.05	Ø 41.28

① Size of the pipe connected to the outdoor unit (A)

Select the size of the pipe according to the below table.

Outdoor unit capacity (kW)	*Maximum pipe length within 90m (Main pipe diameter)		*Maximum pipe length over 90m (Main pipe diameter)	
	Liquid pipe (mm)	gas pipe (mm)	Liquid pipe (mm)	gas pipe (mm)
22.4 kW	Ø 9.52	Ø 19.05	Ø 12.70	Ø 22.22
28.0 kW		Ø 22.22		Ø 25.40 ^{note1)}
33.6 kW	Ø 12.70	Ø 28.58	Ø 15.88	Ø 28.58
40.0 kW				Ø 31.75 ^{note2)}
45.0 kW				
50.4 kW	Ø 15.88	Ø 34.92	Ø 19.05	Ø 38.10 ^{note3)}
56.0 kW				
61.6 kW	Ø 19.05	Ø 41.28	Ø 22.22	Ø 41.28
67.2 kW				Ø 53.98
72.8 kW ~ 84.0 kW				
89.6 kW ~ 95.2 kW	Ø 22.22	Ø 53.98	Ø 25.40 ^{note1)}	Ø 53.98
101.6 kW				
106.6 kW ~ 135.2 kW	Ø 22.22	Ø 53.98	Ø 25.40 ^{note1)}	Ø 53.98
140.2 kW ~ 168.2 kW				
173.6 kW ~ 224.8 kW	Ø 22.22	Ø 53.98	Ø 25.40 ^{note1)}	Ø 53.98

*Maximum pipe length : The pipe length between an outdoor unit and the farthest indoor unit

② Size of the pipe between branch joints (B)

Select the pipe size according to the sum of indoor unit capacity which will be connected after the branch.

Indoor unit capacity (kW)	Branch pipe length within 45m		Branch pipe length between 45~90m	
	Liquid pipe (mm)	Gas pipe (mm)	Liquid pipe (mm)	Gas pipe (mm)
15.0 kW and below	Ø 9.52	Ø 15.88	Ø 12.70	Ø 19.05
Over 15.0 kW ~ 22.4 kW and below		Ø 19.05		Ø 22.22
Over 22.4 kW ~ 28.1 kW and below		Ø 22.22		Ø 25.40 ^{note1)}
Over 28.1 kW ~ 40.0 kW and below	Ø 12.70	Ø 28.58	Ø 15.88	Ø 28.58
Over 40.0 kW ~ 45.0 kW and below				Ø 31.75 ^{note2)}
Over 45.0 kW ~ 63.3 kW and below	Ø 15.88	Ø 34.92	Ø 19.05	Ø 38.10 ^{note3)}
Over 63.3 kW ~ 70.3 kW and below				
Over 70.3 kW ~ 98.4 kW and below	Ø 19.05	Ø 41.28	Ø 22.22	Ø 41.28
Over 98.4 kW ~ 135.2 kW and below				
Over 135.2 kW ~ 169.0 kW and below	Ø 22.22	Ø 53.98	Ø 25.40 ^{note1)}	Ø 53.98
Over 169.0 kW				

Note1) If Ø 25.40 pipe is not available on site, use Ø 28.58 pipe.

Note2) If Ø 31.75 pipe is not available on site, use Ø 34.92 pipe.

Note3) If Ø 38.10 pipe is not available on site, use Ø 41.28 pipe.

9 Installation

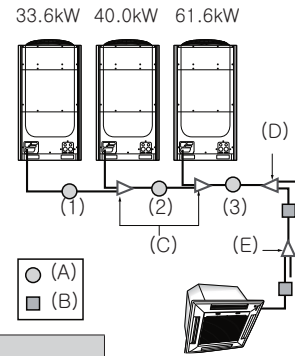

- ③ Size of the pipe between the branch joint and the indoor unit
Make a selection according to outdoor unit capacity.

Indoor unit capacity (kW)	Pipe size (O.D. mm)	
	Liquid pipe	Gas pipe
6.0 kW and below	Ø 6.35	Ø 12.70
7.1 kW ~ 16.0 kW and below	Ø 9.52	Ø 15.88
20.0 kW ~ 23.0 kW and below	Ø 9.52	Ø 19.05
Over 23.0 kW	Ø 9.52	Ø 22.22

- ④ Branch joint

▶ Branch joint between outdoor units (C)

Classification	Model name	Specification (kW)
Y-joint for outdoor unit (C)	MXJ-TA3419M	135.2 kW and below
	MXJ-TA4122M	Over 140.2 kW

▶ First branch joint (D)

Make a selection according to outdoor unit capacity.

Classification	Outdoor unit capacity (kW)	Model name of the branch joint
Y-joint (D)	40.0 kW and below	MXJ-YA2512M
	45.0 kW	MXJ-YA2812M
	50.4 kW ~ 67.2 kW	MXJ-YA2815M
	73.6 kW ~ 95.2 kW	MXJ-YA3419M
	101.6 kW ~ 135.2 kW	MXJ-YA4119M
	140.2 kW and over	MXJ-YA4422M

▶ Branch joint (E)

Select a branch joint according to the sum of indoor unit capacity which will be connected after the branch.

< Y-joint >

Classification	Model name	Specification (kW)
Y-joint (E)	MXJ-YA1509M	15.0 kW and below
	MXJ-YA2512M	Over 15.0 kW ~ 40.0 kW and below
	MXJ-YA2812M	Over 40.0 kW ~ 45.0 kW and below
	MXJ-YA2815M	Over 45.0 kW ~ 70.3 kW and below
	MXJ-YA3419M	Over 70.3 kW ~ 98.4 kW and below
	MXJ-YA4119M	Over 98.4 kW ~ 135.2 kW and below
	MXJ-YA4422M	Over 135.2 kW

< Distribution header >

Classification	Model name	Specification (kW)
Distribution header (E)	MXJ-HA2512M	45.0 kW and below (for 4 rooms)
	MXJ-HA3115M	70.3 kW and below (for 8 rooms)
	MXJ-HA3819M	Over 70.3 kW ~ 135.2 kW and below (for 8 rooms)

9 Installation

(2) Heat Recovery

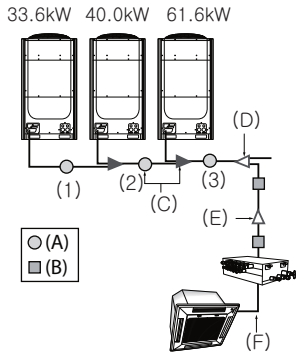

Ex.) 135.2 kW

Capacity	No.	Pipe size (mm)		
		Liquid pipe	Gas pipe	High pressure gas pipe
33.6 kW	(1)	Ø 12.70	Ø 28.58	Ø 19.05
73.6 kW	(2)	Ø 19.05	Ø 34.92	Ø 28.58
135.2 kW	(3)	Ø 19.05	Ø 41.28	Ø 34.92

① Size of the pipe connected to the outdoor unit (A)

Select the size of the pipe according to the below table.

Outdoor unit capacity (kW)	Main pipe length within 90m			Size Up (Main pipe length over 90m)		
	Liquid pipe (mm)	Low pressure gas pipe (mm)	High pressure gas pipe (mm)	Liquid pipe (mm)	Low pressure gas pipe (mm)	High pressure gas pipe (mm)
22.4 kW	Ø 9.52	Ø 19.05	Ø 15.88	Ø 12.70	Ø 19.05	Ø 15.88
28.0 kW		Ø 22.22	Ø 19.05		Ø 22.22	Ø 19.05
33.6 kW	Ø 12.70	Ø 28.58	Ø 22.22	Ø 15.88	Ø 28.58	Ø 22.22
40.0 kW						
45.0 kW						
50.4 kW	Ø 15.88	Ø 28.58	Ø 28.58	Ø 19.05	Ø 28.58	Ø 28.58
56.0 kW						
61.6 kW	Ø 19.05	Ø 34.92	Ø 28.58	Ø 19.05	Ø 34.92	Ø 28.58
67.2 kW						
72.8 kW ~ 84.0 kW						
89.6 kW ~ 95.2 kW	Ø 22.22	Ø 41.28	Ø 34.92	Ø 22.22	Ø 41.28	Ø 34.92
101.6 kW						
106.6 kW ~ 135.2 kW	Ø 22.22	Ø 53.98	Ø 41.28	Ø 25.40	Ø 53.98	Ø 41.28
140.2 kW ~ 168.2 kW						
173.6 kW ~ 224.8 kW	Ø 22.22	Ø 53.98	Ø 41.28	Ø 25.40	Ø 53.98	Ø 41.28

Note1) If Ø 25.40 pipe is not available on site, use Ø 28.58 pipe

※For HR model, only increase the size of the liquid pipe if pipe length exceeds 90m

② Size of the pipe between branch joints (B)

Select the pipe size according to the sum of indoor unit capacity which will be connected after the branch.

Indoor unit capacity (kW)	Pipe size (mm)		
	Liquid pipe	Low pressure gas pipe	High pressure gas pipe
15.0 kW and below	Ø 9.52	Ø 15.88	Ø 15.88
Over 15.0 kW ~ 22.4 kW and below		Ø 19.05	
Over 22.4 kW ~ 28.1 kW and below		Ø 22.22	
Over 28.1 kW ~ 33.6 kW and below	Ø 12.70	Ø 28.58	Ø 19.05
Over 33.6 kW ~ 45.0 kW and below			
Over 45.0 kW ~ 50.4 kW and below	Ø 15.88	Ø 34.92	Ø 22.22
Over 50.4 kW ~ 63.3 kW and below			
Over 63.3 kW ~ 70.3 kW and below	Ø 19.05	Ø 41.28	Ø 28.58
Over 70.3 kW ~ 98.4 kW and below			
Over 98.4 kW ~ 105.5 kW and below	Ø 19.05	Ø 41.28	Ø 28.58
Over 105.5 kW ~ 135.2 kW and below			
Over 135.2 kW ~ 169.0 kW and below	Ø 22.22	Ø 53.98	Ø 34.92
Over 169.0 kW			

9 Installation

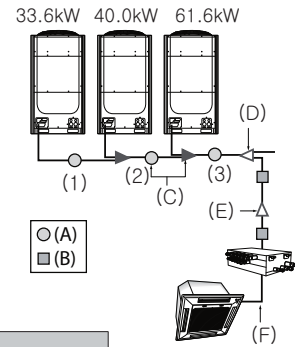

- ③ Size of the pipe between the branch joint and the indoor unit
Make a selection according to outdoor unit capacity.

Indoor unit capacity (kW)	Pipe size (O.D. mm)	
	Liquid pipe	Gas pipe
6.0 kW and below	Ø 6.35	Ø 12.70
7.1 kW ~ 16.0 kW and below	Ø 9.52	Ø 15.88
20.0 kW ~ 23.0 kW and below	Ø 9.52	Ø 19.05
Over 23.0 kW	Ø 9.52	Ø 22.22

- ④ Branch joint

► Branch joint between outdoor units (C)

Classification	Model name	Specification (kW)
Liquid/Low pressure Y-joint (C)	MXJ-TA3419M	135.2 kW and below
	MXJ-TA4122M	Over 140.2 kW
High pressure Y-joint (C)	MXJ-TA3100M	135.2 kW and below
	MXJ-TA3800M	Over 140.2 kW

► First branch joint (D)

Make a selection according to outdoor unit capacity.

Classification	Outdoor unit capacity (kW)	Model name of the branch joint
Liquid/Low pressure Y-joint (C)	40.0 kW and below	MXJ-YA2512M
	45.0 kW	MXJ-YA2812M
	50.4 kW ~ 67.2 kW	MXJ-YA2815M
	73.6 kW ~ 95.2 kW	MXJ-YA3419M
	101.6 kW ~ 135.2 kW	MXJ-YA4119M
	140.2 kW and over	MXJ-YA4422M
High pressure Y-joint (C)	22.4 kW	MXJ-YA1500M
	28.0 kW ~ 67.2 kW	MXJ-YA2500M
	73.6 kW ~ 135.2 kW	MXJ-YA3100M
	140.2 kW and over	MXJ-YA3800M

► Branch joint (E)

Select a branch joint according to the sum of indoor unit capacity which will be connected after the branch.

Classification	Model name	Specification (kW)
Y-joint (E)	MXJ-YA1509M	15.0 kW and below
	MXJ-YA2512M	Over 15.0 kW ~ 40.0 kW and below
	MXJ-YA2812M	Over 40.0 kW ~ 45.0 kW and below
	MXJ-YA2815M	Over 45.0 kW ~ 70.3 kW and below
	MXJ-YA3419M	Over 70.3 kW ~ 98.4 kW and below
	MXJ-YA4119M	Over 98.4 kW ~ 135.2 kW and below
	MXJ-YA4422M	Over 135.2 kW
Y-joint (E) (Only H/R)	MXJ-YA1500M	22.4 kW and below
	MXJ-YA2500M	Over 22.4 kW ~ 70.3 kW and below
	MXJ-YA3100M	Over 70.3 kW ~ 135.2 kW and below
	MXJ-YA3800M	Over 135.2 kW

9 Installation

(3) Additional refrigerant

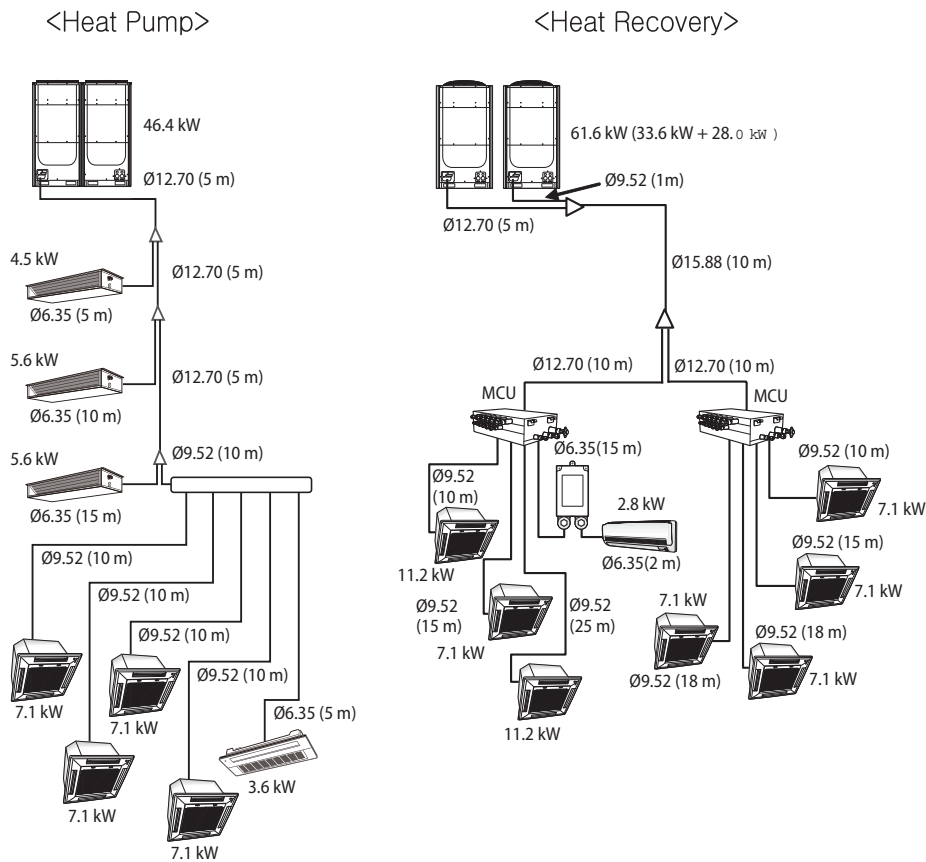

► Basic amount of refrigerant within the outdoor unit (kg)

- Amount of additional refrigerant has to be calculated based on the sum of all liquid pipe length.

Classification	AM080FXVAG*	AM100FXVAG*	AM120FXVAG*	AM140FXVAG*	AM160FXVAG*
Basic type	5.5	5.2	5.5	7.7	7.4
Classification	AM180FXVAG*	AM200FXVAG*	AM220FXVAG*	AM240HXVAG*	AM260HXVAG*
Basic type	8.7	8.4	8.4	14.3	14.3

► Amount of additional refrigerant depending on the pipe size (@)

- Amount of additional refrigerant has to be calculated based on the sum of all liquid pipe length.

- For the indoor unit already connected to EEV kit, the additional refrigerant charging is 0.01kg per meter regardless of the pipe size.

Size of liquid pipe	Ø 6.35	Ø 9.52	Ø 12.70	Ø 15.88	Ø 19.05	Ø 22.22	Ø 25.40	Ø 28.58
Additional amount (kg/m)	0.02	0.06	0.125	0.18	0.27	0.35	0.53	0.65

9 Installation

► Amount of additional refrigerant for each indoor unit (b)

Capacity (kW)	1.5	1.7	2.2	2.8	3.6	4.5	5.6	6	7.1	8.2	9	11.2	12.8	14	16	18	22	22.4	28	32	50	500 CMH	1000 CMH
Model																							
Slim 1way cassette (JSF) (AM***FN1DEH*)			0.25	0.25	0.25																		
Interior 1way cassette (AM***HN1DEH*)		0.15	0.15																				
2way cassette (AM***FN2DEH*)							0.31	0.47															
4Way Casette S (AM***FN4DEH*)						0.45	0.45	0.45	0.45	0.57	0.69	0.69											
Floor Standing Unit (AM***FNFDEH*)					0.22	0.32	0.32																
ERV plus (AM***FNKDEH*)																						0.11	0.36
4way cassette S (600 x 600) (AM***FNNDEH*)	0.29		0.29	0.29	0.29	0.37	0.37	0.37															
Slim duct (AM***FNLDEH*)		0.17	0.17	0.17	0.26	0.35	0.35	0.45		0.42	0.42	0.62	0.62										
MSP duct (AM***FNMDEH*)			0.24	0.24	0.24	0.28	0.28	0.28		0.32	0.54	0.68	0.68										
Ceiling (AM***FNCDEH* / AM***JNCDKH*)							0.39	0.39			0.56	0.95											
Console (AM***FNJDEH*)				0.27	0.27	0.27																	
Neo forte (AM***FNTDEH*)	0.24		0.24	0.24	0.24	0.36	0.36																
Neo forte (with EEV) (AM***FNQDEH*)	0.34		0.34	0.34	0.34	0.51	0.51	0.51															
AR5000 (AM***JNADKH*)	0.16		0.16	0.19	0.25	0.25	0.52	0.52	0.52														
AR5000 (with EEV) (AM***JNVDKH*)	0.22		0.22	0.25	0.34	0.34	0.71	0.71	0.71														
HSP duct (AM***FNHDEH*)												0.68	0.68	0.68		1.18	1.18						
Big duct (AM***JNCDKH*)																1.15	1.15						
Hydro Unit HE (AM***FNBD***)															0.6						0.7	1.2	
Hydro Unit HT (AM***FNBF***)																							
MCU (MCU-S*NEE*N)																							

► If AHU kit is included among the indoor units, you must add 0.063kg of refrigerant for every 1kW of the AHU capacity increase.

► Method to calculate total amount of additional refrigerant

- Amount of additional refrigerant depending on the pipe length (a)
- Amount of additional refrigerant for each indoor unit (b) = Σ(Amount of additional refrigerant for each connected indoor unit)
Refer to the table
- Total amount of additional refrigerant = a+b

Sum of total amount of additional refrigerant and the basic amount of refrigerant should not exceed 100kg. If the refrigerant exceeds 100kg, separate the module so that weight of the refrigerant doesn't exceed 100kg.

Ex.) For AM200FXVAGT, basic amount of refrigerant is 8.4kg, therefore total amount of additional refrigerant (a+b) should not exceed 91.6 kg.

9 Installation

► Example of refrigerant calculation for HP models

Classification	Size of liquid pipe	Length (m)	Unit amount of refrigerant (kg/m)	Amount of additional refrigerant (kg)	Total amount of additional refrigerant (kg)
				×	$\Sigma(\times)$
Liquid pipe ()	Ø 6.35	35	0.02	0.7	5.575
	Ø 9.52	50	0.06	3.0	
	Ø 12.70	15	0.125	1.875	

Classification	Model name of indoor unit	Number of units	Unit amount of refrigerant (kg/EA)	Amount of additional refrigerant (kg)	Total amount of additional refrigerant (kg)
				×	$\Sigma(\times)$
Indoor unit ()	4way cassette (AM071FN4DEH*)	4	0.45	1.80	3.10
	Slim duct (AM056FNLDEH*)	2	0.35	0.70	
	Slim duct (AM045FNLDEH*)	1	0.35	0.35	
	1way cassette (AM036FN1DEH*)	1	0.25	0.25	

- Total amount of refrigerant (@+b) = 5.575+3.10 = 8.675 (kg)

► Example of refrigerant calculation for HR models

Classification	Size of liquid pipe	Length (m)	Unit amount of refrigerant (kg/m)	Amount of additional refrigerant (kg)	Total amount of additional refrigerant (kg)
				×	$\Sigma(\times)$
Liquid pipe ()	Ø 6.35	15	0.02	0.3	11.965
	Ø 9.52	112	0.06	6.72	
	Ø 12.70	25	0.125	3.125	
	Ø 15.88	10	0.18	1.8	
	Ø 6.35 (EEV Kit ~ indoor unit)	2	0.01	0.02	

Classification	Model name of indoor unit	Number of units	Unit amount of refrigerant (kg/EA)	Amount of additional refrigerant (kg)	Total amount of additional refrigerant (kg)
				×	$\Sigma(\times)$
Indoor unit ()	4way cassette (AM071FN4DEH*)	5	0.45	2.25	4.66
	4way cassette (AM112FN4DEH*)	2	0.57	1.14	
	Neo forte (AM028FNTDEH*)	1	0.27	0.27	
	MCU	2	0.5	1	

- Total amount of refrigerant (@+b) = 11.965+4.66 = 16.625 (kg)

9 Installation

3) Temper grade and minimum thickness of the refrigerant pipe

Outer diameter (mm)	Minimum thickness (mm)	Temper grade
Ø 6.35	0.70	Annealed
Ø 9.52	0.70	
Ø 12.70	0.80	
Ø 15.88	1.00	
Ø 19.05	0.90	Drawn
Ø 22.22	0.90	
Ø 25.40	1.00	
Ø 28.58	1.10	
Ø 31.75	1.10	
Ø 34.92	1.21	
Ø 38.10	1.35	
Ø 41.28	1.43	
Ø 44.45	1.60	
Ø 50.80	2.00	
Ø 53.98	2.10	

※For pipes larger than Ø 19.05, drawn type (C1220T-1/2H or C1220T-H) type copper pipe must be used. If a annealed type (C1220T-O) copper pipe is used, pipe may break due to its low pressure resistance and cause personal injury.

9 Installation

4) Examples of refrigerant pipe installation

(1) Heat Pump

<Using Y-joint>

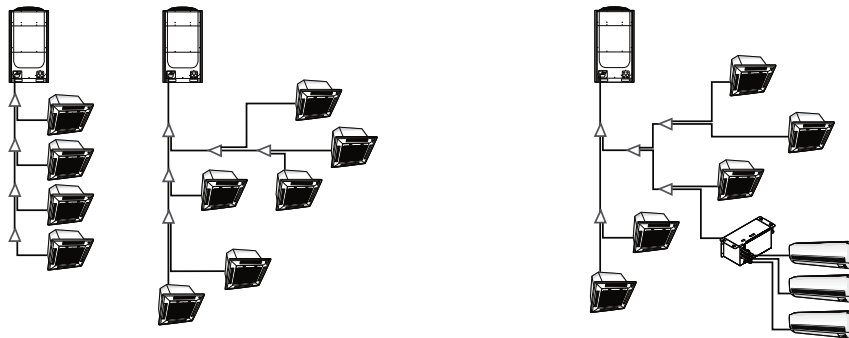

<Using distribution header>

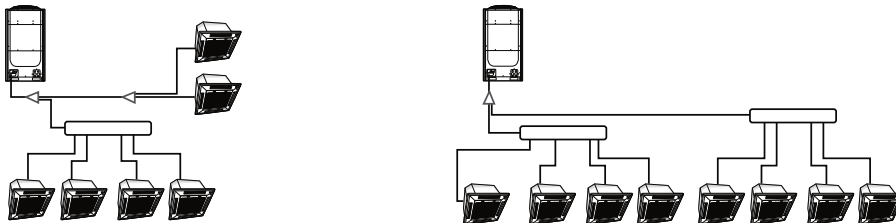

(2) Heat Recovery

<Using Y-joint>

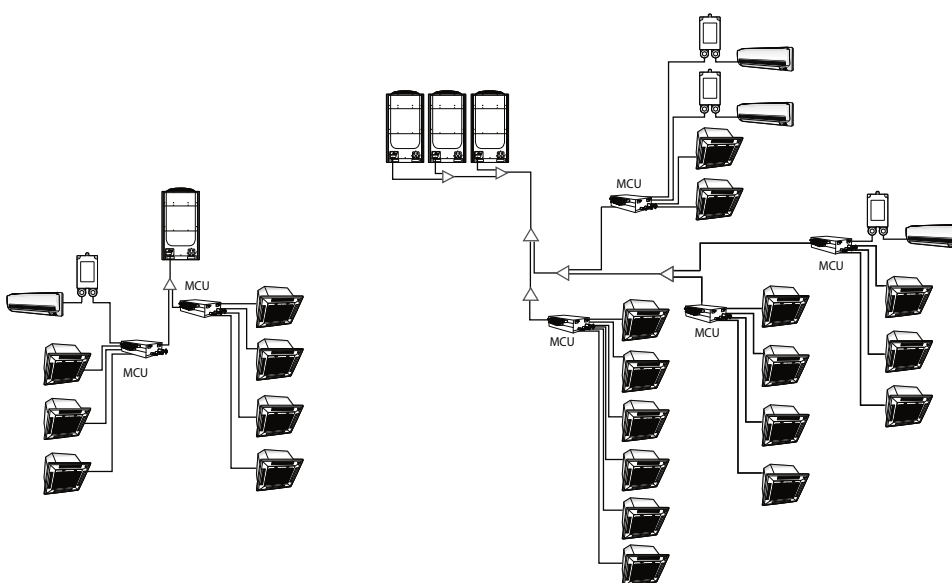

9 Installation

5) Allowable length of the refrigerant pipe and the installation examples

(1) Heat Pump

Classification	Single Installation	Module installation
Installing only with Y-joint		
Installing with Y-joint and distribution header		
Installing only with distribution header		

Classification				Example	Remarks	
Maximum allowable length of pipe	Outdoor unit ~ Indoor unit	Actual length (Equivalent length)	200m and below (220m and below)	Installing only with Y-joint	$a+b+c+d+e+f+g+p \leq 200m(220m)$	Equivalent length Y-joint: 0.5 m, Distribution header: 1 m
				Installing with Y-joint and distribution header	$a+b+h \leq 200m (220m),$ $a+i+k \leq 200m (220m)$	
				Installing only with distribution header	$a+i \leq 200m (220m)$	
	Total length of pipe (m)	1,000 m or less	Installing only with Y-joint	-	-	
			Installing with Y-joint and distribution header	$a+b+c+d+e+f+g+p+h+i \leq 1000m$	-	
			Installing only with distribution header	$a+b+c+d+e+f+g+p+h+i \leq 1000m$	-	
Outdoor unit ~ Outdoor unit (Module installation)	Pipe length	10 m or less	$r \leq 10 m, s \leq 10 m, t \leq 10 m$			
	Equivalent length	13 m or less	$r \leq 13m, s \leq 13m, t \leq 13m$			

9 Installation

Classification		Example		Remarks	
Maximum allowable height difference of pipe	Outdoor unit ~ Indoor unit	110/40m <small>Note 2)</small>	H1 ≤ 110/40m		
	Indoor unit ~ Indoor unit	50m or less	H2 ≤ 50m		
		But, when AM***FNQDEH* is installed, H2 is 15 m or less			
Maximum allowable length after branch joint	First branch joint ~ Farthest Indoor unit	Pipe length	45 m or less	b+c+d+e+f+g+p ≤ 45m, i ≤ 45 m	-
			45 m~90 m <small>Note 1)</small>	Required conditions must be satisfied	Exclude H/R

EEV kit		Model name		Remarks	
EEV kit ~ Indoor unit	Actual pipe length	2 m	MEV-E24SA	1 indoor	Apply to products without EEV (Wall mount & ceiling)
			MEV-E32SA		
	20 m or less	2 indoor	MXD-E24K132A		
			MXD-E24K200A		
			MXD-E32K200A		
		3 indoor	MXD-E24K232A		
			MXD-E24K300A		
			MXD-E32K224A		
		MXD-E32K300A			

Classification	Condition	Example
First branch joint ~ Farthest Indoor unit	$45m \leq b+c+d+e+f+g+p \leq 90m$: branch pipes (b, c, d, e, f, g) size must be increased by 1 grade	
Total length of extended pipe	If the size of pipe (main pipe), between the first branch joint and the outdoor unit, is not increased by 1 grade, $a+(b+c+d+e+f+g) \times 2 + h+i+j+k+l+m+n+p \leq 1000$ m	
	If the size of pipe (main pipe), between the first branch joint and the outdoor unit, is increased by 1 grade, $(a+b+c+d+e+f+g) \times 2 + h+i+j+k+l+m+n+p \leq 1000$ m	
Each Y-joint ~ Each indoor unit	$h, i, j, \dots p \leq 45$ m	
Difference between the distance of the outdoor unit to the farthest indoor unit and nearest indoor unit $\leq 45m$, $(a+b+c+d+e+g+p)-(a+h) \leq 45m$		

Note 1) Required condition

Note 2) When indoor unit is located at higher level than outdoor unit, allowable height difference is 40m, but when the indoor unit is located at lower level than outdoor unit, allowable height difference is 110m (If the height difference is over 50m, decide if you need to install PDM kit)
 Model name of the PDM kit: MXD-A38K2A, MXDA12K2A, MXD-A58K2A

9 Installation

(2) Heat Recovery

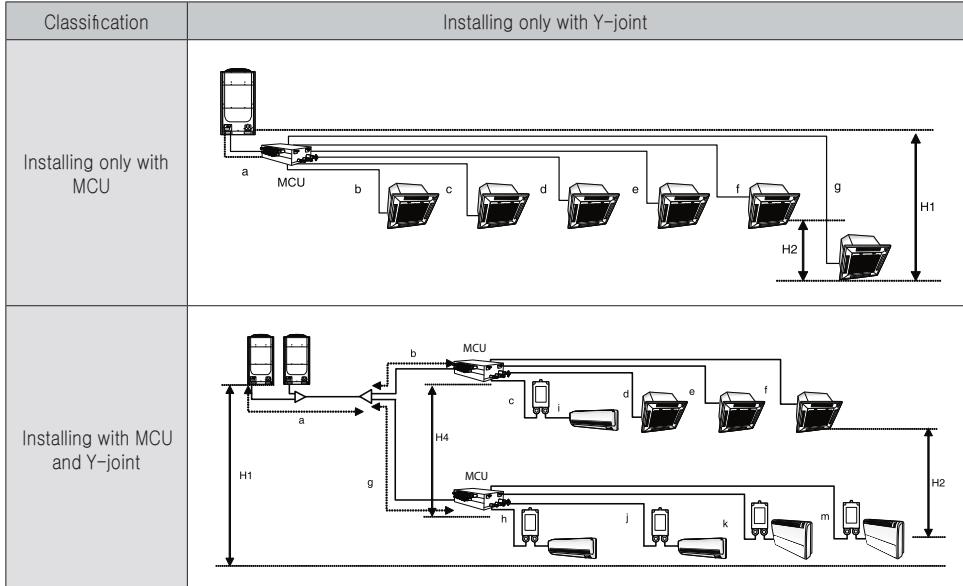

Items		Examples		Remarks	
Max. piping length	Outdoor ~ Indoor unit	Piping (Equivalent piping)	200 m below (220 m below)	Using MCU only $a+g \leq 200 \text{ m (220 m)}$	Equivalent pipe length Y joint : 0.5 m Header : 1 m MCU : 1 m
				Using Y-joint and MCU $a+g+m \leq 200 \text{ m (220 m)}$	
		Total piping	1000 m below	Using MCU only $a+b+c+d+e+f+g \leq 1000 \text{ m}$	-
				Using Y-joint and MCU $a+b+c+d+e+f+g+p+h+i+j+k+m \leq 1000 \text{ m}$	-
Outdoor unit ~ Outdoor unit (Module installation)	Piping	10 m below	$r \leq 10, s \leq 10, t \leq 10 \text{ m}$		
	Equivalent piping	13 m below	$r \leq 13, s \leq 13, t \leq 13 \text{ m}$		
Level difference	Outdoor ~ Indoor unit	Piping	110 m / 40 m ^{Note1)}	$H1 \leq 110 \text{ m/40 m}$	-
	Indoor ~ Indoor unit	Piping	15 m below	$H2 \leq 15 \text{ m}$	-
	MCU ~ MCU	Piping	15 m below	$H4 \leq 15 \text{ m}$	-
Allowable length after branch	The first branch ~ the farthest indoor unit	Piping	45 m below	Using MCU only	45 m
				Using Y-joint and MCU	$g+m \leq 45 \text{ m}$

Distribution kit		Model		Remarks
Allowable	From distribution kit to indoor unit	2 m	MEV-E24SA, MEV-E32SA (For 1 indoor unit)	For wall-mounted & ceiling indoor unit

Note 1) As an outdoor unit is located in a lower position than indoor unit, level difference is 40 m. If outdoor unit is located in a higher position than indoor unit, level difference is 110 m or under. (If the level difference is higher than 50 m, make a decision simulating by PDM kit installation guide software whether the PDM kit should be installed or not.)

*PDM kit: Pressure Drop Modulation kit

※Total refrigerant amount of the system must be less than 100 kg. If total refrigerant amount of system is over than 100 kg, the system has to be divided into smaller system, each less than 100 kg.

9 Installation

6) Installing the MCU

(1) MCU specification

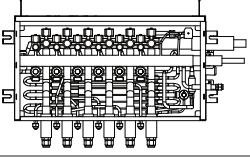
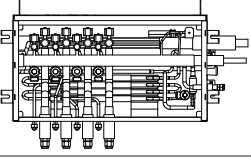
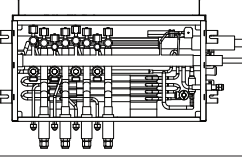
Model	MCU-S6NEE1N	MCU-S4NEE1N	MCU-S4NEE2N
Exterior of MCU			
Number of connectable indoor units	Up to 6 units	Up to 4 units	Up to 2 units ※ Refer the detail information of installation manual
Maximum capacity of connectable indoor units	56 kW	56 kW	56 kW

(2) Installing the indoor units

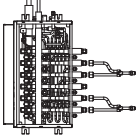
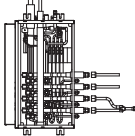
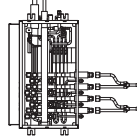
Model	MCU-S6NEE1N	MCU-S4NEE1N	MCU-S4NEE2N
Example installing			
Installing indoor units	<p>The indoor unit's capacity which is under 14kW, can be connected in the MCU. Do not connect the indoor unit's capacity exceeds 14kW.</p> <p>Single capacity range under 10.0kW</p> <ul style="list-style-type: none"> - Connect the liquid, gas pipe of indoor unit to each single port in MCU. <p>Single capacity range between 11.2kW to 14.0kW</p> <ul style="list-style-type: none"> - Join two ports in the MCU with offered Y-connector(liquid, gas), then connect to indoor unit as above. <p>* Reference of continuous cooling.</p> <p>In case of continuous cooling at below -5 °C(23 °F) ambient condition, join two ports in the MCU with offered Y-connector, then connect to indoor unit even though unit's capacity is between 5.0kW to 10.0kW.</p> <p>Option switch and key function needs to be set. Detail information refer to pages 87~89.</p>		<p>The indoor unit's capacity which is greater than or equal to 11.2kW, can be connected in the MCU. Do not connect the indoor unit's capacity not exceeding 11.2kW.</p> <p>Single capacity range between 11.2kW to 28.0kW</p> <ul style="list-style-type: none"> - Join two ports in the MCU with offered Y-connector(liquid, gas), then connect to indoor unit as above.

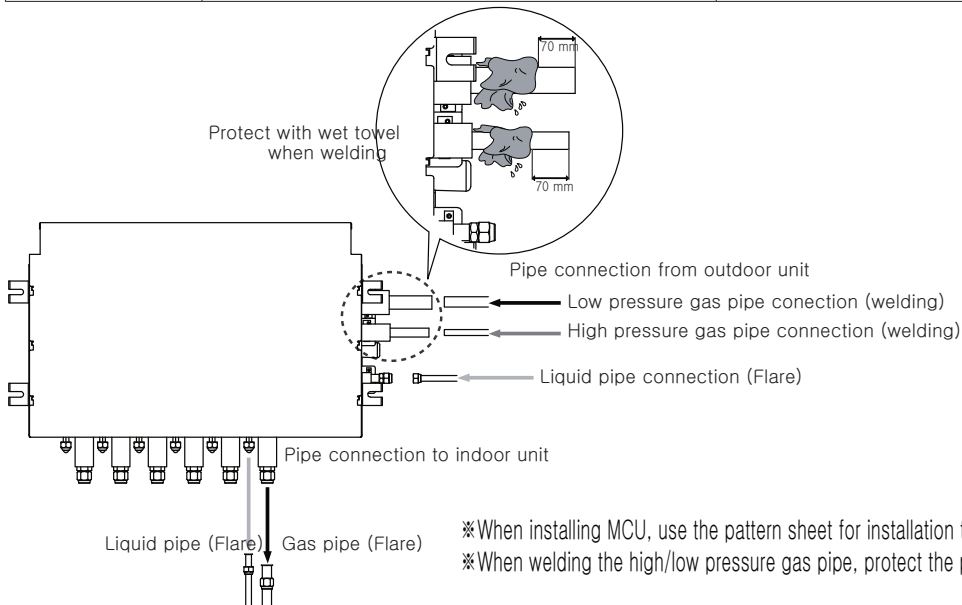

9 Installation

4. Electrical wiring work

1) Specification of the circuit breaker and power cable

Standard (Heat pump)

Model	MCA	MFA
AM080FXVAGH	18.0	25
AM100FXVAGH	21.1	32
AM120FXVAGH	25.0	32
AM140FXVAGH	25.0	32
AM160FXVAGH	32.0	40
AM180FXVAGH	39.1	50
AM200FXVAGH	42.5	63
AM220FXVAGH	44.5	63
AM240HXVAGH	55.0	63
AM260HXVAGH	58.0	63

Standard module (Heat pump)

Model	MCA	MFA
AM280HXVAGH1	57.0	63
AM300HXVAGH1	64.1	75
AM320HXVAGH1	67.5	75
AM340HXVAGH1	69.5	80
AM360HXVAGH1	69.5	80
AM380HXVAGH1	76.5	90
AM400HXVAGH1	83.0	100
AM420HXVAGH1	87.0	100
AM440HXVAGH1	89.0	100
AM460HXVAGH1	94.5	125
AM480HXVAGH1	94.5	125
AM500HXVAGH1	101.5	125
AM520HXVAGH1	108.6	125
AM540HXVAGH1	112.0	125
AM560HXVAGH1	114.0	125
AM580HXVAGH1	114.0	125
AM600HXVAGH1	121.0	150
AM620HXVAGH1	128.1	150
AM640HXVAGH1	131.5	150
AM660HXVAGH1	133.5	150
AM680HXVAGH1	139.0	175
AM700HXVAGH1	139.0	175
AM720HXVAGH1	146.0	175
AM740HXVAGH1	153.1	175
AM760HXVAGH1	156.5	175
AM780HXVAGH1	158.5	175
AM800HXVAGH1	158.5	175

9 Installation

Compact module (Heat pump)

Model	MCA	MFA
AM360HXVAGH2	80.0	90
AM380HXVAGH2	83.0	100
AM460HXVAGH2	100.5	125
AM480HXVAGH2	102.5	125
AM500HXVAGH2	113.0	125
AM520HXVAGH2	116.0	150
AM580HXVAGH2	125.5	150
AM600HXVAGH2	127.5	150
AM620HXVAGH2	138.0	175
AM640HXVAGH2	141.0	175
AM680HXVAGH2	144.0	175
AM700HXVAGH2	147.0	175
AM720HXVAGH2	157.5	175
AM740HXVAGH2	160.5	200
AM760HXVAGH2	171.0	200
AM780HXVAGH2	174.0	200

Single (Heat recovery)

Model	MCA	MFA
AM080FXVAGR	18.0	25
AM100FXVAGR	21.1	32
AM120FXVAGR	25.0	32
AM140FXVAGR	25.0	32
AM160FXVAGR	32.0	40
AM180FXVAGR	39.1	50
AM200FXVAGR	42.5	63
AM220FXVAGR	44.5	63
AM240FXVAGR	50.0	63
AM260FXVAGR	50.0	63
AM280FXVAGR	57.0	63
AM300FXVAGR	64.1	75
AM320FXVAGR	67.5	75
AM340FXVAGR	69.5	80
AM360FXVAGR	69.5	80
AM380FXVAGR	76.5	90
AM400FXVAGR	85.0	100
AM420FXVAGR	87.0	100
AM440FXVAGR	89.0	100
AM460FXVAGR	94.5	125
AM480FXVAGR	94.5	125
AM500FXVAGR	101.5	125
AM520FXVAGR	108.6	125
AM540FXVAGR	112.0	125
AM560FXVAGR	114.0	125
AM580FXVAGR	114.0	125
AM600FXVAGR	121.0	150
AM620FXVAGR	129.5	150
AM640FXVAGR	131.5	150
AM660FXVAGR	133.5	150
AM680FXVAGR	139.0	175
AM700FXVAGR	139.0	175
AM720FXVAGR	146.0	175
AM740FXVAGR	153.1	175
AM760FXVAGR	156.5	175
AM780FXVAGR	158.5	175
AM800FXVAGR	158.5	175

9 Installation

※ When installing outdoor units in module, select the power supply cable according to the sum of outdoor unit capacity.
(Refer to the table for each model)

※ Power Supply cords of parts of appliances for outdoor use shall not be lighter than polychloroprene sheathed flexible cord. (Code designation IEC:60245 IEC 66 / CENELEC: H07RN-F)

Ex.) AM500*XVA**

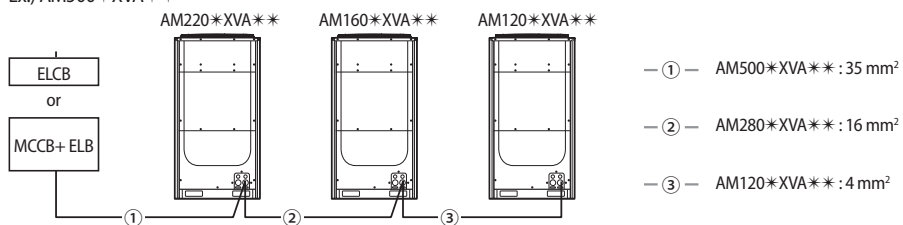

9 Installation



- This device is intended for the connection to a power supply system with a maximum permissible system impedance shown in the table (on the left page) at the interface point (power service box) of the user's supply.
- The user must ensure that this device is connected only to a power supply system which fulfills the requirement above. If necessary, the user can ask the public power supply company for the system impedance at the interface point.
- This equipment complies with IEC 61000-3-12 provided that the short-circuit power S_{sc} is greater than or equal to $S_{sc}(*2)$ at the interface point between the user's supply and the public system. It is the responsibility of the installer or user of the equipment to ensure, by consultation with the distribution network operator if necessary, that the equipment is connected only to a supply with a short-circuit power S_{sc} greater than or equal to $S_{sc}(*2)$.

[$S_{sc}(*2)$]

Model	S_{sc} [MVA]	Model	S_{sc} [MVA]
AM080FXVAG*	3.3	AM180FXVAG*	7.6
AM100FXVAG*	4.5	AM200FXVAG*	8.1
AM120FXVAG*	5.3	AM220FXVAG*	8.6
AM140FXVAG*	5.3	AM240HXVAG*	11.7
AM160FXVAG*	6.8	AM260HXVAG*	8.6



Caution for electrical work

- You must install ELCB or MCCB + ELB
 - ELCB: Earth leakage breaker
 - MCCB: Molded case circuit breaker
 - ELB: Earth leakage breaker
- Do not operate the outdoor unit before completing the refrigerant pipe work.
- Do not disconnect or change the cable inside the product. It may cause damage to the product.
- Specification of the power cable is selected based on following installation condition; culvert installation/ ambient temperature 30 °C/ single multi conductor cables. If the condition is different from the ones stated, please consult an electrical installation expert and re-select the power cable.
 - If the length of power cable exceed 50m, re-select the power cable considering the voltage drop.
- Use a power cable made out of incombustible material for the insulator (inner cover) and the sheath (outer cover).
- Do not use the power cable with the core wire exposed due to insulator damage occurred during removal of the sheath. When the core wire is exposed, it may cause fire.

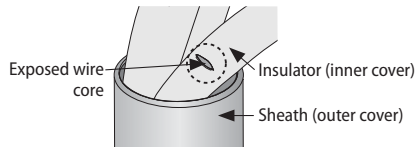

<The example of exposed core wire>

9 Installation

2) Power wiring diagram

(1) Supplying 3 phase 4 wires (380-415 V~)

- ▶ Connect a power cable of the outdoor unit after checking that R-S-T-N (3 phase 4 wire) is properly connected. (If the 380-415 V power is supplied to the N phase, PCB and other electrical part will be damaged.)
- ▶ Communication cable between indoor and outdoor units and communication cable between outdoor units has no polarity.
- ▶ Arrange the cables with a cable tie.
- ※ ELCB and ELB must be installed since there is risk of electric shock or fire when they are not installed.

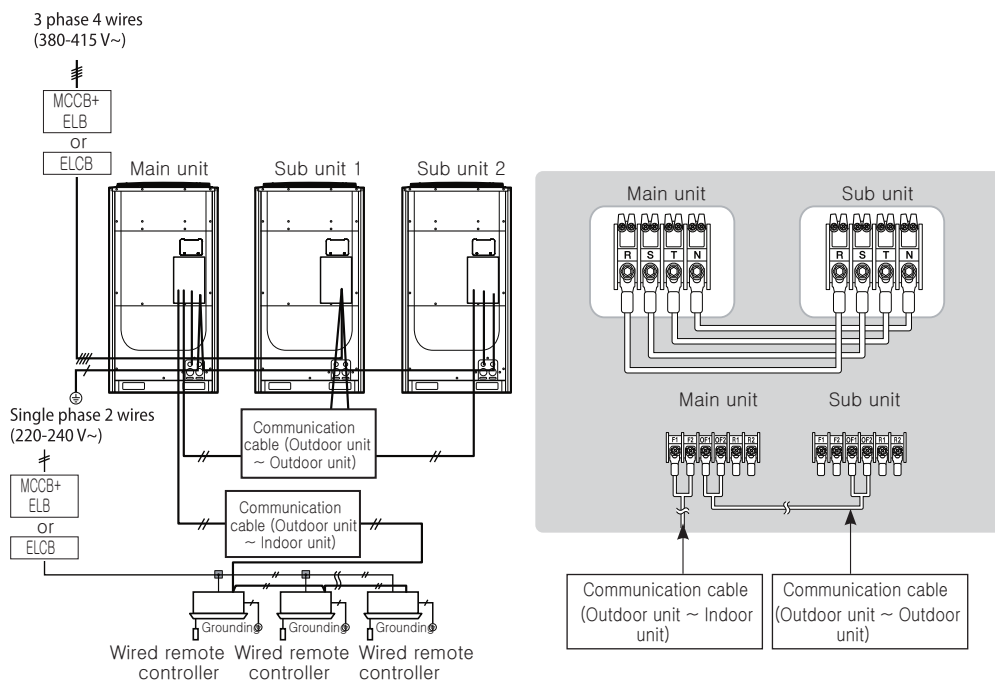

3) Installing the Solution device

- ▶ When the number of indoor units installed with the outdoor unit is 16 or less

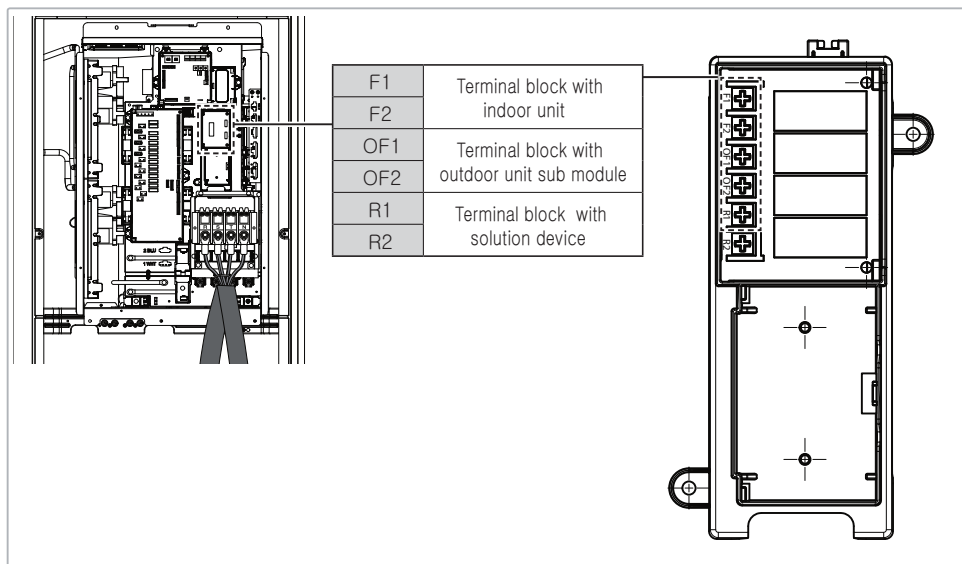

9 Installation

4) Connecting the MCU

(1) Example 1

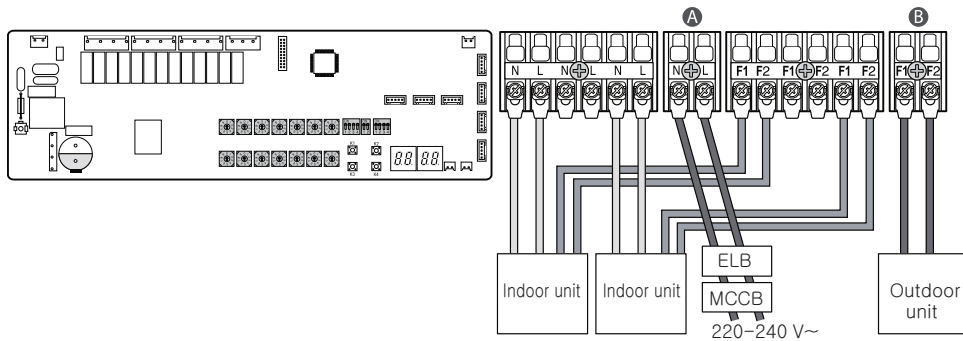

(2) Example 2

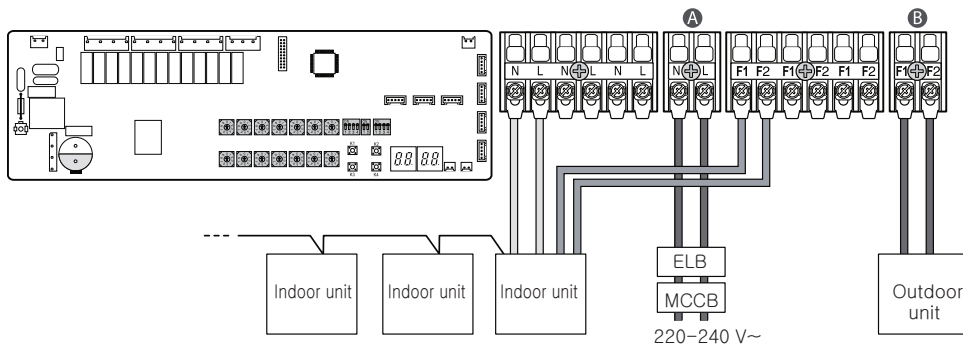

- ▶ A Power must be supplied to the MCU separately from the outdoor unit.
- ▶ B Connect the communication cable of the outdoor unit (F1, F2) to the communication cable of the MCU (F1, F2)

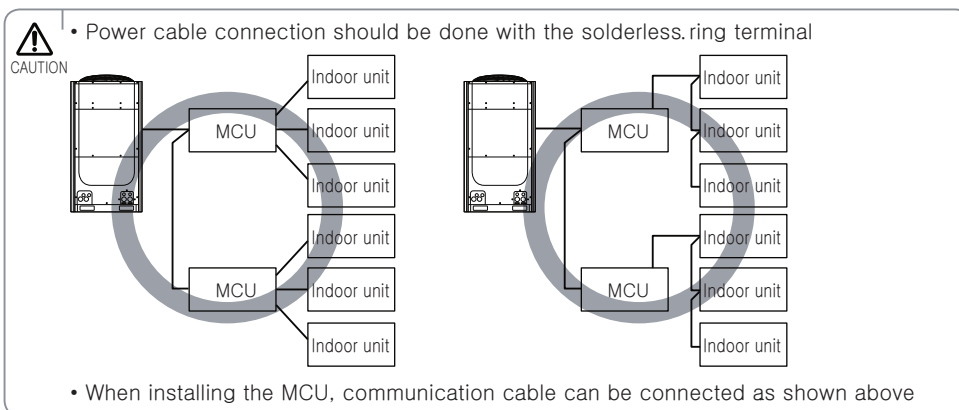

9 Installation

5) Grounding work

(1) Grounding the power cable

- ▶ The standard of grounding may vary according to the rated voltage and installation place of the air conditioner.
- ▶ Ground the power cable according to the following table.

Installation place	Power condition	
	Voltage to ground is lower than 150V	Voltage to ground is over 150V
High humidity	Must perform the grounding work 3. ^{Note 1)} (Including the case where earth leakage breaker is installed)	
Average humidity	Perform grounding work 3. ^{Note 1)}	Must perform the grounding work 3. ^{Note 1)} (Including the case where earth leakage breaker is installed)
Low humidity	Perform grounding work 3, if possible, for your safety. ^{Note 2)}	

Note 1) About grounding work 3.

- Grounding work must be done by an expert (with qualification).
- Check if the grounding resistance is lower than 100Ω. When installing a earth leakage breaker (that can cut the electric circuit within 0.5 second in case of a short circuit), allowable grounding resistance should be 30~500Ω.

Note 2) Grounding at dry place

- The grounding resistance should be lower than 100Ω. Even in worst case, grounding resistance should be lower than 250Ω.

(2) Performing the grounding work

- ▶ Use a rated grounding cable by referring to the specification of the electric cable for the outdoor unit.

※When using the exclusive grounding terminal
(When the grounding terminal is already built on the house)

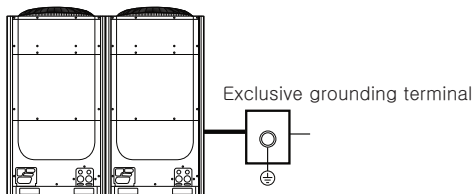

※When using grounding of the switch board

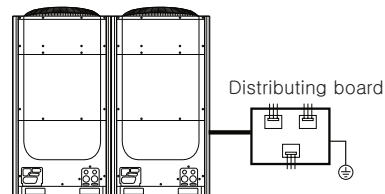

2016. 11
Ver.1.6



Samsung Electronics Co., LTD.
B2B PM / SE

Head Office (Suwon Korea) 129, Samsung-Ro, Yeongtong-Gu, Suwon City, Gyeonggi-Do, Korea 443-742

Website : www.samsung.com Email : airconditioner@samsung.com

Images and data in this book may subject to change without prior notice.