

# TOSHIBA

AIR CONDITIONER (SPLIT TYPE)

## Owner's Manual

Wireless remote controller kit

Model name: \_\_\_\_\_

**RBC-AX32U(W)-E**

**RBC-AX32U(WS)-E**

<b>Generic model name</b>	<b>Wireless remote controller model name</b>
RBC-AX32U(W)-E	WH-L11SE
	<b>Signal receiving unit model name</b>
	SX-W1NE

<b>Generic model name</b>	<b>Wireless remote controller model name</b>
RBC-AX32U(WS)-E	WH-L11SE
	<b>Signal receiving unit model name</b>
	SX-W2NE

Thank you very much for purchasing TOSHIBA Remote controller for Air Conditioner. Please read this owner's manual carefully before using your Remote controller for Air Conditioner

- Be sure to obtain the "Owner's manual" and "Installation manual" from constructor (or dealer).

Request to constructor or dealer

- Please clearly explain the contents of the Owner's manual and hand over it.

## Contents

---

<b>1</b>	<b>Precautions for safety</b> . . . . .	<b>2</b>
<b>2</b>	<b>Changing batteries</b> . . . . .	<b>3</b>
<b>3</b>	<b>Adjusting clock</b> . . . . .	<b>3</b>
<b>4</b>	<b>Part names and functions</b> . . . . .	<b>4</b>
<b>5</b>	<b>Operating unit</b> . . . . .	<b>7</b>
<b>6</b>	<b>Operating unit with timer</b> . . . . .	<b>10</b>
<b>7</b>	<b>Adjusting louver direction</b> . . . . .	<b>12</b>
<b>8</b>	<b>Mounting remote controller holder</b> . . . . .	<b>12</b>
<b>9</b>	<b>Operating air conditioner without remote controller</b> . . . . .	<b>13</b>
<b>10</b>	<b>Before asking for repair work</b> . . . . .	<b>14</b>

# 1 Precautions for safety

## WARNING

---

### Installation

- Make sure to ask the qualified installation professional in electric work to install the remote controller.  
If the remote controller is inappropriately installed by yourself, it may cause electric shock, fire or other trouble.
- Make sure to install the air conditioner specified by TOSHIBA and ask the exclusive dealer when installing. If the air conditioner is installed by yourself, it may cause electric shock, fire or other trouble.

### Operation

- Prevent any liquid from falling into the remote controller.  
Do not spill juice, water or any kind of liquid.  
It may cause machine failure, electric shock, fire or other trouble.
- When you are aware of something abnormal with the air conditioner (such as smells like something burning), immediately turn off the main power supply switch or circuit breaker to stop the air conditioner, and make contact with the dealer.  
If the air conditioner is continuously operated with something abnormal, it may cause machine failure, electric shock, fire or other trouble.

### Reinstallation and repair

- Do not repair any unit by yourself.  
Whenever the air conditioner needs repair, make sure to ask the dealer to do it.  
If it is repaired imperfectly, it may cause electric shock, fire or other trouble.
  - When reinstalling the air conditioner, contact with the dealer.  
If the installation is insufficient, it may cause electric shock, fire or other trouble.
- 

## CAUTION

---

### Installation

- Do not install the remote controller in a place where its signals do not reach the indoor unit.
- Do not install the remote controller in the place under the direct sunlight and close to any heat source. It may cause machine failure.
- The fluorescent lamp with rapid start system or inverter system may disturb the signal reception. For details, contact with the dealer of the air conditioner you have purchased.

### Operation

- Do not drop or apply strong shock to the remote controller.  
It may cause remote controller failure.
  - Use batteries that meet the specifications.
-

## 2 Changing batteries

### Loading batteries

- 1 Remove the battery cover.
- 2 Insert 2 new batteries (R03 [AAA]) following the (+) and (-) positions.

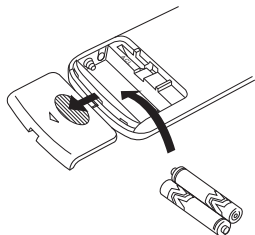

### Removing batteries

- 1 Remove the battery cover.
- 2 Slap the batteries out lightly onto your palm.

### Batteries

- To replace the batteries, use two new batteries (R03 [AAA]).
- In normal use, the batteries will last about one year.
- Replace the batteries if there is no receiving beep from the indoor unit or when the air conditioner cannot be operated using the remote controller.
- To avoid malfunctions by battery leakage, remove the batteries when not using the remote controller for more than one month.

## 3 Adjusting clock

### Setting the clock

Before you start operating the air conditioner, set the clock of the remote controller using the procedures given in this section. The clock panel on the remote controller will indicate the time regardless of whether the air conditioner is in use or not.

### ■ Initial setting

When batteries are inserted in the remote controller the clock panel will indicate AM 0:00 and will flash.

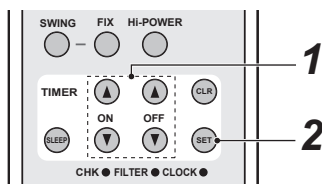

#### 1 TIMER or button

Push the TIMER  or  button to set the current time.

Each push of the TIMER button changes the time in one minute steps.

Pushing the TIMER button continually changes the time in ten minute steps.

#### 2 SET button

Push the SET  button.

The current time is indicated and the clock starts.

### ■ Adjusting clock

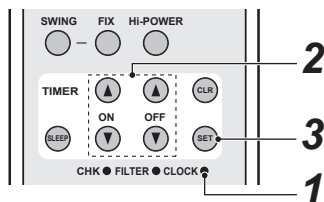

#### 1 CLOCK button

Push the CLOCK  by tip of a pencil. The CLOCK display flashes.

#### 2 TIMER or button

Push the TIMER  or  button to set the current time.

Each push of the TIMER button changes the time by one minute.

Pushing the TIMER button continually changes the time by ten minutes.

#### 3 SET button

Push the SET  button.

The current time is indicated and the clock starts.

# 4 Part names and functions

## Remote controller (WH-L11SE)

- Max. 8 indoor units can be operated by a remote controller as a group.
- Illustration of LCD shown below is for explanation. It may differ from the actual LCD.

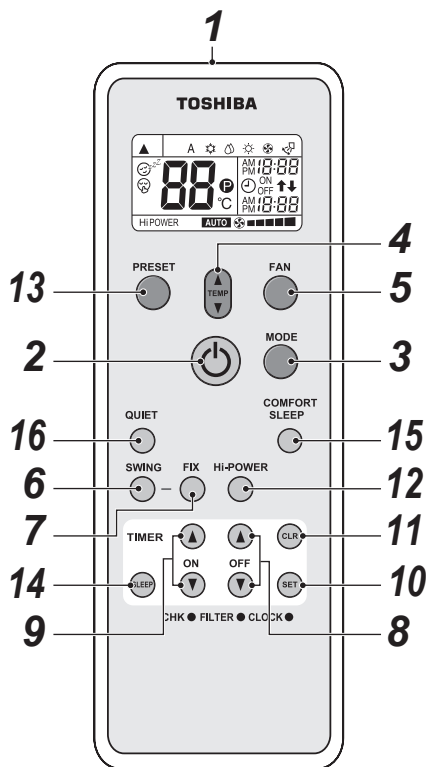

### 1 Infrared signal emitter

Transmits a signal to the indoor unit.

### 2 START/STOP button

Push the button to start operation.

(A receiving beep is heard.)

Push the button again to stop operation.

(A receiving beep is heard.)

If no receiving sound is heard from the indoor unit, push the button twice.

### 3 Mode select button (MODE)

Push this button to select a mode.

Each time you push the button, a mode is selected in a sequence that goes from A : Auto changeover control, : Cool, : Dry, : Heat, : Fan only, and back to A. (A receiving beep is heard.)

### 4 Temperature button ( )

... The set temperature is increased up to 30 °C.

... The set temperature is dropped down to 17 °C. (A receiving beep is heard.)

### 5 Fan speed button (FAN)

Push this button to select fan speed. When you select AUTO, the fan speed is automatically adjusted according to the room temperature.

You can also manually select the desired fan speed.

(LOW , LOW\* , MED ,

MED\* , HIGH )

Five patterns are displayed, but LOW\* is equal to LOW , and MED\* to MED .

(A receiving beep is heard.)

### 6 Auto louver button (SWING)

Push this button to swing the louver.

(A receiving beep is heard.)

Push the SWING button to stop the louver swinging.

(A receiving beep is heard.)

### 7 Set louver button (FIX)

Push this button to adjust the airflow direction.

(A receiving beep is heard.) It cannot be operated by

holding down the button. Push the button with some interval.

### 8 Off timer button (OFF)

Push this button to set the OFF timer.

### 9 On timer button (ON)

Push this button to set the ON timer.

### 10 Reserve button (SET)

Push this button to reserve time settings.

(A receiving beep is heard.)

### 11 Cancel button (CLR)

Push this button to cancel ON timer and OFF timer.

(A receiving beep is heard.)

### 12 High power button (Hi-POWER)

Push this button to start the high power operation.

### 13 PRESET button

Push this button to change the operation mode to the preferred operation mode memorized previously. To memorize the operation mode, push this button for at least 3 seconds during the preferred operation mode. is displayed and the operation mode is memorized.

### 14 SLEEP button

Push this button to start the OFF timer operation that automatically adjusts the room temperature and the fan speed.

You can select the OFF timer time from four durations (1, 3, 5 or 9 hours).

## 15 COMFORT SLEEP button

Push this button to start the OFF timer operation that automatically adjusts the room temperature and the fan speed.

You can select the OFF timer time from four durations (1, 3, 5 or 9 hours).

## 16 QUIET button

Push this button to start quiet operation.

Pushing this button again will restore normal operation.

## ■ Names and functions of indications on wireless remote controller

### Display

All indications, except for clock time indication, are indicated by pushing the START/STOP (⏻) button.

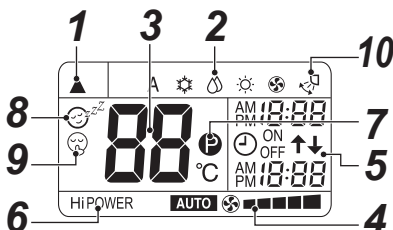

- In the illustration, all indications are indicated for explanation. During operation, only the relevant indications will be indicated on the remote controller.

### 1 Transmission mark

This transmission mark (▲) indicates when the remote controller transmits signals to the indoor unit.

### 2 Mode display

Indicates the current operation mode.

(A : Auto changeover control, ☀ : Cool, ☹ : Dry, ☀ : Heat, 🌀 : Fan only)

### 3 Temperature display

Indicates the temperature setting (17 °C to 30 °C). When you set the operating mode to 🌀 : Fan only, no temperature setting is indicated.

### 4 FAN speed display

Indicates the selected fan speed. AUTO or one of five fan speed levels (LOW ■ , LOW<sup>+</sup> ■■ , MED ■■■ , MED<sup>+</sup> ■■■■ , HIGH ■■■■■ ) can be indicated.

Indicates **AUTO** when the operating mode is ☹ : Dry.

### 5 TIMER and clock time display

The time set for timer operation or clock time is indicated.

The present time is always indicated except for TIMER operation.

### 6 Hi POWER display

Indicates when the high power operation starts. Push the Hi-POWER button to start and push it again to stop the operation.

### 7 Ⓟ (PRESET) display

Indicated when memorizing the preferred operation mode or when it has been memorized.

Also, this icon is indicated when the memorized preferred operation is displayed.

- 8**  **(COMFORT SLEEP) display**  
Indicated during the OFF timer operation that automatically adjusts the room temperature and the fan speed. Each time you push the COMFORT SLEEP button, the display changes in the sequence of 1h, 3h, 5h, and 9h.

- 9**  **(QUIET) display**  
Indicated during the quiet operation.

- 10** **Swing display**  
Indicated during the swinging operation where the horizontal louver automatically moves up and down.

#### NOTE

When both wired remote controller or central controller and wireless remote controller are used, display on the screen of wireless remote controller may differ from the actual operation in some cases.

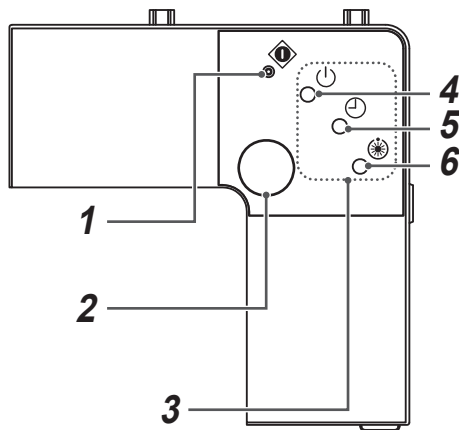

## ■ Signal receiving unit

The signal receiving unit is attached to the indoor unit.



## ⚠ CAUTION

### Disagreement in operation mode

- If “pi, pi” sound is heard, the display lamp goes on, and the  lamp and  lamp flash alternately, the operation is not performed with the desired mode.
- Even if you push START/STOP, MODE, TEMPERATURE buttons when remote controller operation is disabled by the central control or other means, “pi” is heard 5 times and the button operation is not accepted.

- 1** **Temporary operation button**  
(See page 13)

- 2** **Signal receiving part**  
The signal sent from the remote controller is received.

- 3** **Display lamp**  
One of displays flashed while an error occurs. When the display lamp flashes, refer to “Before asking for repair work”.

- 4**  **lamp (Green)**  
This lamp illuminates when unit is on.

- 5**  **lamp (Green)**  
This lamp illuminates while the timer is reserved.

- 6**  **lamp (Orange)**
- In heating operation this lamp illuminates in the following cases;
    - The operation has started.
    - The temp. controller has worked.
    - The unit is under defrost operation.
  - This lamp flashes while a trouble occurs.

# 5 Operating unit

## ■ Cooling / Heating / Fan / Dry operation

### Start

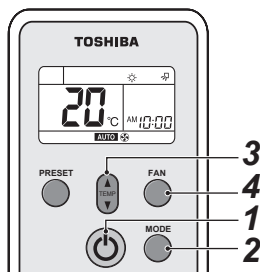

- 1 START/STOP button (⏻)**  
Push this button to start the air conditioner.
- 2 Mode select button (MODE)**  
Select Cool ❄️, Heat 🔥, or Fan only 🌀, Dry ☁️.
- 3 Temperature button (⬆️/⬆️)**  
Set the desired temperature.  
When the air conditioner is in FAN ONLY operation, the temperature display is not indicated.
- 4 Fan speed button (FAN)**  
Set a desired fan speed.

- Five patterns are displayed, but LOW<sup>+</sup> ■■■ is equal to LOW ■, and MED<sup>+</sup> ■■■■■ to MED ■■■.
- The ⏻ OPERATION lamp (green) on the display lamp of the signal receiving unit goes on. And operation starts after approximately 3 minutes.  
(If you select FAN ONLY mode, the unit will start immediately.)
- The 🌀 : Fan only mode does not control temperature.
- **AUTO** appears as the fan speed for the Dry operation, and the fan speed cannot be changed.

### Stop

#### START/STOP button (⏻)

Push this button again to stop the air conditioner.

## ■ Automatic operation (auto changeover)

### Start

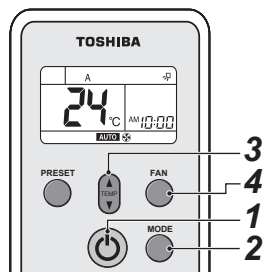

- 1 START/STOP button (⏻)**  
Push this button to start the air conditioner.
- 2 Mode select button (MODE)**  
Select A.
- 3 Temperature button (⬆️/⬆️)**  
Set the desired temperature.
- 4 Fan speed button (FAN)**  
Set a desired fan speed.

- Five patterns are displayed, but LOW<sup>+</sup> ■■■ is equal to LOW ■, and MED<sup>+</sup> ■■■■■ to MED ■■■.
- The ⏻ OPERATION lamp (green) on the display lamp of the signal receiving unit lights.  
The operating mode is selected in accordance with the room temperature and operation starts after approximately 3 minutes.
- If the "A" mode is uncomfortable, you can select the desired conditions manually.

### Stop

#### START/STOP button (⏻)

Push this button again to stop the air conditioner.

### ⚠️ CAUTION

- The Automatic operation is not available for SMMS series units other than Super Heat Recovery Multi types. The receiving unit lamp blinks, and the alarm sound is emitted. Change to another operation mode.
- The alarm sound is also emitted on the Cooling only models, and the Automatic operation is not available.



## ■ High power operation

### High power (Hi POWER)

The Hi POWER (high power operation) mode automatically controls room temperature, airflow and operation mode so that the room is quickly cooled in summer and warmed in winter.



### Setting Hi POWER mode

#### 1 Hi-POWER button

Push the Hi-POWER button after starting any operation. At the same time, the "Hi POWER" mark on the remote controller is indicated.

### Cancelling Hi POWER mode

#### 1 Hi-POWER button

Push the Hi-POWER button once again. At the same time, the "Hi POWER" mark on the remote controller goes out.

### ⚠ CAUTION

- The Hi POWER mode cannot be activated in the DRY and FAN ONLY operation and when the ON TIMER operation is reserved.
- When Auto changeover control mode is selected, the air conditioner does not automatically control the room temperature.

## ■ Quiet operation

The QUIET mode provides quiet operating status by automatically setting the fan speed to the lowest speed.

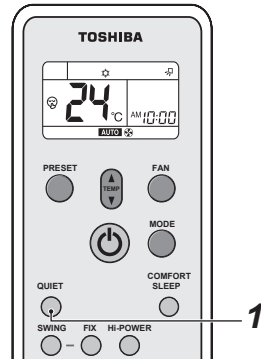

### Setting QUIET mode

#### 1 QUIET button

Push the QUIET button after starting any operation. At the same time, the  mark is indicated.

### Cancelling QUIET mode

#### 1 QUIET button

Push the QUIET button once again. At the same time, the  mark on the remote controller disappears.

- The fan speed is set to AUTO. You can change it to your preferred speed.

### ⚠ CAUTION

The QUIET mode cannot be activated in the DRY operation.

### NOTE

Under certain conditions, the quiet operation may not provide adequate cooling or heating due to the feature of quietness.

## ■ Preset operation

Set your preferred operation mode for future use. The setting is memorized by the unit for future operation (except airflow direction).

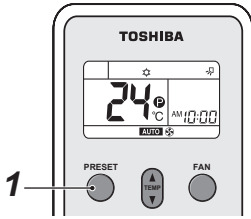

Select your preferred operation.

### 1 Push the PRESET button for 3 seconds to memorize the setting.

The  mark is displayed.

When you push this button next time, the memorized operation mode will be enabled.

## ■ Comfort sleep operation

COMFORT SLEEP mode is a OFF timer operation with automatic temperature and fan speed adjustment.

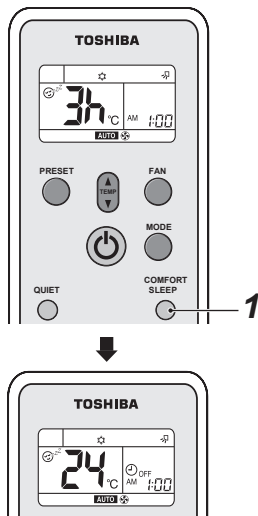

### 1 Push the COMFORT SLEEP button.

Select 1, 3, 5 or 9 hours for the OFF timer operation.

## CAUTION

- The COMFORT SLEEP mode is not enabled in the DRY or FAN ONLY operation.
- When Auto changeover control mode is selected, the air conditioner does not automatically control the room temperature.

## ■ Sleep timer operation

To start the sleep timer (OFF timer) operation

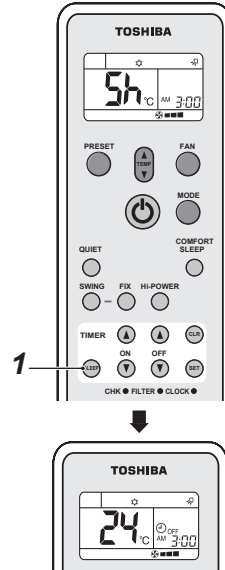

### 1 Push the SLEEP button.

Select 1, 3, 5 or 9 hours for the OFF timer operation.

# 6 Operating unit with timer

## ON timer and OFF timer

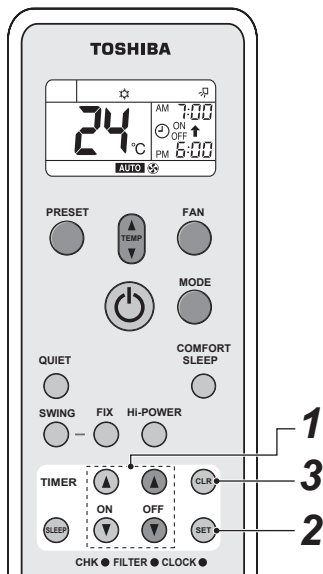

### Setting TIMER

#### 1 ON/OFF TIMER button (⏰ or ⏰)

Push the ON or OFF TIMER buttons as required.

- The previous timer setting is displayed and flashes along with ON/OFF timer display.

Set the timer to the desired time.

Each push of the TIMER button changes the time in ten minute steps.

Pushing the TIMER button continually changes the time in one hour step.

#### 2 SET button

Push the SET button to set the timer.

The timer time is indicated and the timer starts.

### Cancelling TIMER

#### 3 CLR button

Push the CLR button to cancel the timer setting.

## CAUTION

- When you select the timer operation, the remote controller automatically transmits the timer signal to the indoor unit at the specified time. Therefore, keep the remote controller in a location where it can transmit the signal to the indoor unit properly. Otherwise, the time lag of up to 15minutes will occur.
- If you do not push the SET button within 30 seconds after setting the time, the setting will be cancelled.

Once you select the timer operation mode, the settings are saved in the remote controller.

Thereafter, the air conditioner will start operating under the same conditions when you simply push the ON/OFF button of the remote controller.

If the clock display is flashing, you cannot set the timer. Follow the instructions in the section "Setting the clock" and then set the timer.

### Combined timer (Setting both ON and OFF timers simultaneously)

#### OFF timer → ON timer (Operation → Stop → Operation)

This feature is useful when you want to stop the air conditioner after you go to sleep, and start it again in the morning when you wake up or you return home.

Example:

To stop the air conditioner and start it again next morning.

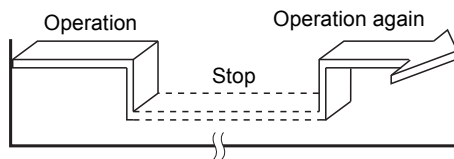

#### ▼ Setting combined TIMER

- Push the OFF TIMER button to adjust the OFF timer.
- Push the ON TIMER button to adjust the ON timer.
- Push the SET button.

## ON timer → OFF timer (Stop → Operation → Stop)



You can use this setting to start the air conditioner when you wake up and stop it when you leave the house.

Example:

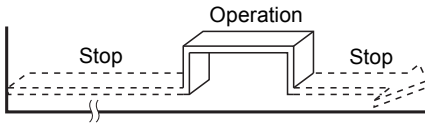
To start the air conditioner next morning and stop it.









### ▼ Setting combined TIMER



1. Push the ON TIMER  button to adjust the ON timer.
  2. Push the OFF TIMER  button to adjust the OFF timer.
  3. Push the SET  button.
- Either ON or OFF timer function which is closer to the current time, is activated first.
  - If the same time is set for both ON and OFF timers, no timer operation is performed.  
Also, the air conditioner may stop operating.

### Every day combined timer (setting both ON and OFF timer simultaneously and activate every day.)

This feature is useful when you want to use combined timer at the same time every day.

### ▼ Setting combined TIMER

1. Push the ON TIMER  button to adjust the ON timer.
2. Push the OFF TIMER  button to adjust the OFF timer.
3. Push the SET  button.
4. After step 3, an arrow mark ( or ) flashes for about 3 seconds and during this flashing, push the SET  button.

During the every day timer is activating, both arrows (, ) are indicated.

### Cancel the timer operation

Push the CLR  button.

### Clock display

During the TIMER operation (ON-OFF, OFF-ON, OFF timer) clock display is disappeared so as to show the setting time. To see the present time, push SET button briefly and the present time is displayed about 3 seconds.

# 7 Adjusting louver direction

- Never move the louver (air direction up / down adjusting plate) which is operated on the remote controller with hands except a case of cleaning the louver.
- While the air conditioner is not working, the louver (air direction adjusting plate) is closed automatically.
- During the preparation for heating, the louver is directed upward and it starts swinging after the preparation for heating is cancelled though the swing display on the remote controller shows swinging even during this period.
- The louver angle does not change immediately after the FIX button is pushed. Check the louver status, and push FIX button after a while.

## To set louver direction

Push FIX  button during operation. Louver direction changes each time you push the button.

## To start swinging

Push SWING  button on the remote controller. Louver swinging appears on the display and louver direction automatically changes up and down.

## Heating mode

Keep the louver pointed downward so that discharged hot air reaches the floor.

## Cooling / dry mode

Keep the louver pointed upward. Otherwise, dew drop may form around the discharge port and drop from the unit.

## To stop swinging

Push SWING  button once again while the louver is swinging. The louver can be stopped at a desired position.

## CAUTION

- The louver angle does not change if the FIX button is pushed during SWING operation. Stop the SWING operation before changing the louver angle.
- Do not operate the air conditioner for long hours with the airflow direction set downward during the cooling or dry operation. Otherwise, condensation may occur on the surface of the vertical airflow louver and cause dew dripping.

# 8 Mounting remote controller holder

- Direct the transmitter of the remote controller toward the signal receiving unit.  
When the signal is normally received, "Pi" sound is heard once.  
("Pi, pi" sounds are heard only when the operation has started.)
- The standard distance for signal reception is approximately 8 m vertically against the signal receiving unit.  
The distance differs a little according to the capacity of the battery or other factor.
- Be careful there is not something to block the signal between the signal receiving unit and the remote controller.
- Do not put the remote controller on the place exposed to the direct sunlight or air from the air conditioner or near the stove, etc.
- Do not drop, throw, or clean with water the remote controller.
- The signal may not be accepted in a room where the electronic instantaneous-ON type or inverter type fluorescent light is set. For details, contact the shop which you purchased the air conditioner.

## ■ To use the remote controller setting to wall

Check a signal is received correctly by pushing  START/STOP button at the position to be fixed.

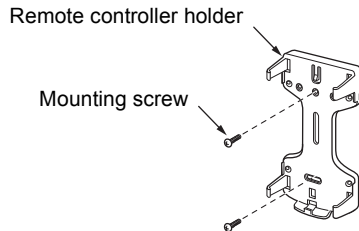

Setting method of remote controller

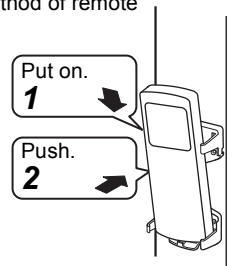

## ■ Wireless remote controller A-B selection

Using 2 wireless remote controllers for the respective air conditioners, when the 2 air conditioners are closely installed.

### Wireless remote controller B setup

1. Start the air conditioner.
2. Point the wireless remote controller at the indoor unit.
3. Push and hold **CHK** ● button on the wireless remote controller by the tip of the pencil.  
"00" will be shown on the display.
4. Push **MODE** ● button during pushing **CHK** ● .  
"B" will be shown on the display and "00" will be disappear and the air conditioner will turn OFF. The wireless remote controller B is memorized.

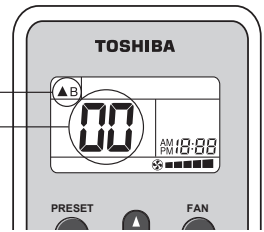

### NOTE

- Repeat above step to reset wireless remote controller to be A.
- The wireless remote controllers do not display "A".
- The factory default of the wireless remote controllers is "A".
- A-B selection can be set with signal receiving unit. For the further details, refer to the installation manual.

## 9 Operating air conditioner without remote controller

In the following cases, the air conditioner can be operate without remote controller with temporary operation button on the signal receiving unit.

- The battery in the remote controller expired.
- A trouble occurred on the remote controller.
- The remote controller has been lost.

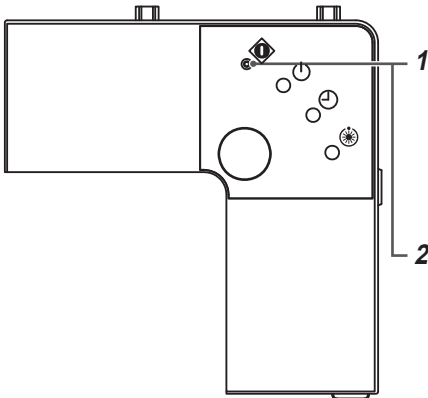

### 1 Start

- Push temporary operation button.
- The operation mode is the one last selected.  
If you want to change it, turn the power off and then on, and push the temporary operation button again.

### 2 Stop

Push temporary operation button once more.

# 10 Before asking for repair work

Check the following before asking for repair work.

Check again		
Phenomenon	Possible cause	Measures
Operation does not start even if the switch is turned on.	The air conditioner is not working or a power failure has occurred.	Push START/STOP (⏻) button on the remote controller again.
	The power switch is not turned on.	Turn on the power switch if it is off.
	The air conditioner is in the ON timer operation.	Cancel the timer operation.
	The batteries of the remote controller have been exhausted.	Replace the batteries.
	The LEDs on the signal receiving unit are not in normal state or operation mode is not correct.	Change the operation mode.
Is not the state of the display lamp "Disagreement of ❄️ (cool) and ☀️ (heat)" or "A (Automatic operation)"?		Change the operation mode.
Dual swing, cycle swing, individual louver position, or power-saving cannot be set.		This type of remote controller cannot set such functions.

Contact the dealer from whom you purchased the air conditioner.		
Phenomenon		Possible cause
The LEDs flash.		Communication error between signal receiving unit and indoor unit or address setup error when the wired remote controller is used
		Communication error between indoor unit and outdoor unit
		The protective device of the indoor unit is activated.
		The protective device of the outdoor unit is activated.
		Temperature sensor error
		The compressor of the outdoor unit is protected.
		The air conditioner is performing a test run.

LEDs on the signal receiving unit ●: OFF ❄️: Blinking (at intervals of 0.5 seconds)

LED colour ⏻: Green ⏻: Green ⚙️: Orange

Check those items. If any of those problems remains, stop the operation and turn off the power. Contact the dealer whom you purchased the air conditioner from. Convey the air conditioner model name, wireless remote controller kit model name, wireless remote controller model name, signal receiving unit model name and details of the error (including LED flashing state). Do not repair any unit by yourself as it is dangerous.

# **TOSHIBA CARRIER CORPORATION**

336 TADEHARA, FUJI-SHI, SHIZUOKA-KEN 416-8521 JAPAN

**EB01600201**