



# TOSHIBA

Leading Innovation >>>

## AIR CONDITIONER (SPLIT TYPE) Installation manual



### Outdoor Unit

Model name:

**RAV-SP404AT-E**  
**RAV-SP404ATZ-E**  
**RAV-SP404ATZG-E**  
**RAV-SP454AT-E**  
**RAV-SP454ATZ-E**  
**RAV-SP454ATZG-E**  
**RAV-SP564AT-E**  
**RAV-SP564ATZ-E**  
**RAV-SP564ATZG-E**

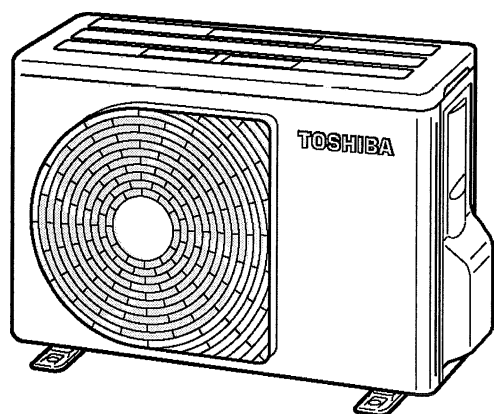

Installation manual Air conditioner (Split type)	1	English
Manuel d'installation Climatiseur (Type split)	25	Français
Installationshandbuch Klimagerät (Split-typ)	49	Deutsch
Manuale di installazione Condizionatore d'aria (Tipo split)	73	Italiano
Manual de instalación Aire acondicionado (Tipo split)	97	Español
Manual de instalação Ar condicionado (Tipo split)	121	Português
Installatiehandleiding Airconditioner (Gesplitst type)	145	Nederlands
Εγχειρίδιο εγκατάστασης Κλιματιστικό (διαίρουμένου τύπου)	169	Ελληνικά
Руководство по установке Кондиционер воздуха (сплит-система)	193	Русский
Montaj kılavuzu Klima (Split tip)	217	Türkçe

Please read this Installation Manual carefully before installing the Air Conditioner.

- This Manual describes the installation method of the outdoor unit.
- For installation of the indoor unit, follow the Installation Manual attached to the indoor unit.

## ADOPTION OF NEW REFRIGERANT

This Air Conditioner is a new type that has adopted a new refrigerant HFC (R410A) instead of the conventional refrigerant R22 in order to prevent destruction of the ozone layer.



# Contents

---

1	ACCESSORY PARTS .....	2
2	SAFETY PRECAUTIONS .....	3
3	INSTALLATION OF NEW REFRIGERANT AIR CONDITIONER .....	4
4	INSTALLATION CONDITIONS .....	7
5	REFRIGERANT PIPING .....	12
6	AIR PURGING .....	15
7	ELECTRICAL WORK .....	17
8	EARTHING .....	19
9	FINISHING .....	19
10	TEST RUN .....	19
11	FUNCTIONS TO BE IMPLEMENTED LOCALLY .....	20
12	APPLICABLE OUTDOOR UNIT CONTROL FUNCTIONS .....	21
13	ANNUAL MAINTENANCE .....	21
14	APPENDIX .....	22

# 1 ACCESSORY PARTS

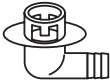
## ■ Accessory Parts

Part name	Q'ty	Shape	Usage
Installation manual	1	This manual	(Hand this directly to the customer.)
Drain nipple	1		
Waterproof rubber cap	2		

## 2 SAFETY PRECAUTIONS

- Ensure that all Local, National and International regulations are satisfied.
- Read these "SAFETY PRECAUTIONS" carefully before Installation.
- The precautions described below include important items regarding safety. Observe them without fail.
- After the installation work, perform a trial operation to check for any problem. Follow the Owner's Manual to explain to the customer how to use and maintain the unit.
- Ask the customer to keep the Installation Manual together with the Owner's Manual.

### WARNING

- **Ask an authorized dealer or qualified installation professional to install/maintain the air conditioner. Perform installation work properly according to the Installation Manual.**  
Inappropriate installation may result in water leakage, electric shock or fire.
- **Be sure to connect earth wire. (grounding work)**  
Incomplete grounding cause an electric shock.  
Do not connect ground wires to gas pipes, water pipes, lightning rods or ground wires for telephone wires.
- **Turn off the main power supply switch or breaker before attempting any electrical work and maintenance.**  
Make sure all power switches are off. Failure to do so may cause electric shock.  
Use an exclusive power circuit for the air conditioner. Use the rated voltage.
- **Connect the connecting wire correctly.**  
If the connecting wire is incorrect, electric parts may be damaged.
- **When moving the air conditioner for installation to another place, be very careful not to allow the specified refrigerant (R410A) to become mixed with any other gaseous body into the refrigeration cycle.**  
If air or any other gas mixes with the refrigerant, the gas pressure in the refrigeration cycle will become abnormally high and it may result in the pipe bursting or personal injuries.
- **Do not modify this unit by removing any of the safety guards or by by-passing any of the safety interlock switches.**
- **Do not touch the intake or aluminum fins of the outdoor unit.**  
Doing so may result in injury.
- **Tighten the flare nut with a torque wrench in the specified manner.**  
Excessive tightening of the flare nut may cause a crack in the flare nut after a long period, which may result in refrigerant leakage.
- **Install the air conditioner securely in a location where the base can sustain the weight of the unit adequately.**
- **Perform the specified installation work to guard against an earthquake.**  
If the air conditioner is not installed appropriately, accidents may occur due to the unit falling.
- **If refrigerant gas has leaked during the installation work, ventilate the room immediately.**  
If the leaked refrigerant gas comes in contact with fire, noxious gas may be generated.
- **After the installation work, confirm that refrigerant gas does not leak.**  
If refrigerant gas leaks into the room and flows near a fire source, such as a cooking range, noxious gas may be generated.
- **Electrical work must be performed by a qualified electrician in accordance with the Installation Manual. Make sure the air conditioner uses an exclusive power supply.**  
An insufficient power supply capacity or inappropriate installation may cause fire.
- **Use only the specified wiring during the unit installation. Ensure that all terminals are securely fixed, so preventing any external forces having a negative effect on the terminals.**
- **When the air conditioner cannot cool or heat a room well, contact the dealer from whom you purchased the air conditioner as refrigerant leakage is considered as the cause.**  
**In the case of repair that requires refill of refrigerant, ask service personnel about details of the repair.**  
The refrigerant used in the air conditioner is harmless.  
Generally, the refrigerant does not leak. However, if the refrigerant leaks in a room and a heater or stove burner in the room catches fire, it may generate toxic gas.  
When you ask service personnel for repairing refrigerant leakage, confirm that the leakage portion has been completely repaired.
- **Conform to the regulations of the local electric company when wiring the power supply.**  
Inappropriate grounding may cause electric shock.

- **Do not install the air conditioner in a location that may be subjected to a risk of exposure to a combustible gas.**  
If a combustible gas leaks and becomes concentrated around the unit, a fire may occur.
  - **Install the refrigerant pipe securely during the installation work before operating the air conditioner.**  
If the compressor is operated with the valve open and without the refrigerant pipe, the compressor sucks air and the refrigeration cycle is overpressurized, which may cause a burst or injury.
  - **When carrying out the pump-down work, shut down the compressor before disconnecting the refrigerant pipe.**  
Disconnecting the refrigerant pipe with the service valve left open and with the compressor still operating will cause air, etc. to be sucked in, raising the pressure inside the refrigeration cycle to an abnormally high level, and possibly resulting in rupturing, injury, etc.
- 

### CAUTION

---

- **Do not climb onto or place objects on top of the outdoor unit.**  
You may fall or the objects may fall off of the outdoor unit and result in injury.
- **Wear heavy gloves during the installation work to avoid injury.**

#### **To Disconnect the Appliance from the Main Power Supply**

- This appliance must be connected to the main power supply by means of a switch with a contact separation of at least 3 mm.
  - A 16 A installation fuse (all fuse types can be used) must be used for the power supply line of this conditioner.
- 

## 3 INSTALLATION OF NEW REFRIGERANT AIR CONDITIONER

### CAUTION

---

#### **New Refrigerant Air Conditioner Installation**

- **THIS AIR CONDITIONER ADOPTS THE NEW HFC REFRIGERANT (R410A) WHICH DOES NOT DESTROY OZONE LAYER.**

R410A refrigerant is apt to be affected by impurities such as water, oxidizing membrane, and oils because the working pressure of R410A refrigerant is approx. 1.6 times as that of refrigerant R22. Accompanied with the adoption of the new refrigerant, the refrigerant oil has also been changed. Therefore, during installation work, be sure that water, dust, former refrigerant, or refrigerant oil does not enter the new type refrigerant R410A air conditioner circuit.

To prevent mixing of refrigerant or refrigerant oil, the sizes of connecting sections of charging port on main unit and installation tools are different from those of the conventional refrigerant units. Accordingly, special tools are required for the new refrigerant (R410A) units. For connecting pipes, use new and clean piping materials with high pressure fittings made for R410A only, so that water and/or dust does not enter.

---

## ■ Required Tools/Equipment and Precautions for Use

Prepare the tools and equipment listed in the following table before starting the installation work. Newly prepared tools and equipment must be used exclusively.

### Legend

△ : Prepared newly (Use for R410A only. Do not use for refrigerant R22 or R407C etc..)

◎ : Conventional tools/equipment are available

Tools/equipment	Use	How to use tools/equipment
Gauge manifold	Vacuuming/charging refrigerant and operation check	△ Prepared newly for R410A only
Charging hose		△ Prepared newly for R410A only
Charging cylinder	Can not be used	Unusable (Use the refrigerant charging measure instead.)
Gas leak detector	Gas leak check	△ Prepared newly
Vacuum pump	Vacuum drying	Unusable
Vacuum pump with backflow prevention function	Vacuum drying	◎ R22
Flare tool	Flare machining of pipes	◎ Usable if dimensions are adjusted.
Bender	Bending pipes	◎ R22
Refrigerant recovery equipment	Refrigerant recovery	△ For R410A only
Torque wrench	Tightening flare nuts	△ Exclusive for Ø12.7 mm
Pipe cutter	Cutting pipes	◎ R22
Welding machine and nitrogen cylinder	Welding pipes	◎ R22
Refrigerant charging measure	Charging refrigerant	◎ R22

### ■ Refrigerant Piping

#### New refrigerant (R410A)

##### **When using the conventional piping**

- When using the conventional piping with no indication of applicable refrigerant types, be sure to use it with a wall thickness of 0.8 mm for  $\text{Ø}6.4$  mm and  $\text{Ø}12.7$  mm. Do not use the conventional piping kit with a wall thickness less than these thicknesses due to insufficient pressure capacity.

##### **When using general copper pipes**

- Use general copper pipes with a wall thickness of 0.8 mm for  $\text{Ø}6.4$  mm and  $\text{Ø}12.7$  mm. Do not use any copper pipes with a wall thickness less than these thicknesses.

##### **Flare nuts and flare machining**

- The flare nuts and flare machining are different from those for the conventional refrigerant. Use the flare nuts supplied with the air conditioner or those for R410A.
- Before performing flare machining, carefully read "REFRIGERANT PIPING".

# 4 INSTALLATION CONDITIONS

## ■ Before installation

Be sure to prepare to the following items before installation.

### Length of refrigerant pipe

<SP40, SP45>

Length of refrigerant pipe connected to indoor/outdoor unit	Item
5 to 20 m	Addition of refrigerant is unnecessary at the local site.
*21 to 30 m	<Addition of refrigerant> Add 20 g of refrigerant for every 1 m of piping that exceeds 20 m.

- \* Caution during addition of refrigerant  
When the total length of refrigerant piping exceeds 20 m, add 20 g/m of refrigerant up to a maximum total length of piping at 30 m. (Max. amount of additional refrigerant is 200 g.)  
Charge the refrigerant accurately. Overcharging may cause serious trouble with the compressor.
- \* Do not connect a refrigerant pipe that is shorter than **5 m**. This may cause a malfunction of the compressor or other devices.

<SP56>

Length of refrigerant pipe connected to indoor/outdoor unit	Item
5 to 20 m	Addition of refrigerant is unnecessary at the local site.
*21 to 50 m	<Addition of refrigerant> Add 20 g of refrigerant for every 1 m of piping that exceeds 20 m.

- \* Caution during addition of refrigerant  
When the total length of refrigerant piping exceeds 20 m, add 20 g/m of refrigerant up to a maximum total length of piping at 50 m. (Max. amount of additional refrigerant is 600 g.)  
Charge the refrigerant accurately. Overcharging may cause serious trouble with the compressor.
- \* Do not connect a refrigerant pipe that is shorter than **5 m**. This may cause a malfunction of the compressor or other devices.

### Airtight test

1. Before starting an airtight test, further tighten the spindle valves on the gas and liquid sides.
2. Pressurize the pipe with nitrogen gas charged from the service port to the design pressure (4.15 Mpa) to conduct an airtight test.
3. Check for gas leaks using a leak tester for the HFC refrigerant.
4. After the airtight test is completed, evacuate the nitrogen gas.

### Air purge

- To purge air, use a vacuum pump.
- Do not use refrigerant charged in the outdoor unit to purge air. (The air purge refrigerant is not contained in the outdoor unit.)

### Electrical wiring

- Be sure to fix the power wires and indoor/outdoor connecting wires with clamps so that they do not come into contact with the cabinet, etc.

### Earthing

#### **WARNING**

#### **Make sure that proper earthing is provided.**

Improper earthing may cause an electric shock. For details on how to check earthing, contact the dealer who installed the air conditioner or a professional installation company.

- Proper earthing can prevent charging of electricity on the outdoor unit surface due to the presence of a high frequency in the frequency converter (inverter) of the outdoor unit, as well as prevent electric shock. If the outdoor unit is not properly earthed, you may be exposed to an electric shock.
- **Be sure to connect the earth wire. (grounding work)**  
Incomplete grounding can cause an electric shock.  
Do not connect ground wires to gas pipes, water pipes, lightning rods or ground wires for telephone wires.

### Test Run

Turn on the leakage breaker at least 12 hours before starting a test run to protect the compressor during startup.

#### **CAUTION**

Incorrect installation work may result in a malfunction or complaints from customers.



## ■ Installation Location

### ⚠ WARNING

**Install the outdoor unit properly in a location that is durable enough to support the weight of the outdoor unit.**

Insufficient durability may cause the outdoor unit to fall, which may result in injury.

### ⚠ CAUTION

**Do not install the outdoor unit in a location that is subject to combustible gas leaks.**

Accumulation of combustible gas around the outdoor unit may cause a fire.

**Install the outdoor unit in a location that meets the following conditions after the customer's consent is obtained.**

- A well-ventilated location free from obstacles near the air inlets and air outlet
- A location that is not exposed to rain or direct sunlight
- A location that does not increase the operating noise or vibration of the outdoor unit
- A location that does not produce any drainage problems from discharged water

**Do not install the outdoor unit in the following locations.**

- A location with a saline atmosphere (coastal area) or one that is full of sulfide gas (hot-spring area) (Special maintenance is required.)
- A location subject to oil, vapor, oily smoke, or corrosive gases
- A location in which organic solvent is used
- A location where high-frequency equipment (including inverter equipment, private power generator, medical equipment, and communication equipment) is used (Installation in such a location may cause malfunction of the air conditioner, abnormal control or problems due to noise from such equipment.)
- A location in which the discharged air of the outdoor unit blows against the window of a neighboring house
- A location where the operating noise of the outdoor unit is transmitted
- When the outdoor unit is installed in an elevated position, be sure to secure its feet.
- A location in which drain water poses any problems.

### ⚠ CAUTION

1. Install the outdoor unit in a location where the discharge air is not blocked.
2. When an outdoor unit is installed in a location that is always exposed to strong winds like a coast or on the high stories of a building, secure normal fan operation by using a duct or wind shield.
3. When installing the outdoor unit in a location that is constantly exposed to strong winds such as on the upper stairs or rooftop of a building, apply the windproofing measures referred to in the following examples.

- 1) Install the unit so that its discharge port faces the wall of the building.  
Keep a distance 500 mm or more between the unit and wall surface.

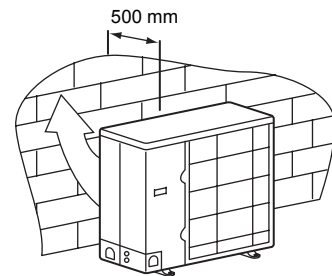

- 2) Consider the wind direction during the operational season of the air conditioner, and install the unit so that the discharge port is set at a right angle relative to the wind direction.

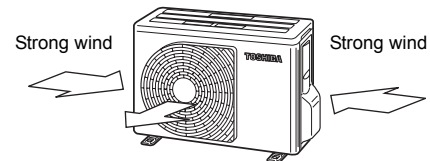

- When using an air conditioner under low outside temperature conditions (Outside temp: -5 °C or lower) in COOL mode, prepare a duct or wind shield so that it is not affected by the wind.

#### <Example>

Suction hood (Side)  
Discharge hood

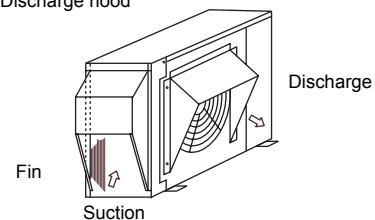

**■ Necessary Space for Installation  
(Unit: mm)**

**Obstacle at rear side**

**Upper side is free**

1. Single unit installation

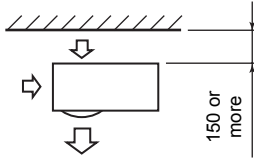

2. Obstacles on both right and left sides.

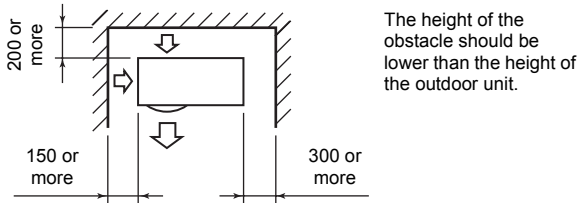

3. Serial installation of two or more units

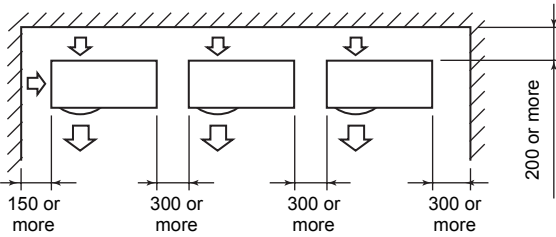

The height of the obstacle should be lower than the height of the outdoor unit.

**Obstacle also above unit**

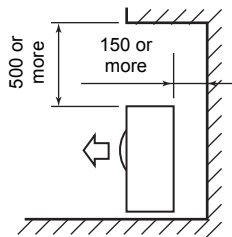

**Obstacle in front**

**Above unit is free**

1. Single unit installation

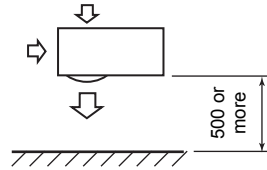

2. Serial installation of two or more units

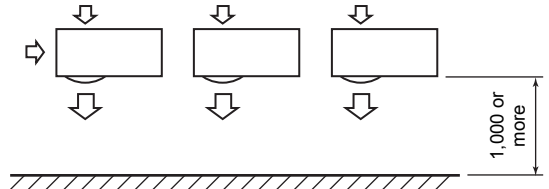

**Obstacle also at the above unit**

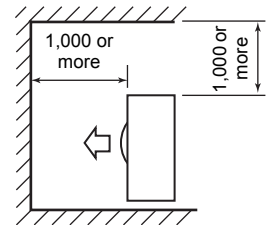

**Obstacles in both front and rear of unit**

Open above and to the right and left of the unit.

The height of an obstacle in both the front and rear of the unit, should be lower than the height of the outdoor unit.

**Standard installation**

1. Single unit installation

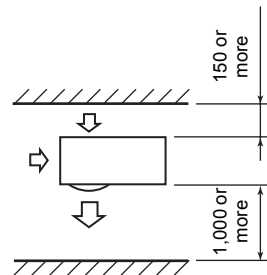

2. Serial installation of two or more units

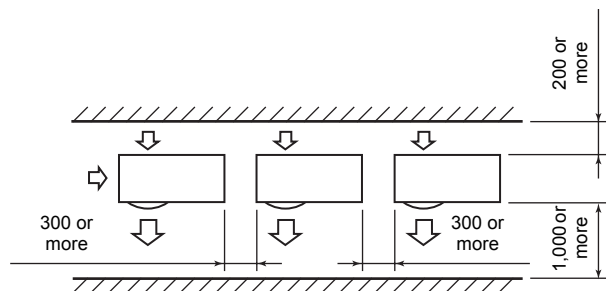

**Serial installation in front and rear**

Open above and to the right and left of the unit.  
The height of an obstacle in both the front and rear of the unit should be lower than the height of the outdoor unit.

**Standard installation**

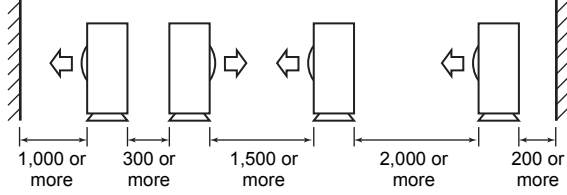

**Installation of Outdoor Unit**

- Before installation, check the strength and horizontalness of the base so that abnormal sounds do not emanate.
- According to the following base diagram, fix the base firmly with the anchor bolts.  
(Anchor bolt, nut: M10 x 4 pairs)

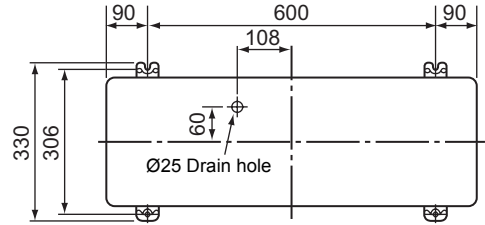

- As shown in the figure below, install the foundation and vibration-proof rubber pads to directly support the bottom surface of the fixing leg that is in contact with and underneath the bottom plate of the outdoor unit.
- \* When installing the foundation for an outdoor unit with downward piping, consider the piping work.

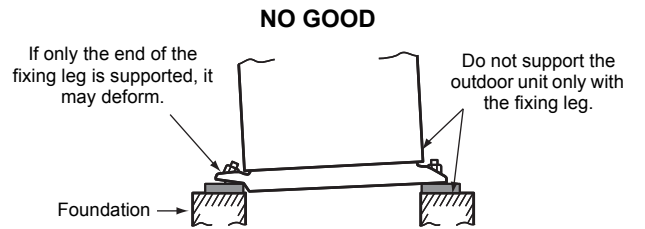
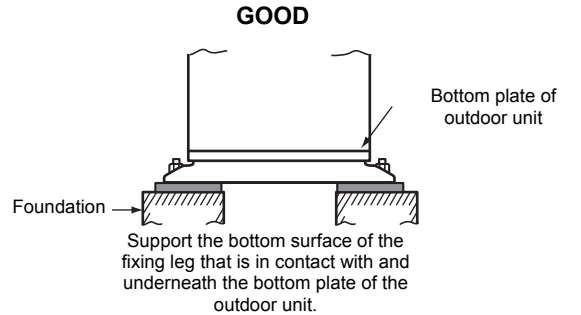
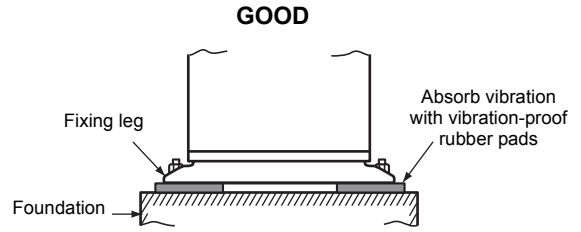

Set the out margin of the anchor bolt to 15 mm or less.

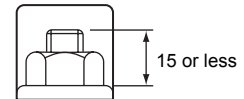

EN

- When water is to be drained through the drain hose, attach the following drain nipple and waterproof rubber cap, and use the drain hose (Inner dia.: 16 mm) sold on the market. Also seal the screws securely with silicone material, etc., to prevent water from leaking. Some conditions may cause dewing or dripping of water.
- When collectively draining discharged water completely, use a drain pan.

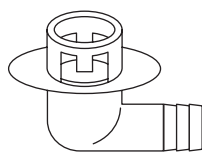

Drain nipple

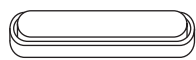

Waterproof rubber cap  
(2pcs.)

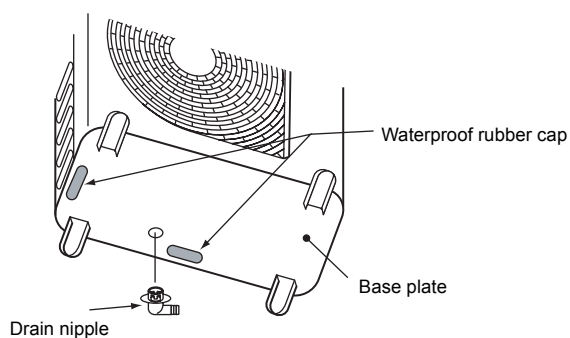

Drain nipple

### ■ For Reference

If a heating operation is to be continuously performed for a long time under the condition that the outdoor temperature is 0 °C or lower, draining defrosted water may be difficult due to the bottom plate freezing, resulting in trouble with the cabinet or fan.

It is recommended to procure an anti-freeze heater locally in order to safely install the air conditioner.

For details, contact the dealer.

# 5 REFRIGERANT PIPING

## ■ Optional Installation Parts (Locally procured)

	Parts name	Q'ty
<b>A</b>	Refrigerant piping Liquid side : Ø6.4 mm Gas side : Ø12.7 mm	One each
<b>B</b>	Pipe insulating material (polyethylene foam, 6 mm thick)	1
<b>C</b>	Putty, PVC tape	One each

## ■ Refrigerant Piping Connection

### CAUTION

#### TAKE NOTE OF THESE 4 IMPORTANT POINTS BELOW FOR PIPING WORK

1. Keep dust and moisture away from inside the connecting pipes.
2. Tightly connect the connection between pipes and the unit.
3. Evacuate the air in the connecting pipes using a VACUUM PUMP.
4. Check for gas leaks at connection points.

#### Piping connection

Liquid side	
Outer diameter	Thickness
Ø6.4 mm	0.8 mm

Gas side	
Outer diameter	Thickness
Ø12.7 mm	0.8 mm

## Flaring

1. Cut the pipe with a pipe cutter.  
Be sure to remove burrs that may cause a gas leak.
2. Insert a flare nut into the pipe, and then flare the pipe.  
Use the flare nuts supplied with the air conditioner or those for R410A.  
Insert a flare nut into the pipe, and flare the pipe.  
As the flaring sizes of R410A differ from those of refrigerant R22, the flare tools newly manufactured for R410A are recommended.  
However, the conventional tools can be used by adjusting the projection margin of the copper pipe.

#### Projection margin in flaring : B (Unit : mm)

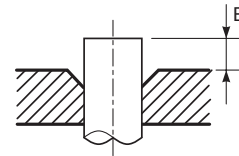

Rigid (Clutch type)

Outer dia. of copper pipe	R410A tool used	Conventional tool used
	R410A	R410A
6.4	0 to 0.5	1.0 to 1.5
12.7		

#### Flaring dia. size : A (Unit : mm)

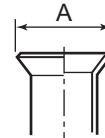

Outer dia. of copper pipe	A <sup>+0</sup> <sub>-0.4</sub>
6.4	9.9
12.7	16.6

- \* In case of flaring for R410A with the conventional flare tool, pull the tool out approx. 0.5 mm more than that for R22 to adjust it to the specified flare size.  
The copper pipe gauge is useful for adjusting the projection margin size.

### ■ Tightening of Connecting Part

1. Align the centers of the connecting pipes and fully tighten the flare nut with your fingers. Then fix the nut with a wrench as shown in the figure and tighten it with a torque wrench.

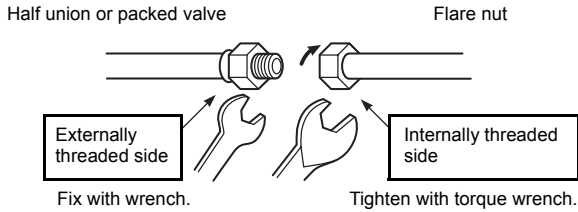

2. As shown in the figure, be sure to use two wrenches to loosen or tighten the flare nut of the valve on the gas side. If you use a single crescent, the flare nut cannot be tightened to the required tightening torque. On the other hand, use a single crescent to loosen or tighten the flare nut of the valve on the liquid side.

(Unit: N•m)

Outer dia. of copper pipe	Tightening torque
6.4 mm (dia.)	14 to 18 (1.4 to 1.8 kgf•m)
12.7 mm (dia.)	50 to 62 (5.0 to 6.2 kgf•m)

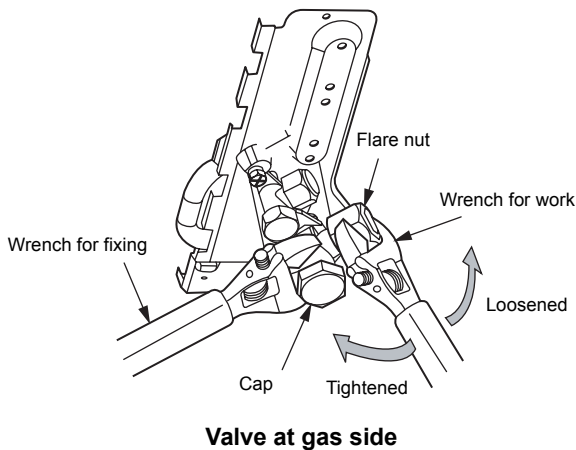

### ⚠ CAUTION

1. Do not put the crescent wrench on the cap. The valve may break.
2. If applying excessive torque, the nut may break according to some installation conditions.

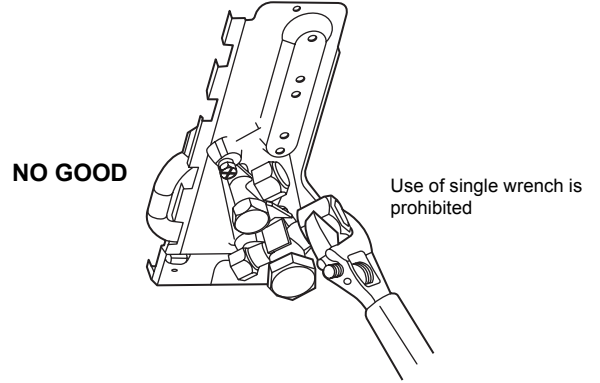

- After the installation work, be sure to check for gas leaks of the pipe connections with nitrogen.
- Pressure of R410A is higher than that of R22 (Approx. 1.6 times). Therefore, using a torque wrench, tighten the flare pipe connecting sections that connect the indoor/outdoor units at the specified tightening torque. Incomplete connections may cause not only a gas leak, but also trouble with the refrigeration cycle.

**Do not apply refrigerant oil to the flared surface.**

## ■ Refrigerant Pipe Length

### Single

Model	Allowable pipe length (m)	Height difference (Indoor-outdoor H) (m)	
	Total length L	Indoor unit: Upper	Outdoor unit: Lower
SP40, 45	30	30	30
SP56	50	30	30

Model	Pipe diameter (mm)		Number of bent portions
	Gas side	Liquid side	
SP40, 45	Ø12.7	Ø6.4	10 or less
SP56	Ø12.7	Ø6.4	10 or less

Figure of Single

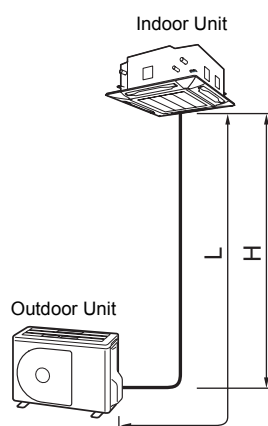

EN

# 6 AIR PURGING

## ■ Airtight test

Before starting an airtight test, further tighten the spindle valves on the gas side and liquid side.  
 Pressurize the pipe with nitrogen gas charged from the service port to the design pressure (4.15 Mpa) to conduct the airtight test. Perform gas leak checks using a leak tester for the HFC refrigerant.  
 After the airtight test is completed, evacuate the nitrogen gas.

## ■ Air Purge

With respect to the preservation of the terrestrial environment, adopt "Vacuum pump" to purge air (Evacuate air in the connecting pipes) when installing the unit.

- Do not discharge the refrigerant gas to the atmosphere to preserve the terrestrial environment.
- Use a vacuum pump to discharge the air (nitrogen, etc.) that remains in the set. If air remains, the capacity may decrease.

For the vacuum pump, be sure to use one with a backflow preventer so that the oil in the pump does not backflow into the pipe of the air conditioner when the pump stops.  
 (If oil in the vacuum pump is put in an air conditioner including R410A, it may cause trouble with the refrigeration cycle.)

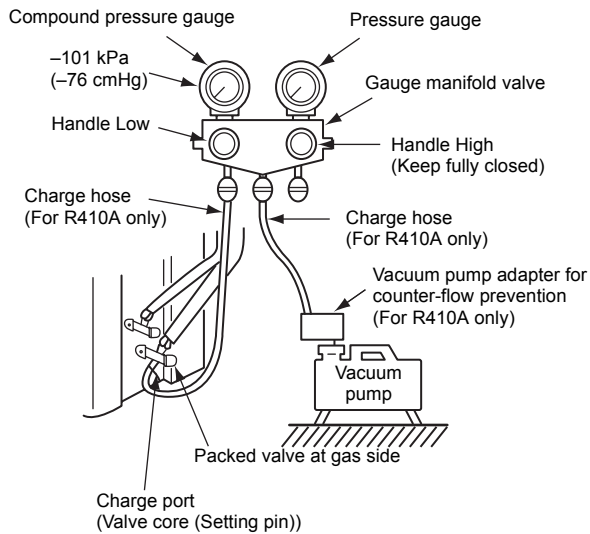

## Vacuum pump

- As shown in the figure, connect the charge hose after the manifold valve is closed completely.
- ↓
- Attach the connecting port of the charge hose with a projection to push the valve core (setting pin) to the charge port of the set.
- ↓
- Open Handle Low fully.
- ↓
- Turn ON the vacuum pump (\*1)
- ↓
- Loosen the flare nut of the packed valve (Gas side) a little to check that the air passes through. (\*2)
- ↓
- Retighten the flare nut.
- ↓
- Execute vacuuming until the compound pressure gauge indicates  $-101 \text{ kPa}$  ( $-76 \text{ cmHg}$ ). (\*1)
- ↓
- Close Handle Low completely.
- ↓
- Turn OFF the vacuum pump.
- ↓
- Leave the vacuum pump as it is for 1 or 2 minutes, and check that the indicator of the compound pressure gauge does not return.
- ↓
- Open the valve stem or valve handle fully. (First, at liquid side, then gas side)
- ↓
- Disconnect the charge hose from the charge port.
- ↓
- Tighten the valve and caps of the charge port securely.

\*1 Use the vacuum pump, vacuum pump adapter, and gauge manifold correctly referring to the manuals supplied with each tool before using them.  
 Check that the vacuum pump oil is filled up to the specified line of the oil gauge.

\*2 When air is not charged, check again whether the connecting port of the discharge hose, which has a projection to push the valve core, is firmly connected to the charge port.



### ■ How to open the valve

Open or close the valve.

#### Liquid side, gas side

Open the valve with a 4 mm hexagon wrench.  
[Hexagonal wrench is required.]

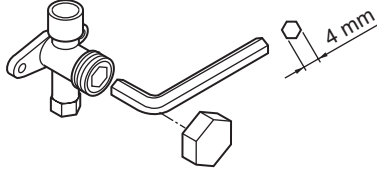

#### Valve handling precautions

- Open the valve stem until it strikes the stopper. It is unnecessary to apply further force.
- Securely tighten the cap with a torque wrench.

#### Cap tightening torque

Valve size	Ø6.4 mm	14 to 18 N•m (1.4 to 1.8 kgf•m)
	Ø12.7 mm	33 to 42 N•m (3.3 to 4.2 kgf•m)
Charge port		14 to 18 N•m (1.4 to 1.8 kgf•m)

### ■ Replenishing refrigerant

This model is a 20 m chargeless type that does not need to have its refrigerant replenished for refrigerant pipes up to 20 m. When a refrigerant pipe longer than 20 m is used, add the specified amount of refrigerant.

#### Refrigerant replenishing procedure

1. After vacuuming the refrigerant pipe, close the valves and then charge the refrigerant while the air conditioner is not working.
2. When the refrigerant cannot be charged to the specified amount, charge the required amount of refrigerant from the charge port of the valve on the gas side during cooling.

#### Requirement for replenishing refrigerant

Replenish liquid refrigerant.

When gaseous refrigerant is replenished, the refrigerant composition varies, which disables normal operation.

#### Adding additional refrigerant

SP40, 45	SP56
21~30 m: L	21~50 m: L
20 g × (L-20)	20 g × (L-20)

- L: Pipe length
- The refrigerant need not be reduced for a 20 meter (or less) refrigerant pipe.

# 7 ELECTRICAL WORK

1. Remove valve cover screw.
2. Pull the valve cover downward to remove it.

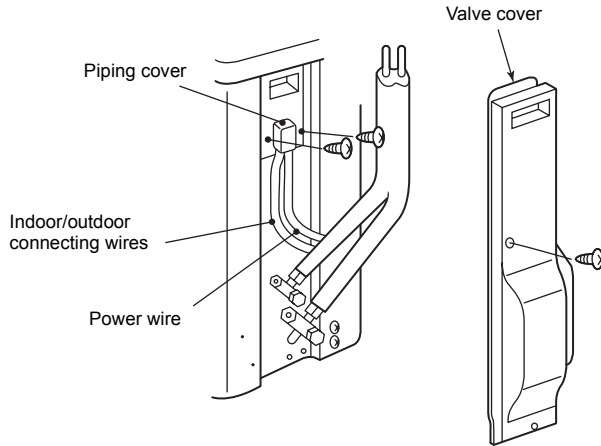

## ■ Wiring between Indoor Unit and Outdoor Unit

The dashed lines show on-site wiring.

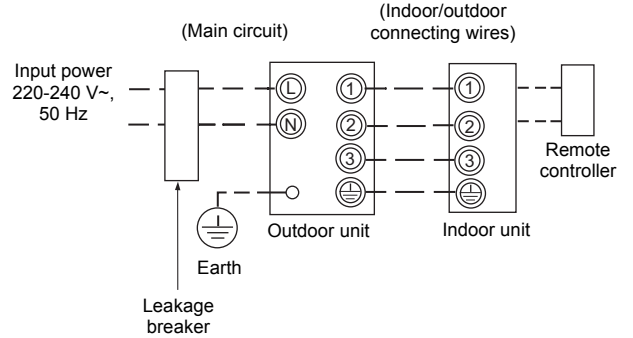

- Connect the indoor/outdoor connecting wires to the identical terminal numbers on the terminal block of each unit.  
Incorrect connection may cause a failure.

For the air conditioner, connect a power wire with the following specifications.

Model RAV-	SP40, SP45, SP56
<b>Power supply</b>	220-240 V~, 50 Hz
<b>Maximum running current</b>	15 A
<b>Installation fuse rating</b>	16 A (all types can be used)
<b>Power wire</b>	H07 RN-F or 60245 IEC 66 (2.5 mm <sup>2</sup> or more)
<b>Indoor/outdoor connecting wires</b>	H07 RN-F or 60245 IEC 66 (1.5 mm <sup>2</sup> or more)

### ⚠ CAUTION

- Wrong wiring may cause a burn-out of some electrical parts.
- Be sure to use the cord clamps attached to the product.
- Do not damage or scratch the conductive core or inner insulator of the power and inter-connecting wires when peeling them.
- Use the power and Inter-connecting wires with specified thicknesses, specified types and protective devices required.

**How to wire**

1. Connect the connecting wire to the terminal as identified with their respective numbers on the terminal block of the indoor and outdoor units.  
H07 RN-F or 60245 IEC 66 (1.5 mm<sup>2</sup> or more)
2. When connecting the connecting wire to the outdoor unit terminal, prevent water from coming into the outdoor unit.
3. Insulate the unsheathed cords (conductors) with electrical insulation tape. Process them so that they do not touch any electrical or metal parts.
4. For interconnecting wires, do not use a wire joined to another on the way.  
Use wires long enough to cover the entire length.

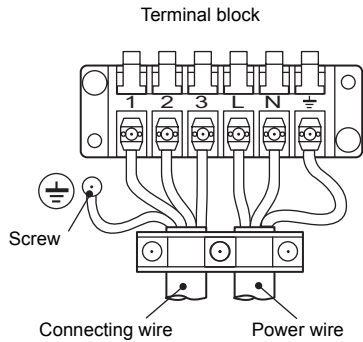

**CAUTION**

- An installation fuse must be used for the power supply line of this air conditioner.
- Incorrect/incomplete wiring may lead to an electrical fire or smoke.
- Prepare an exclusive power supply for the air conditioner.
- This product can be connected to the mains power.  
Fixed wire connections :  
A switch that disconnects all poles and has a contact separation of at least 3 mm must be incorporated in the fixed wiring.

**Stripping length power cord and connecting wire**

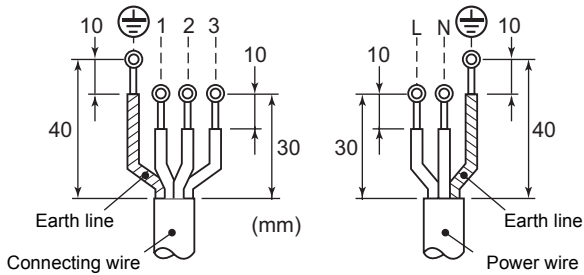

EN

## 8 EARTHING

### WARNING

- 
- **Be sure to connect the earth wire. (grounding work)**  
Incomplete grounding may cause an electric shock.
- 

Connect the earth line properly following applicable technical standards.

Connecting the earth line is essential to preventing electric shock and to reducing noise and electrical charges on the outdoor unit surface due to the high-frequency wave generated by the frequency converter (inverter) in the outdoor unit.

If you touch the charged outdoor unit without an earth line, you may experience an electric shock.

## 9 FINISHING

After the refrigerant pipe, inter-unit wires, and drain pipe have been connected, cover them with finishing tape and clamp them to the wall with off-the-shelf support brackets or their equivalent.

Keep the power wires and indoor/outdoor connecting wires off the valve on the gas side or pipes that have no heat insulator.

## 10 TEST RUN

- **Turn on the leakage breaker at least 12 hours before starting a test run to protect the compressor during startup.**  
To protect the compressor, power is supplied from the 220-240 VAC input to the unit to preheat the compressor.
- **Check the following before starting a test run:**
  - **That all pipes are connected securely without leaks.**
  - **That the valve is open.**  
If the compressor is operated with the valve closed, the outdoor unit will become overpressurized, which may damage the compressor or other components.  
If there is a leak at a connection, air can be sucked in and the internal pressure further increases, which may cause a burst or injury.
- Operate the air conditioner in the correct procedure as specified in the Owner's Manual.

# 11 FUNCTIONS TO BE IMPLEMENTED LOCALLY

## ■ Handling Existing Pipe

When using the existing pipe, carefully check for the following:

- Wall thickness (within the specified range)
- Scratches and dents
- Water, oil, dirt, or dust in the pipe
- Flare looseness and leakage from welds
- Deterioration of copper pipe and heat insulator

### Cautions for using existing pipe

- Do not reuse a flare nut to prevent gas leaks. Replace it with the supplied flare nut and then process it to a flare.
- Blow nitrogen gas or use an appropriate means to keep the inside of the pipe clean. If discolored oil or much residue is discharged, wash the pipe.
- Check welds, if any, on the pipe for gas leaks.

When the pipe corresponds to any of the following, do not use it. Install a new pipe instead.

- The pipe has been opened (disconnected from indoor unit or outdoor unit) for a long period.
- The pipe has been connected to an outdoor unit that does not use refrigerant R22, R410A or R407C.
- The existing pipe must have a wall thickness equal to or larger than the following thicknesses.

Reference outside diameter (mm)	Wall thickness (mm)
Ø6.4	0.8
Ø12.7	0.8

- Do not use any pipe with a wall thickness less than these thicknesses due to insufficient pressure capacity.

## ■ Recovering Refrigerant

- When recovering refrigerant during reinstatement of the indoor or outdoor unit, etc., use the refrigerant recovery switch on the terminal block of the outdoor unit.

### Procedure

1. Start cooling operation for a while, and then stop the operation.
2. Turn on the power supply.
3. Using the remote controller, set the indoor unit to FAN operation.
4. Push the refrigerant recovery switch for 2 seconds or more on the terminal block of the outdoor unit, after which the forced cooling operation will begin (Max. 10 minutes). Recover refrigerant by handling the valve.
5. After recovering the refrigerant, push the refrigerant recovery switch while closing the valve. The operation will stop.
6. Turn off the power supply.

### **⚠ DANGER**

Be careful of electric shock because the P.C. board has an electrical current running through it.

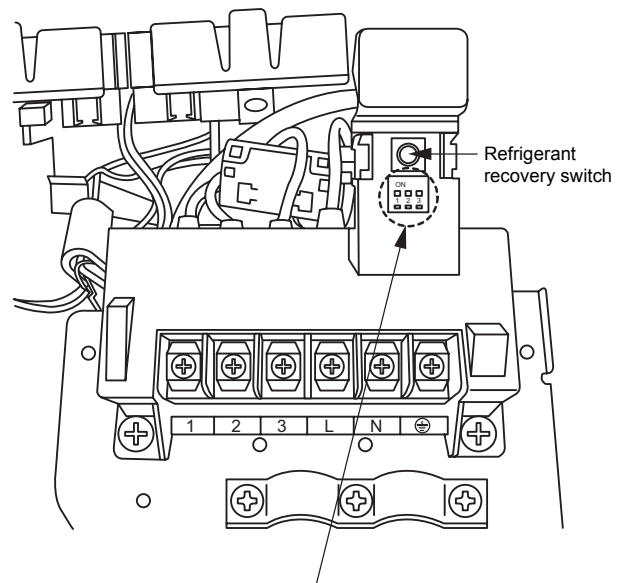

### **⚠ WARNING**

These switches are used for service/maintenance and should not be operated (the air conditioner may not operate properly).

## 12 APPLICABLE OUTDOOR UNIT CONTROL FUNCTIONS

You can use the following functions by attaching the “Application control kit” (TCB-PCOS1E2) sold separately.

### Demand control function

- Cooling/heating capacity of the outdoor unit is saved by receiving/converting external demand signals, according to temporary peak-cut conditions.
- Capacity savings can be adjusted to three steps: 75%, 50%, and operation stop.

### Night operation control (Sound reduction) function

In order to reduce noise levels at night, if incorporating this control with a commercially available timer, the outdoor operating sound level will be reduced by approx. 5 dB during cooling operation.

### Compressor operation output function

Checks the compressor operation time for maintenance etc.

## 13 ANNUAL MAINTENANCE

- For an air conditioning system that is operated on a regular basis, cleaning and maintenance of the indoor/outdoor units are strongly recommended.  
As a general rule, if an indoor unit is operated for about 8 hours daily, the indoor/outdoor units will need to be cleaned at least once every 3 months. This cleaning and maintenance should be carried out by a qualified service person.  
Failure to clean the indoor/outdoor units regularly will result in poor performance, icing, water leaking and even compressor failure.

# 14 APPENDIX

Work instructions:

The existing R22 and R407C piping can be reused for our digital inverter R410A product installations.

**NOTE**

Confirming the existence of scratches or dents on the existing pipes and confirming the reliability of the pipe strength are conventionally referred to the local site.  
**If the specified conditions can be cleared, it is possible to update existing R22 and R407C pipes to those for R410A models.**

**Basic conditions needed to reuse existing pipes**

Check and observe the presence of three conditions in the refrigerant piping works.

1. **Dry** (There is no moisture inside of the pipes.)
2. **Clean** (There is no dust inside of the pipes.)
3. **Tight** (There are no refrigerant leaks.)

**Restrictions for use of existing pipes**

**In the following cases, the existing pipes should not be reused as they are. Clean the existing pipes or exchange them with new pipes.**

1. When a scratch or dent is heavy, be sure to use new pipes for the refrigerant piping works.
2. When the existing pipe thickness is thinner than the specified "Pipe diameter and thickness," be sure to use new pipes for the refrigerant piping works.
  - The operating pressure of R410A is high (1.6 times that of R22 and R407C). If there is a scratch or dent on the pipe or a thinner pipe is used, the pressure strength may be inadequate, which may cause the pipe to break in the worst case.

\* **Pipe diameter and thickness (mm)**

Pipe outer diameter		Ø6.4	Ø9.5	Ø12.7	Ø15.9	Ø19.0
Thickness	R410A					
	R22 (R407C)	0.8	0.8	0.8	1.0	1.0

- In case the pipe diameter is Ø12.7 mm or less and the thickness is less than 0.7 mm, be sure to use new pipes for the refrigerant piping works.
3. When the outdoor unit was left with the pipes disconnected, or the gas leaked from the pipes and the pipes were not repaired and refilled.
    - There is the possibility of rain water or air, including moisture, entering the pipe.
  4. When refrigerant cannot be recovered using a refrigerant recovery unit.
    - There is the possibility that a large quantity of dirty oil or moisture remains inside the pipes.
  5. When a commercially available dryer is attached to the existing pipes.
    - There is the possibility that copper green rust has been generated.

6. When the existing air conditioner is removed after refrigerant has been recovered.
  - Check if the oil is judged to be clearly different from normal oil.
    - The refrigerator oil is copper rust green in color: There is the possibility that moisture has mixed with the oil and rust has been generated inside the pipe.
    - There is discolored oil, a large quantity of residue, or a bad smell.
    - A large quantity of shiny metal dust or other wear residue can be seen in the refrigerant oil.
7. When the air conditioner has a history of the compressor failing and being replaced.
  - When discolored oil, a large quantity of residue, shiny metal dust, or other wear residue or mixture of foreign matter is observed, trouble will occur.
8. When temporary installation and removal of the air conditioner are repeated such as when leased etc.
9. If the type of refrigerator oil of the existing air conditioner is other than the following oil (Mineral oil), Suniso, Freol-S, MS (Synthetic oil), alkyl benzene (HAB, Barrel-freeze), ester series, PVE only of ether series.
  - The winding-insulation of the compressor may deteriorate.

**NOTE**

The above descriptions are results have been confirmed by our company and represent our views on our air conditioners, but do not guarantee the use of the existing pipes of air conditioners that have adopted R410A in other companies.

**Curing of pipes**

When removing and opening the indoor or outdoor unit for a long time, cure the pipes as follows:

- Otherwise rust may be generated when moisture or foreign matter due to condensation enters the pipes.
- The rust cannot be removed by cleaning, and new pipes are necessary.

Placement location	Term	Curing manner
Outdoors	1 month or more	Pinching
	Less than 1 month	Pinching or taping
Indoors	Every time	

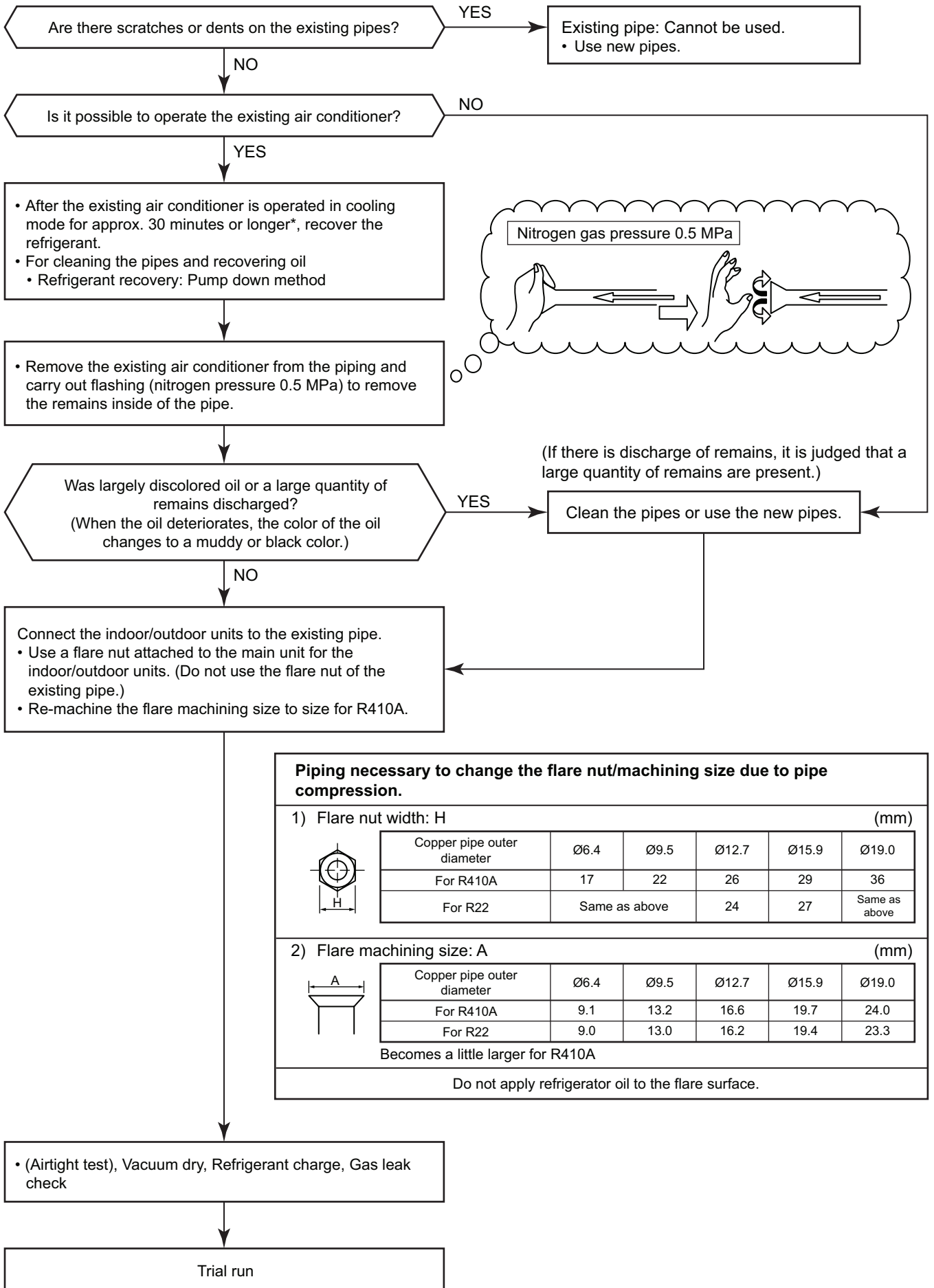

**Piping necessary to change the flare nut/machining size due to pipe compression.**

1) Flare nut width: H (mm)

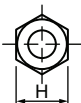
	Copper pipe outer diameter	Ø6.4	Ø9.5	Ø12.7	Ø15.9	Ø19.0
	For R410A	17	22	26	29	36
	For R22	Same as above		24	27	Same as above

2) Flare machining size: A (mm)

	Copper pipe outer diameter	Ø6.4	Ø9.5	Ø12.7	Ø15.9	Ø19.0
	For R410A	9.1	13.2	16.6	19.7	24.0
	For R22	9.0	13.0	16.2	19.4	23.3

Becomes a little larger for R410A

Do not apply refrigerator oil to the flare surface.



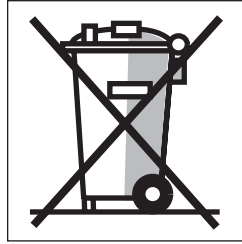

**IMPORTANT INFORMATION AND WARNING:**

**READ BEFORE INSTALLING THE UNIT. KEEP IN A SAFE PLACE. THE INFORMATION IN THIS BOOKLET IS NEEDED FOR END OF LIFE, DISPOSAL OR REUSE OF THE UNIT.**

- We are very sensitive to environment and welcome the 2002/96/EC Directive WEEE (Waste Electrical and Electronic Equipment).
- This product is compliant with EU directive 2002/96/EC. It must be collected separately after its use is completed, and cannot be disposed of as unsorted municipal waste.
- The objectives of EU directive 2002/96/EC are to tackle the fast increasing waste stream of electrical and electronic equipment, increase recycling of electric & electronic equipment ("EEE"), and to limit the total quantity of waste EEE ("WEEE") going to final disposal.
- The crossed-out wheeled bin symbol  that is affixed to the product means that this product falls under the Directive.
- The user is responsible for returning the product to the appropriate collection facility, as specified by your municipality or the distributor. In case of a new product installation, it may be possible to have the distributor pick up old WEEE directly.
- The producer, importer and distributor of the product are responsible for collection and treatment of waste, either directly or through a collective system.  
The list of our distributor in each country is shown below.
- In case of a violation of the Directive, sanctions are set in each country.
- We are in general following the "CECED interpretation," and consider the WEEE applicable to Portable units, Dehumidifiers, WRACs (Window Room Air Conditioners), Split Systems up to 12 kW, plug in refrigerators and freezers.
- Nevertheless, there may be differences among member state laws. In case country laws exclude some products from WEEE scope, country law must be followed, and WEEE obligations do not have to be followed for products that fall out of country law scope.
- This directive does not apply to products sold outside European Community. In case the product is sold outside the EU, WEEE obligations do not have to be followed, while compliance with local regulations must be ensured.
- For additional information, please contact the municipal facility, the shop/dealer/installer that sold the product, or the producer.

❶ Country

❷ Name of Company responsible for WEEE.

❶	❷
Austria	AIRCOND, Klimaanlagen Handelsgesellschaft m.b.H Petesgasse 45, A-8010 Graz Austria
Belgium	DOLPHIN NV, Fotografi elaan 12, B-2610, Antwerpen Belgium
Cyprus	Carrier Hellas Airconditioning S.A.- 4g Andersen street- 11525 Athens, Greece
Denmark	GIDEX A/S, Korshøj 10, 3600 Frederikssund, Denmark
Estonia	Carrier OY Linnavuorentie 28A 00950 Helsinki, Finland
Finland	Carrier OY Linnavuorentie 28A 00950 Helsinki, Finland
France	Carrier S.A. Route de Thil BP 49 01122 Montiel Cedex France
Germany	Carrier GmbH & Co. KG Edisonstrasse 2 85716 Unterschleissheim
Greece	Carrier Hellas Airconditioning S.A.- 4g Andersen street- 11525 Athens, Greece
Holland	INTERCOOL Technics BV Nikkelstraat 39, Postbus 76 2980 AB Ridderkerk Netherlands

❶	❷
Ireland	GT Phelan Unit 30 Southern Cross Business Park Bray Co Wicklow, Ireland
Italy	Carrier SpA Via R. Sanzio, 9 20058 Villasanta (Milano), Italy
Latvia	Carrier OY Linnavuorentie 28A 00950 Helsinki, Finland
Lithuania	Carrier OY Linnavuorentie 28A 00950 Helsinki, Finland
Luxembourg	DOLPHIN NV Fotografi elaan 12, B-2610, Antwerpen Belgium
Malta	CUTRICO Services Ltd, Cutrico Building Psala Street, Sta Venea HMR 16, Malta
Norway	Carrier AB - P.O.BOX 8946- Arods Industrivag 32. S-402 73 Gothenburg, Sweden
Poland	Carrier Polska Sp. Z.o.o. Postepu 14 02-676 Warsaw Poland
Portugal	Carrier Portugal - AR Condicionado LDA Avenida do Forte, Nr. 3 Editi cio Suecia I,Piso 1 Camaxide 2794-043 Portugal

❶	❷
UK	Toshiba Carrier UK Ltd Porsham Close, Belliver Ind. Est. Plymouth, Devon, PL6 7DB
Czech Republic	AIRCOND, , Klimaanlagen Handelsgesellschaft m.b.H Petersgasse 45, A-8010 Graz Austria
Slovakia	AIRCOND, , Klimaanlagen Handelsgesellschaft m.b.H Petersgasse 45, A-8010 Graz Austria
Slovenia	AIRCOND, , Klimaanlagen Handelsgesellschaft m.b.H, Petersgasse 45, A-8010 Graz Austria
Spain	Carrier Espana S.L. - Paseo Castellana 36-38, 28046 Madrid
Sweden	Carrier AB - P.O.BOX 8946- Arods Industrivag 32 . S-402 73 Gothenburg
Hungary	AIRCOND, Klimaanlagen Handelsgesellschaft m.b.H Petersgasse 45, A-8010 Graz Austria

The manufacturer reserves the right to change any product specifications without notice.

