

Cassette Type Series

Slim 1 Way cassette

2 Way cassette

4 Way cassette

Air Conditioner user manual

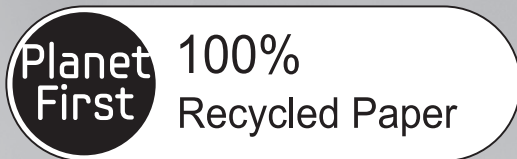

This manual is made with 100% recycled paper.



imagine the possibilities

Thank you for purchasing this Samsung product.
To receive more complete service, please
register your product at

www.samsung.com/register

(EN) (ES) (FR) (IT) (PT) (DE) (EL) (NL) (PL) (HU) (RU) DB68-03568A(1)



features of your new air conditioner

- **Cool Summer Offer**

On those hot sweltering summer days and long restless nights, there is no better escape from the heat than the cool comforts of home. Your new air conditioner brings an end to exhausting hot summer days and lets you rest. This summer, beat the heat with your own air conditioner.

- **Cost Efficient System**

Your new air conditioner not only provides maximum cooling power in the summer, but can also be an efficient heating method in the winter with the advanced “Heat pump” system. This technology is up to 300% more efficient than electrical heating, so you can further reduce its running cost. Now, meet year-round needs with one air conditioner.

- **A Look for Everywhere**

The elegant and harmonious design gives priority to the esthetics of your space and complements any of your existing interior décor. With its soft color and rounded-edge shape, the new air conditioner adds class to any room. Enjoy what your air conditioner offers both functionally and esthetically.

- **Compact and easy-to-use Cassette type**

Designed to be installed into most types of suspended ceiling, the cassette type air conditioner is ideal for business and commercial accommodations. Fresh cool/warm air can be provided through the controllable 1, 2 or 4 sides of the unit. All functions of the air conditioner will be controlled easily via a remote control.



For easy future reference write the model and serial number down. You will find your model number on the right side of the air conditioner.

Model # _____

Serial # _____

safety information



To prevent electric shock, disconnect the power before servicing, cleaning, and installing the unit.

SAFETY INFORMATION









Before using your new air conditioner, please read this manual thoroughly to ensure that you know how to safely and efficiently operate the extensive features and functions of your new appliance.

Because the following operating instructions cover various models, the characteristics of your air conditioner may differ slightly from those described in this manual. If you have questions, call your nearest contact center or find help and information online at www.samsung.com.

What the icons and signs in this user manual mean:

 WARNING	Risk of death or serious personal injury.
 CAUTION	Potential risk of personal injury or material damage.
 CAUTION	To reduce the risk of fire, explosion, electric shock, or personal injury when using your air conditioner, follow these basic safety instructions:

safety information

	Do NOT attempt.
	Do NOT disassemble.
	Do NOT touch.
	Follow directions carefully.
	Unplug the power plug from the wall socket.
	Make sure the machine is grounded to prevent electric shock.
	Call the contact center for help.
	Recommended instructions or useful information for use.

These warning signs are here to prevent injury to you and others.

Please follow them carefully.

After reading this section, keep it in a safe place for future reference.



SEVERE WARNING SIGNS

 Do not place the air conditioner near hazardous substances or equipment that releases free flames to avoid fire, explosions or injuries.

- Potential risk of fire hazard or explosion.

Do not block or place items in front of the air conditioner. Do not step, hang onto, or place heavy items on the air conditioner.

- Potential risk of personal injury.

Do not install the outdoor unit at an unstable place or elevated surface where there is potential risk of falling.

- If the outdoor unit falls, it may cause personal injury or loss of property.

Any changes or modifications performed not following by the installation manual, failure or damage may occur on the condition. In this case, user will be responsible for all the repair expenses.

If any gas or impurities other than R-410A refrigerant come into the refrigerant pipe, serious problem may occur and it may cause injury.

Do not spray flammable gases such as insecticide near the air conditioner.

- Potential risk of electric shock, fire or unit malfunction.

Do not insert anything such as fingers or branches into the air conditioner vents.

- Keep children away from the air conditioner.
Potential risk of personal injury.

Do not cut the power plug and connect to a different power cable.

Never attempt to lengthen the power cable.

- Potential risk of fire or electric shock.

Do not yank the power cable and touch the power plug with hands.

- Potential risk of fire or electric shock.

safety information



SEVERE WARNING SIGNS

 **Never use a damaged power plug, power cable, or loosened power receptacle.**

- Potential risk of fire or electric shock.

The electric work must be done by qualified service technician in accordance with the national wiring regulations with rated cables.

- If the capacity of the power cable is insufficient or electric work have not done properly, electric shock or fire may occur.

You should connect the power cable into the power cable terminal and fasten it with a clamp.

 **Do not connect the air conditioner with heating apparatus or attempt to disassemble, remodel or repair it by yourself.**

- Potential risk of malfunction, electric shock or fire. If repairs are needed, consult the contact center.

Consult the place of purchase or a contact center to disassemble or reinstall the air conditioner.

- Potential risk of unit malfunction, water leakage, electric shock, or fire.

★ Consult the place of purchase or contact center to install the air conditioner.

- Improper installation carries a risk of unit malfunction, water leakage, electric shock or fire.
- If installing in specialty areas, such as a factory complex or saline coastal area, consult the place of purchase or contact center for specific installation details.

Install the air conditioner with the support bracket securely fastened to use for an extended period of time.

- If the air conditioner falls, it may cause personal injury or loss of property.

If the indoor unit gets wet, turn the power off immediately and call your nearest contact center.

- Potential risk of fire or electric shock.

Install an exclusive circuit breaker and short-circuit breaker for the air conditioner.

- Potential risk of electric shock or fire.

If the power cable is damaged, the manufacturer or a qualified service technician must replace it.

Always make sure that the power supply is compliant with current safety standards. Always install the air conditioner in compliance with current local safety standards.

Verify that the voltage and frequency of the power supply comply with the specifications and that the installed power is sufficient to ensure the operation of any other domestic appliance connected to the same electric lines.

safety information



SEVERE WARNING SIGNS

- ★** The air conditioner must be installed in accordance with national wiring regulations and safety regulations wherever applicable.

Install the supplied cables firmly. Fix them securely so that external force is not exerted to the terminal block.

- If the connection is loose, heat may generate and cause electric shock or fire.

Use a rated circuit breaker only.

- Never use steel wires or copper wires as a circuit breaker. It may cause fire or unit malfunction.

Use an exclusive power source for the air conditioner.

- Potential risk of electric shock or fire.

Do not put undue stress or place heavy object on the power cable.

Do not bend the power cable excessively.

- Potential risk of fire or electric shock.

Always verify that electric connections (cable entry, section of leads, protections...) are compliant with the electric specifications and with the instructions provided in the wiring scheme.

Always verify that all connections comply with the standards applicable to the installation of air conditioners.



Use a receptacle that has a ground terminal. The receptacle must be used exclusively for the air conditioner.

- Improper electrical grounding may cause electric shock or fire.

Be sure to ground the unit. Do not connect the ground wire to gas or water pipes, lighting rods, or telephone grounding lines.

- If the unit is not properly grounded, electric shock may result.

Always verify that a suitable grounding connection is available.



Disconnect the air conditioner from power supply before it is repaired or disassembled.



CAUTION SIGNS



Connect the refrigerant tubes first then the electrical lines, when installing the unit.

Always disassemble the electric lines before the refrigerant tubes.

Verify that the air conditioner is connected to the power supply in accordance with the instructions provided in the wiring diagram included in the manual.

The manufacturer shall not be responsible for damage originating from unauthorized changes or the improper connection of electric and hydraulic lines.

safety information



CAUTION SIGNS

-  **Failure to comply with these instructions or to comply with the requirements set forth in the “Operating limits” table, included in the manual, and shall immediately invalidate the warranty.**

Ensure no water gets into the air conditioner.

- Potential risk or electric shock.

Turn off the air conditioner using the provided remote control or control accessory (if provided). Do not unplug to turn off the unit (unless there is an immediate danger).

Do not open the front grille during operation.

- Potential risk of electric shock or unit malfunction.

Cool air should not flow directly towards people, pets, and plants.

- It is harmful to your health, pets, and plants.

Do not run the air conditioner for an extended period of time in a room with the door closed or with babies, elderly or disabled people.

- Open the door or windows to ventilate your room at least once an hour to prevent oxygen shortage.

Do not drink drain water coming out of the air conditioner.

- Potential risk of health hazard.

Do not expose the dust filter to direct sunlight while drying.

- Strong direct sunlight may deform the dust filter.

Do not allow children to climb on the air conditioner.

Use only rated accessories and install the air conditioner with rated equipments.

- If you do not use the rated accessories, the air conditioner may drop from its place, water may leak or electric shock or fire may occur. safety information

Do not use the air conditioner as a cooling precision instrument for food, pets, plants, cosmetics or machinery.

Do not give excessive shock to the air conditioner.

- Potential risk of fire or unit malfunction.

Do not spray water directly on the air conditioner or use benzene, thinner or alcohol to clean the surface of the unit.

- Potential risk of electric shock or fire.
- Potential risk of damage to the air conditioner.

Do not place any objects, especially containers with liquid.



Do not touch the pipe connected to the air conditioner.



This appliance should be installed according to the provided installation manual.

Install the shortest possible length of pipe.

- If the length of pipe gets unnecessarily long, the life of air conditioner can be shorten and become inefficient.

safety information



CAUTION SIGNS

- ★ **Install the power cable and communication cable of the indoor and outdoor unit at least 1 m away from the electric appliance.**

Install the indoor unit away from lighting apparatus using the ballast.

- If you use the wireless remote control, reception error may occur due to the ballast of the lighting apparatus.

For maximum safety, installers should always carefully read the following warnings.

Do not install the air conditioner in following places.

- Place where there is mineral oil or arsenic acid.
- Resin parts flame and the accessories may drop or water may leak. The capacity of the heat exchanger may reduce or the air conditioner may be out of order.
- The place where corrosive gas such as sulfurous acid gas generates from the vent pipe or air outlet.
- The copper pipe or connection pipe may corrode and refrigerant may leak.
- The place where there is a machine that generates electromagnetic waves.
The air conditioner may not operate normally due to control system.
- The place where there is a danger of existing combustible gas, carbon fiber or flammable dust.
- The place where thinner or gasoline is handled
Gas may leak and it may cause fire.

If the air conditioner is installed in a small room, measures must be taken to prevent the refrigerant concentration in the room from exceeding the safety limit in the event of refrigerant leakage.

Consult a dealer regarding the appropriate measures to prevent the allowable concentration from being exceeded.

- If the refrigerant leaks, and cause the concentration limit to be exceeded, hazards due to lack of oxygen in the room may result.

Install the air conditioner away from direct exposure to sunlight, heating apparatus, and humid places.

- Hang curtains on windows to boost cooling efficiency and to avoid the risk of electric shock.

The air conditioner is composed of moving parts. Keep children away from the unit to avoid physical injury.

Check for damage on delivery. If damaged, do not install the air conditioner and call the place of purchase immediately.

Insert the dust filter before operating the air conditioner.

- If there is no dust filter inside the air conditioner, accumulated dust may shorten the life of the air conditioner and cause electricity waste.

Keep indoor temperatures stable and not extremely cold, especially where there are children, elderly or disabled people.

safety information



CAUTION SIGNS

- ★ **Clean the dust filter every 2 weeks. Clean the filter more frequently if the air conditioner is operated in dusty areas.**

The packaging material and used batteries of the remote controller (optional) must be disposed of in accordance with the national standards.

The refrigerant used in the air conditioner must be treated as chemical waste. Dispose the refrigerant following national standards.

Have a qualified service technician install the air conditioner and perform a trial operation.

Firmly connect the drain hose to the air conditioner for proper water drainage.

Install the outdoor unit where operating noise and vibration will not disturb your neighbor and in a well-ventilated area with no obstacle.

- Potential risk of malfunction.
- Operating noise may disturb your neighbor.

Make sure that children take precautions against access to the air conditioner and they do not play with the unit.

When using a wireless remote control, the distance should not be more than 7 meters from the air conditioner.

If the remote control is not used for a long period of time, remove the batteries to prevent leakage of electrolyte.

When cleaning the outdoor unit, touch the heat exchanger radiator fins with extreme care.

- Wearing thick gloves can protect your hands.

Make sure that the condensed water dripping from the drain hose runs out properly and safely.

Store the operation and installation manual in a safe location and remember to hand it over to the new owner if the air conditioner is sold or transferred.

All the materials used for the manufacture and packaging of the air conditioner are recyclable.

After completing the installation, always carry out a functional test and provide the instructions on how to operate the air conditioner to the user.

The appliance is not intended for use by young children or infirm persons without supervision: Young children should be supervised to ensure that they do not play with the appliance.

Clean the air conditioner after the inner fan stops operating.

- Potential risk of injury or electric shock.

Inspect the condition, electric connections, pipes and external case of the air conditioner regularly by a qualified service technician.

safety information



CAUTION SIGNS

★ Do not open doors and windows in the room being cooled during operation unless necessary.

Do not block the air conditioner vents. If objects block the air flow, it may cause unit malfunction or poor performance.

Make sure there are no obstacles under the indoor unit.

- Potential risk of fire or loss of property.

Make sure that there are no obstacles or covers that block the air conditioner.

Allow sufficient space for air circulation.

- Insufficient ventilation may result in poor performance.

This appliance is not intended for use by persons (including children) with reduced physical, sensory or mental capabilities, or lack of experience and knowledge, unless they have been given supervision or instruction concerning use of the appliance by a person responsible for their safety. Children should be supervised to ensure that they do not play with the appliance.

Make sure the voltage and frequency of the electric system are compatible with the air conditioner.

If a power outage occurs while the air conditioner is working, turn off the power source immediately.

Max current is measured according to IEC standard for safety and current is measured according to ISO standard for energy efficiency.

The unit must be plugged into an independent circuit if applicable or connect the power cable to the auxiliary circuit breaker. An all pole disconnection from the power supply must be incorporated in the fixed wiring with a contact opening of >3mm.

After connecting the power cable between the indoor/outdoor unit, attach the cover of component box securely and make sure it is not loose.

For the power cable, use the grade of H07RN-F or H05RN-F materials.

The unbalanced power must be maintained within 10% of supply rating among whole indoor units.

If the power is unbalanced greatly, it may shorten the life of the condenser.

If the unbalanced power is exceeded over 10% of supply rating, the indoor unit is protected, stopped and the error mode indicates.

safety information



CAUTION SIGNS

- ★ To protect the product from water and possible shock, you should keep the power cable and the connection cord of the indoor and outdoor units in the protection tube.

Connect the power cable to the auxiliary circuit breaker.

You must keep the cable in a protection tube.

Keep distances of 50mm or more between power cable and communication cable.

Maximum length of power cable is decided within 10% of power drop. If it exceeds, you must consider another power supplying method.

The circuit breaker (MCCB, ELB) should be considered more capacity, if many indoor units are connected from one breaker.

Use solderless ring terminal to connect the power cable to the power terminal block.

Use an appropriate screwdriver for tightening the terminal screws.

Over-tightening the terminal screws may break them.

The air conditioner should be used only for the applications for which it has been designed: the indoor unit is not suitable to be installed in areas used for laundry.

Our units must be installed in compliance with the spaces indicated in the installation manual to ensure either accessibility from both sides or ability to perform routine maintenance and repairs. The units' components must be accessible and that can be disassembled in conditions of complete safety either for people or things. For this reason, where it is not observed as indicated into the Installation Manual, the cost necessary to reach and repair the unit (in safety, as required by current regulations in force) with slings, trucks, scaffolding or any other means of elevation won't be considered in-warranty and charged to end user.



Ensure the off-on and protection switches are properly installed.

Do not use the air conditioner if damaged. If problems occur, immediately stop operation and disconnect the plug from the power supply.

If the air conditioner will not be used for an extended period of time (for example, over several months), unplug the power from the wall.

safety information



Call the place of purchase or a contact center if repairs are needed.

- Potential risk of fire or electric shock if disassembly or repairs are attempted by a non-qualified service technician.

If you smell burning plastic, hear strange sounds, or see smoke coming from the unit, unplug the air conditioner immediately and call a contact center.

- Potential risk of fire or electric shock.

contents

VIEWING YOUR AIR CONDITIONER	22	Slim 1 way cassette
	22	2 way cassette
	23	4 way cassette
	22	
USING YOUR AIR CONDITIONER	24	Tips on using your air conditioner
	24	
CLEANING AND MAINTAINING THE AIR CONDITIONER	26	Cleaning the exterior
	26	Cleaning the grille
	26	Slim 1 way cassette
	28	2 way cassette
	29	4 way cassette
	30	Cleaning the filter
	30	Slim 1 way cassette
	32	2 way cassette
	33	4 way cassette
	34	Maintaining your air conditioner
	34	Periodical checks
	35	Internal protections via the unit control system
APPENDIX	36	Troubleshooting
	39	Operation ranges
	36	
INSTALLING YOUR AIR CONDITIONER	40	Installation part
	40	

This product has been determined to be in compliance with the Low Voltage Directive (2006/95/EC), and the Electromagnetic Compatibility Directive (2004/108/EC) of the European Union.



Correct Disposal of This Product (Waste Electrical & Electronic Equipment)

(Applicable in countries with separate collection systems)

This marking on the product, accessories or literature indicates that the product and its electronic accessories (e.g. charger, headset, USB cable) should not be disposed of with other household waste at the end of their working life. To prevent possible harm to the environment or human health from uncontrolled waste disposal, please separate these items from other types of waste and recycle them responsibly to promote the sustainable reuse of material resources.

Household users should contact either the retailer where they purchased this product, or their local government office, for details of where and how they can take these items for environmentally safe recycling.

Business users should contact their supplier and check the terms and conditions of the purchase contract. This product and its electronic accessories should not be mixed with other commercial wastes for disposal.

viewing your air conditioner

Congratulations on the purchase of the air conditioner. We hope you enjoy the features of your air conditioner and stay cool or warm with optimal efficiency.

Please read the user manual to get started and to make the best use of the air conditioner.

SLIM 1 WAY CASSETTE

Main parts

◆ PC1NUSMAN

◆ PC1NUPMAN

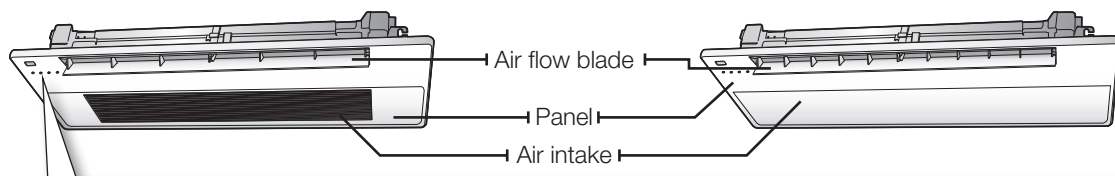

Display

Heating and cooling model
Operation(Blue) / Defrost(Yellow)

Cooling only model
Operation indicator

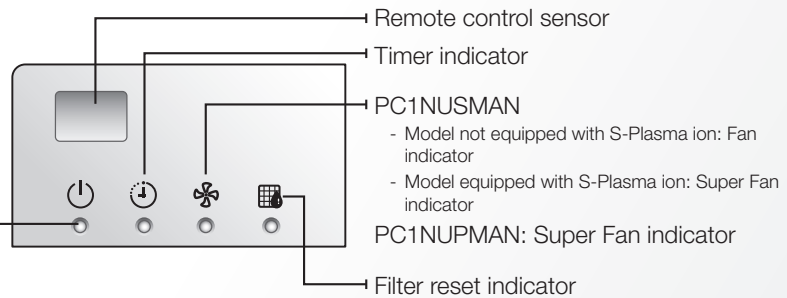

 When operating an indoor unit (including Fan mode), SPi will not operate automatically. So, press the [Super Fan] button on the wireless remote controller to operate SPi.

2 WAY CASSETTE

Main parts

◆ PC2NUSMEN

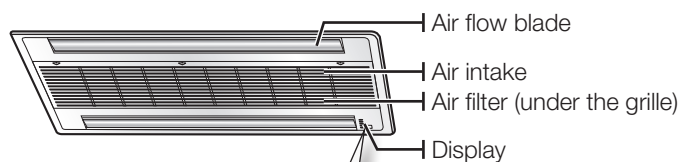

Display

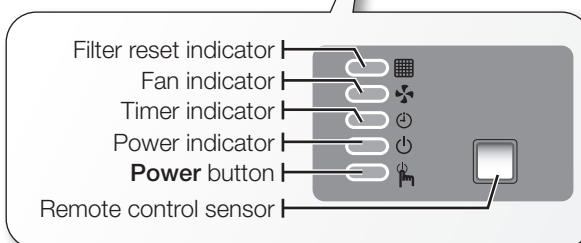

 Your air conditioner and display may look slightly different from the illustration shown above depending on your model.

4 WAY CASSETTE

Main parts

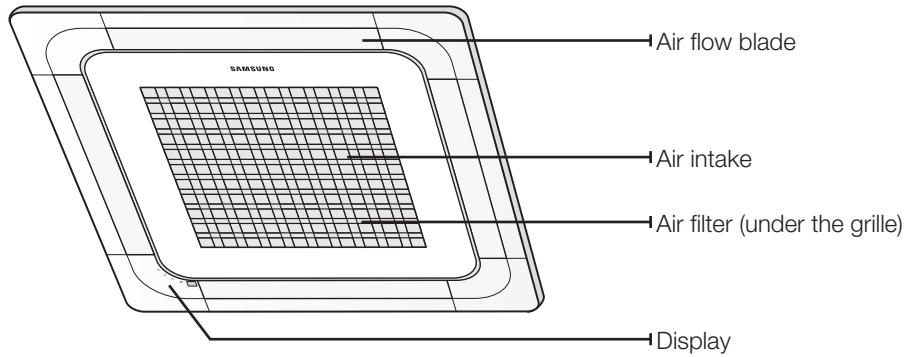

Indicator

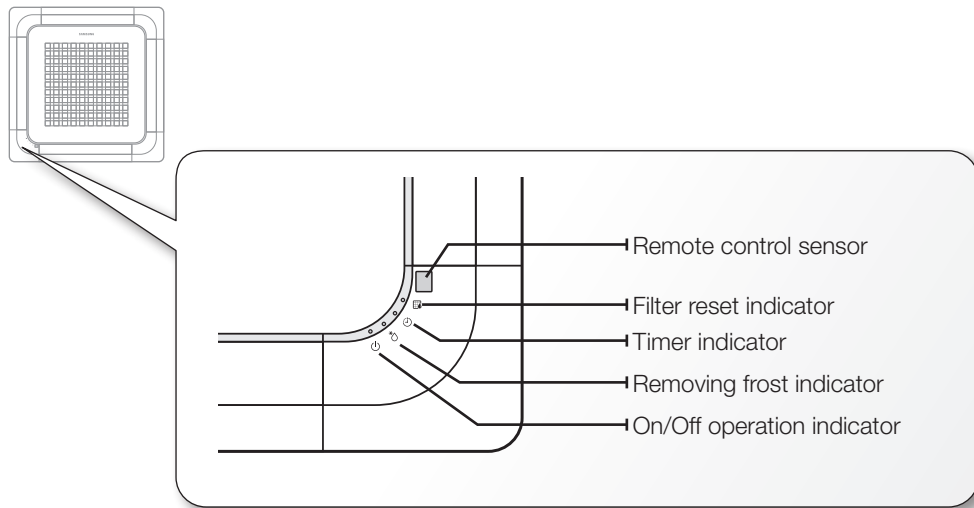

 Your air conditioner and display may look slightly different from the illustration shown above depending on your model.

using your air conditioner

TIPS ON USING AIR CONDITIONER

Here are some tips that you would follow when using your air conditioner.

TOPIC	RECOMMENDATION
Cooling	<ul style="list-style-type: none">• If current outside temperatures are much higher than the selected indoor temperature, it may take time to bring the inner temperature to the desired coolness.• Avoid drastically turning down the temperature. Energy is wasted and the room does not cool faster.
Heating	<ul style="list-style-type: none">• Since the air conditioner heats the room by taking heat energy from outdoor air, the heating capacity may decrease when outdoor temperatures are extremely low. If you feel the air conditioner insufficiently heats, using an additional heating appliance in combination with the air conditioner is recommended.
Frost & De-ice	<ul style="list-style-type: none">• When the air conditioner runs in Heat mode, due to temperature difference between the unit and the outside air, frost will form. If this happens:<ul style="list-style-type: none">- The air conditioner stops heating.- The air conditioner will operate automatically in De-ice mode for 10 minutes.

Frost & De-ice	<p>- The steam produced on the outdoor unit in De-ice mode is safe.</p> <p>No intervention is required; after about 10 minutes, the air conditioner operates again normally.</p> <p> The unit will not operate when it starts to de-ice.</p>
Fan	<ul style="list-style-type: none"> • Fan may not operate for about 3~5 minutes at the beginning to prevent any cold blasts while the air conditioner is warming up.
High indoor/ outdoor temperatures	<ul style="list-style-type: none"> • If both indoor and outdoor temperatures are high and the air conditioner is running in Heat mode, the outdoor unit's fan and compressor may stop at times. This is normal; wait until the air conditioner turns on again.
Power failure	<ul style="list-style-type: none"> • If a power failure occurs during the operation of the air conditioner, the operating immediately stops and unit will be off. When power returns, the air conditioner will run automatically.
Protection mechanism	<ul style="list-style-type: none"> • If the air conditioner has just been turned on after operation stops or being plugged in, cool/warm air does not come out for 3 minutes to protect the compressor of the outdoor unit.

cleaning and maintaining the air conditioner

For the best performance of your air conditioner, clean it periodically. When cleaning, make sure to unplug the unit for user's safety.

CLEANING THE EXTERIOR

1. Wipe the surface of the unit with a slightly wet or dry cloth when needed. Wipe off dirt of odd-shaped area by using a soft brush.

Example : 4 way cassette



Do not use benzene or thinner. They may damage the surface of the air conditioner and can create a risk of fire.

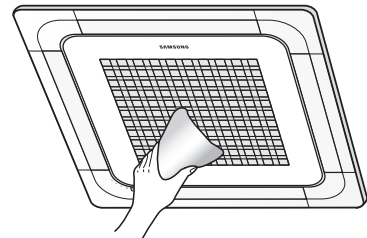

CLEANING THE GRILLE

When cleaning the grille, make sure to unplug the unit. No special tools are needed to clean it.

Slim 1 way cassette

1. Open the grille.

Press the [Push] signs (PC1NUSMAN : Located in 3 places) and open the grille.

◆ PC1NUSMAN

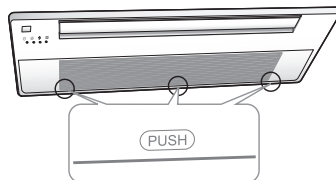

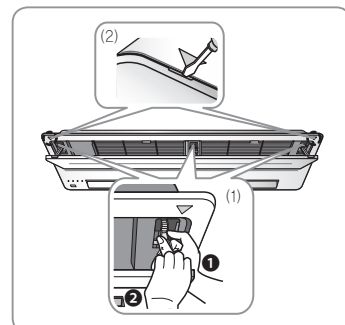

◆ PC1NUPMAN

- When detaching the panel, grip the link part where the panel and intake panel are connected ① and push up the link at the panel part ② to disconnect as shown in the picture (1).
- When power supply malfunctions, detach the panel by using a driver at the marked point (2) and proceed with the same method as shown in the picture (1) to detach the panel and then check the power connection status.

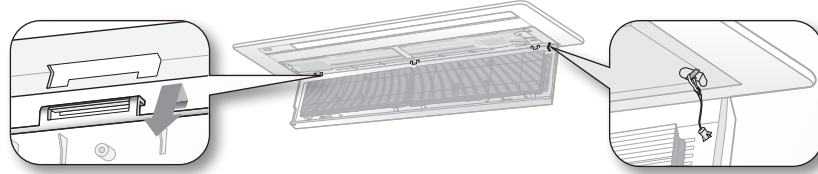

2. Unhook the safety clips by holding the front grille.
3. Detach the front grille.
Hold the front grille at a 45° angle, lift it up slightly and then pull the grille forward.



CAUTION  Hold the grille to prevent dropping outside from the opening of the front grille. If not, it may cause a potential risk of personal injury.

 Cleaning the grille is also available while being attached to the panel.

4. Pull out the Air filter.
Grab the Air filter and lift it upwards while pushing slightly, and then pull the Air filter forward.
5. Clean the grille with a vacuum cleaner or soft brush. If dust is too heavy, then rinse it with running water and dry it in a ventilated area.

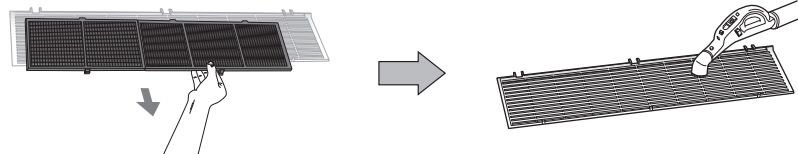

6. Insert the Air filter back in its original position.
7. Reattach the front grille.
Place the hook on the unit to the right place then push the front grille upward. Mount the safety clips to its original position.

 The illustration shown above may differ from yours depending on your model.

cleaning and maintaining the air conditioner

CLEANING THE GRILLE

2 way cassette

◆ PC2NUSMEN

1. Open the front grille.

Push the [▼] tabs located in 3 places to unlock the groove on the front grille. The grille automatically drops. Two safety clips are mounted to the inside front grille to prevent dropping downward.

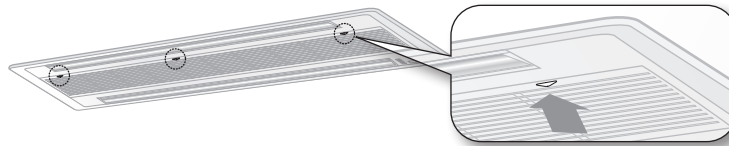

2. Unhook the safety clips by holding the front grille.

3. Detach the front grille.

Hold the front grille at a 45° angle, lift it up slightly and then pull the grille forward.

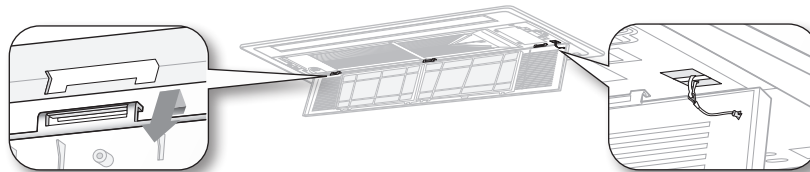

CAUTION

Hold the grille to prevent dropping outside from the opening of the front grille. If not, it may cause a potential risk of personal injury.



Cleaning the grille is also available while being attached to the panel.

4. Pull out the Air filter.

Grab the Air filter and lift it upwards while pushing slightly, and then pull the Air filter forward.

5. Clean the grille with a vacuum cleaner or soft brush. If dust is too heavy, then rinse it with running water and dry it in a ventilated area.

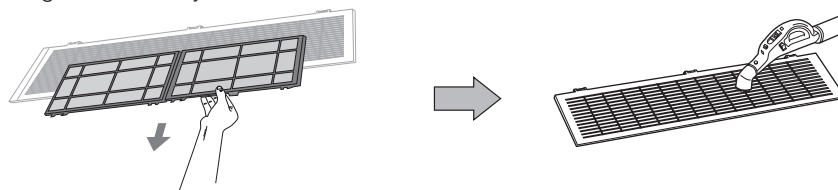

6. Insert the Air filter back in its original position.

7. Reattach the front grille.

Place the hook on the unit to the right place then push the front grille upward. Mount the safety clips to its original position.

4 way cassette

◆ PC4NUSKAN / PC4NUSKEN / PC4NBSKAN

1. Open the front grille.

Open the blades on the left and right side of the Samsung logo. Press both of the levers and pull the grille downward. Two safety clips are mounted to the front grille to prevent it from dropping.

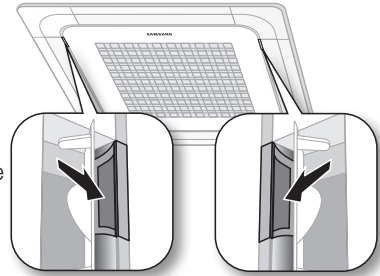

2. Detach the front grille.

Remove the safety clip first and then remove the hinge. Pull the green switch on the hinge part down and then press and pull the hinge part to remove the grillae. (There are two hinges on the grille and you must apply this step on both of them to remove the grille.)

* If you want to clean the filter only, you do not have to detach the grille. Follow step 4 and 5

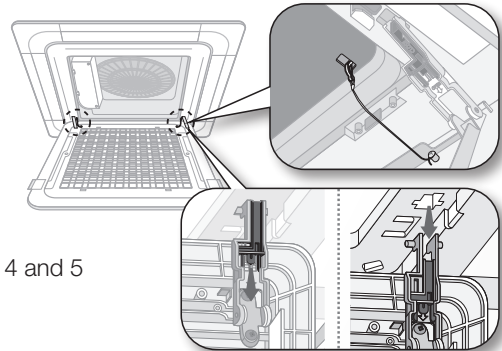

3. Pull out the Air filter.

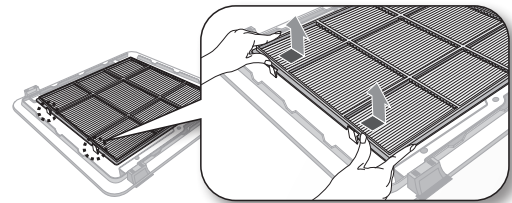

4. Clean the grille and Air filter with a vacuum cleaner or soft brush. If dust is too heavy, then rinse it with running water and dry it in a ventilated area.

For best conditions, repeat every two weeks.

If the Air filter dries in a confined (or humid) area, odors may generate. If it occurs, re-clean and dry it in a well-ventilated area.

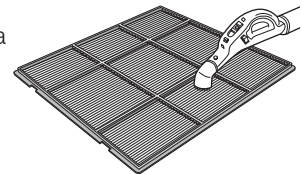

5. Insert the Air filter back in its original position.

You will hear a click sound when the Air filter is properly placed.

6. Attach the front grille.

Reverse the above steps to attach the front grille.

- ☑ • The illustration shown above may differ from yours depending on your model.
- After cleaning the filter, press the Filter Reset button on the remote control for 2 seconds to reset the filter schedule. Filter sign indicator will be on for cleaning time.
- If the angle on the air flow blades has been changed by user due to opening the front grille for installation or maintenance, you must turn off the circuit breaker and turn it on again before using the air conditioner. Otherwise, angles of the each angle can be different or some of the blade may not close when the product is off.

cleaning and maintaining the air conditioner

CLEANING THE FILTER

When cleaning the filter, make sure to unplug the power from the unit. Washable foam based Air filter captures large particles from the air. The filter is cleaned with a vacuum or by hand washing.

Slim 1 way cassette

1. Open the grille.

Press the [Push] signs (PC1NUSMAN : Located in 3 places) and open the grille.

◆ PC1NUSMAN

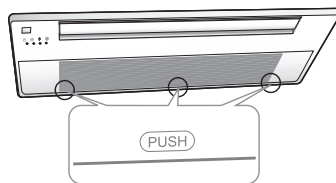

◆ PC1NUPMAN

- When detaching the panel, grip the link part where the panel and intake panel are connected ① and push up the link at the panel part ② to disconnect as shown in the picture (1).
- When power supply malfunctions, detach the panel by using a driver at the marked point (2) and proceed with the same method as shown in the picture (1) to detach the panel and then check the power connection status.

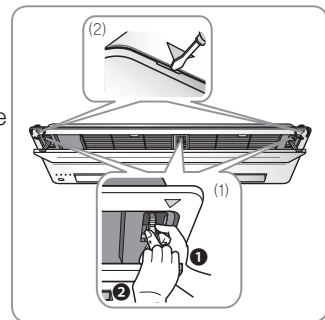

2. Pull out the Air filter.

Grab the Air filter and lift it upwards while pushing slightly, and then pull the Air filter forward.

-  When cleaning the filter you do not need to detach the grille at all times. If you want to detach the front grille, see step 2 and 3 on page 27 for instructions.

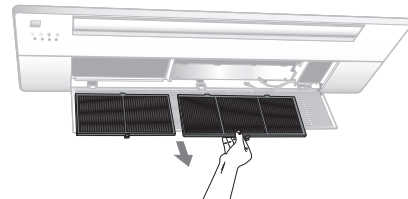

-
3. Clean the Air filter with a vacuum cleaner or soft brush. If dust is too heavy, then rinse it with running water and dry it in a ventilated area.

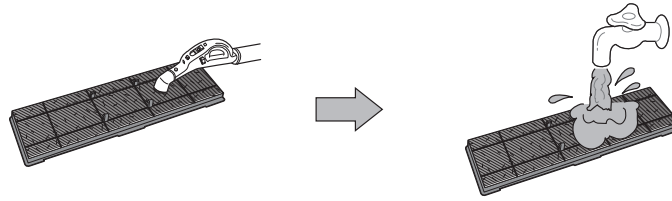

- For best conditions, repeat every two weeks.
- If the Air filter dries in a confined (or humid) area, odors may generate. If it occurs, re-clean and dry it in a well-ventilated area.

-
4. Insert the Air filter back in its original position.
You will hear a click sound when the Air filter is properly placed.
5. Close the front grille by pushing it upward.

-
- The illustration shown above may differ from yours depending on your model.
 - After cleaning the filter, press the **Filter Reset** button on the remote control for 2 seconds to reset the filter schedule. Filter sign indicator will be on for cleaning time.

cleaning and maintaining the air conditioner

CLEANING THE FILTER

When cleaning the filter, make sure to unplug the power from the unit. Washable foam based Air filter captures large particles from the air. The filter is cleaned with a vacuum or by hand washing.

2 way cassette

1. Open the front grille.

Push the [▼] tabs located in 3 places to unlock the hook on the front grille.

The grille automatically drops. Two safety clips are mounted to the inside front grille to prevent dropping downward.

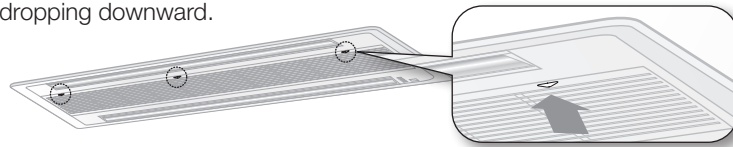

2. Pull out the Air filter.

Grab the Air filter and lift it upwards while pushing slightly, and then pull the Air filter forward.

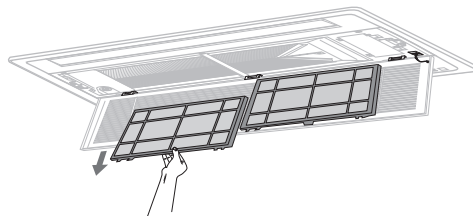

-  When cleaning the filter you do not need to detach the grille at all times. If you want to detach the front grille, see step 2 and 3 on page 27 for instructions.

3. Clean the Air filter with a vacuum cleaner or soft brush. If dust is too heavy, then rinse it with running water and dry it in a ventilated area.

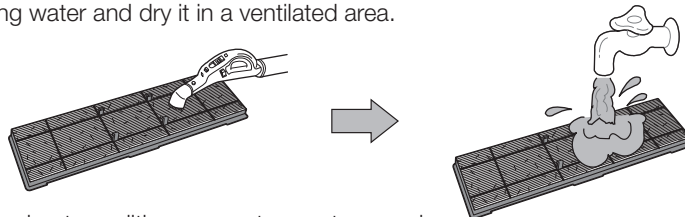

-  • For best conditions, repeat every two weeks.
• If the Air filter dries in a confined (or humid) area, odors may generate. If it occurs, re-clean and dry it in a well-ventilated area.

4. Insert the Air filter back in its original position.

You will hear a click sound when the Air filter is properly placed.

5. Close the front grille by pushing it upward.

- ☑ After cleaning the filter, press the **Filter Reset** button on the remote control for 2 seconds to reset the filter schedule. Filter sign indicator will be on for cleaning time.

4 way cassette

1. Push both of the tabs outwards to unlock the hook on the front grille.

The grille automatically drops. Two safety clips are mounted to the inside front grille to prevent dropping downward.

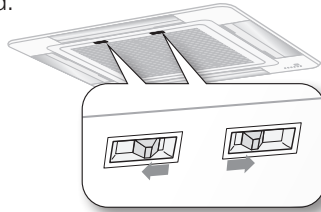

2. Pull out the Air filter.

Grab the Air filter and lift it upwards while pushing slightly, and then pull the Air filter forward.

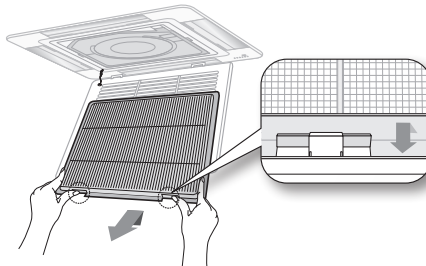

- ☑ When cleaning the filter you do not need to detach the grille at all times. If you want to detach the front grille, see step 2 and 3 on page 27 for instructions.

3. Clean the Air filter with a vacuum cleaner or soft brush. If dust is too heavy, then rinse it with running water and dry it in a ventilated area.

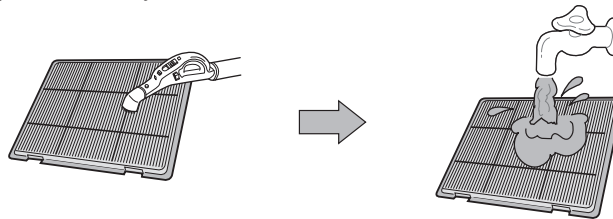

- ☑
 - For best conditions, repeat every two weeks.
 - If the Air filter dries in a confined (or humid) area, odors may generate. If it occurs, re-clean and dry it in a well-ventilated area.

4. Insert the Air filter back in its original position.

You will hear a click sound when the Air filter is properly placed.

5. Close the front grille by pushing it upward.

- ☑
 - The illustration shown above may differ from yours depending on your model.
 - After cleaning the filter, press the **Filter Reset** button on the remote control for 2 seconds to reset the filter schedule. Filter sign indicator will be on for cleaning time.

cleaning and maintaining the air conditioner

MAINTAINING YOUR AIR CONDITIONER

If the air conditioner will not be used for an extended period of time, dry the air conditioner to maintain it in best condition.

1. Dry the air conditioner thoroughly by operating in Fan mode for 3 to 4 hours and disconnect the power plug. There may be internal damage if moisture is left in components.
2. Before using the air conditioner again, dry the inner components of the air conditioner again by running in Fan mode for 3 to 4 hours. This helps remove odors which may have generated from dampness.

Periodical checks

Refer to the following chart to maintain the air conditioner properly.

Type	Description	Monthly	Every 4 months	Once a year
Indoor unit	Clean the air filter (1)	●		
	Clean the condensate drain pan (2)			●
	Thoroughly clean the heat exchanger (2)			●
	Clean the condensate drain pipe (2)		●	
	Replace the remote control batteries (1)			●
Outdoor unit	Clean the heat exchanger on the outside of the unit (2)		●	
	Clean the heat exchanger on the inside of the unit (2)			●
	Clean the electric components with jets of air (2)			●
	Verify that all the electric components are firmly tightened (2)			●
	Clean the fan (2)			●
	Verify that all the fan assembly is firmly tightened (2)			●
	Clean the condensate drain pan (2)			●

 The checks and maintenance operations described are essential to guarantee the efficiency of the air conditioner. The frequency of these operations varies according to the characteristics of the area, the amount of dust, etc.

(1) The described operations should be performed more frequently if the area of installation is very dusty.

(2) These operations must always be performed by qualified personnel. For more detailed information, see the Installation Manual.

Internal protections via the unit control system

This internal protection operates if an internal fault occurs in the air conditioner.

Type	Description
Against cold air	The internal fan will be off to against cold air when the heat pump is heating.
De-ice cycle	The internal fan will be off to against cold air when the heat pump is heating.
Anti-protection of internal battery	The compressor will be off to protect internal battery when the air conditioner operates in Cool mode.
Protect compressor	The air conditioner does not start operating immediately to protect the compressor of the outdoor unit after it has been started.

 If the heat pump is operating in Heat mode, De-ice cycle is actuated to remove frost from an outdoor unit that may have deposited at low temperatures.

The internal fan is switched off automatically and restarted only after the de-ice cycle is completed.

appendix

TROUBLESHOOTING

Refer to the following chart if the air conditioner operates abnormally. This may save time and unnecessary expenses.

PROBLEM	SOLUTION
The air conditioner does not operate immediately after it has been restarted.	<ul style="list-style-type: none">• Because of the protective mechanism, the appliance does not start operating immediately to keep the unit from overloading. The air conditioner will start in 3 minutes.
The air conditioner does not work at all.	<ul style="list-style-type: none">• Check that the power plug is properly connected. Insert the power plug into the wall socket correctly.• Check if the circuit breaker is switched off.• Check if there is a power failure.• Check your fuse. Make sure it is not blown out.
The temperature does not change.	<ul style="list-style-type: none">• Check if you selected Fan mode. Press the Mode button on the remote control to select another mode.
The cool (warm) air does not come out of the air conditioner.	<ul style="list-style-type: none">• Check if the set temperature is higher (lower) than the current temperature. Press the Temperature button on the remote control to change the set temperature. Press the Temperature button to decrease or increase the temperature.

<p>The cool (warm) air does not come out of the air conditioner.</p>	<ul style="list-style-type: none"> • Check if the air filter is blocked by dirt. Clean the air filter every two weeks. • Check if the air conditioner has just been turned on. If so, wait 3 minutes. Cool air does not come out to protect the compressor of the outdoor unit. • Check if the air conditioner is installed in a place with a direct exposure to sunlight. Hang curtains on windows to boost cooling efficiency. • Check if the cover or any obstacle is not near the outdoor unit. • Check if the refrigerant pipe is too long. • Check if the air conditioner is only available in Cool mode. • Check if the remote control is only available for cooling model.
<p>The fan speed does not change.</p>	<ul style="list-style-type: none"> • Check if you selected Auto or Dry mode. The air conditioner automatically adjusts the fan speed to Auto in Auto/Dry mode.
<p>Timer function does not set.</p>	<ul style="list-style-type: none"> • Check if you press the Power button on the remote control after you have set the time.

appendix

PROBLEM	SOLUTION
Odors permeate in the room during operation.	<ul style="list-style-type: none"> • Check if the appliance is running in a smoky area or if there is a smell entering from outside. Operate the air conditioner in Fan mode or open the windows to air out the room.
The air conditioner makes a bubbling sound.	<ul style="list-style-type: none"> • A bubbling sound may be heard when the refrigerant is circulating through the compressor. Let the air conditioner operate in a selected mode. • When you press the Power button on the remote control, noise may be heard from the drain pump inside the air conditioner.
Water is dripping from the air flow blades.	<ul style="list-style-type: none"> • Check if the air conditioner has been cooling for an extended period of time with the air flow blades pointed downwards. Condensation may generate due to the difference in temperature.
Remote control is not working.	<ul style="list-style-type: none"> • Check if your batteries are depleted. • Make sure batteries are correctly installed. • Make sure nothing is blocking your remote control sensor. • Check that there are strong lighting apparatus near the air conditioner. Strong light which comes from fluorescent bulbs or neon signs may interrupt the electric waves.

The air conditioner does not turn on or off with the wired remote control.	<ul style="list-style-type: none"> • Check if you set the wired remote control for group control.
The wired remote control does not operate.	<ul style="list-style-type: none"> • Check if TEST indicator is displayed on the wired remote control. If so, turn off the unit and switch off the circuit breaker. Call your nearest contact center.
The indicators of the digital display flashes.	<ul style="list-style-type: none"> • Press the Power button on the remote control to turn the unit off and switch the circuit breaker off. Then, switch it on again.

OPERATION RANGES

The table below indicates the temperature and humidity ranges the air conditioner can be operated within. Refer to the table for efficient use.

MODE	Indoor temperature	Outdoor temperature	Indoor humidity
Cooling	18~32°C	-5~48°C	80% or less
Heating	27°C or less	-20~24°C	-
Drying	18~32°C	-5~48°C	-

Installation Part

Indoor Unit Installation

It is recommended to install the Y-joint before installing the indoor unit.

- Place the pattern sheet on the ceiling at the spot where you want to install the indoor unit.

Note Since the diagram is made of paper, it may shrink or stretch slightly due to temperature or humidity. For this reason, before drilling the holes maintain the correct dimensions between the markings.

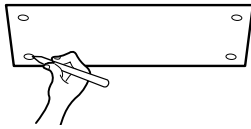

- Insert bolt anchors, use existing ceiling supports or construct a suitable support as shown in figure.

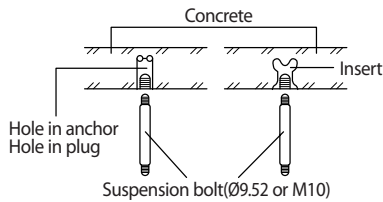

- Install the suspension bolts depending on the ceiling type.



- ◆ Ensure that the ceiling is strong enough to support the weight of the indoor unit. Before hanging the unit, test the strength of each attached suspension bolt.
- ◆ If the length of suspension bolt is more than 1.5m, it is required to prevent vibration.
- ◆ If this is not possible, create an opening in the false ceiling in order to be able to use it to perform the required operations on the indoor unit.

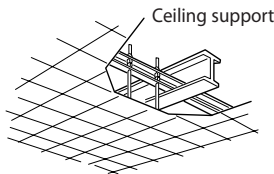

- Screw eight nuts to the suspension bolts making space for hanging the indoor unit.



You must install the suspension bolts more than four when installing the indoor unit.

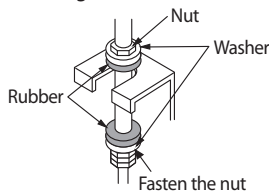

- Check the level of the indoor unit by using a level.
 - ◆ A tilt of the indoor unit may cause malfunction of a built-in float switch and water leaks.

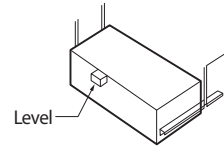

- Adjust the height of the indoor unit by using the gauge of dimensions.
 - ◆ You should adjust the gauge of dimensions and the pattern sheet to fit the cutting dimensions of ceiling.
 - ◆ Make sure that the indoor unit is installed at a level if the indoor unit slants too much, there can be water leaks.

Slim 1 way cassette

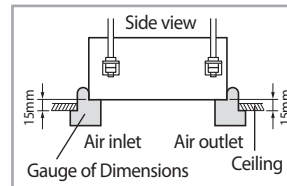

2 way cassette

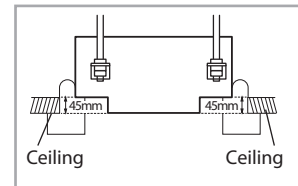

4 way cassette

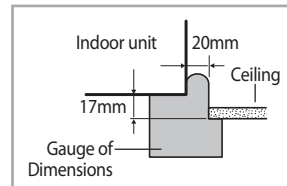

- Tighten the upper part nuts.

- Remove the gauge of dimensions after installing the indoor unit.

Performing Leak Test & Insulation

Leak test

LEAK TEST WITH NITROGEN (before opening valves)

In order to detect basic refrigerant leaks, before recreating the vacuum and recirculating the R-410A, it's responsible of installer to pressurize the whole system with nitrogen (using a pressure regulator) at a pressure above 4.1MPa (gauge).

LEAK TEST WITH R-410A (after opening valves)

Before opening valves, discharge all the nitrogen into the system and create vacuum. After opening valves check leaks using a leak detector for refrigerant R-410A.

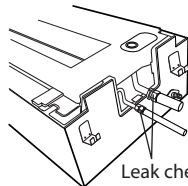

* The designs and shape are subject to change according to the model.



Discharge all the nitrogen to create a vacuum and charge the system.

Insulation

Once you have checked that there are no leaks in the system, you can insulate the piping and hose.

- To avoid condensation problems, place **T13.0 or thicker Acrylonitrile Butadiene Rubber** separately around each refrigerant pipe.

Note Always make the seam of pipes face upwards.

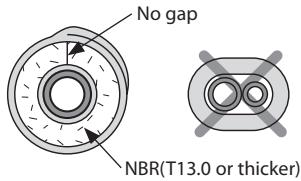

- Wind insulating tape around the pipes and drain hose avoiding to compress the insulation too much.

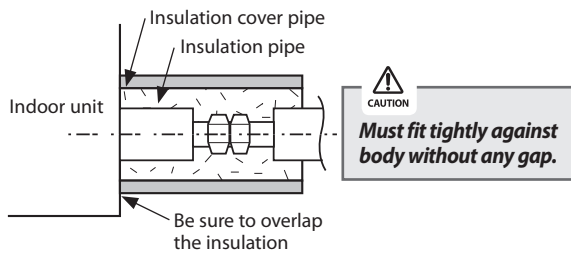

- Finish wrapping insulating tape around the rest of the pipes leading to the outdoor unit.
- The pipes and electrical cables connecting the indoor unit with the outdoor unit must be fixed to the wall with suitable ducts.



All refrigerant connection must be accessible, in order to permit either unit maintenance or removing it completely.

- Select the insulation of the refrigerant pipe.
 - Insulate the gas side and liquid side pipe referring to the thickness according to the pipe size.
 - Indoor temperature of 30°C and humidity of 85% is the standard condition. If installing in a high humidity condition, use one grade thicker insulator by referring to the table below.
 - Insulator's heat-resistance temperature should be more than 120°C.

Pipe	Pipe size	Insulation Type (Heating/Cooling)		Remarks
		Standard [30°C, 85%]	High humidity [30°C, over 85%]	
EPDM, NBR				
Liquid pipe	Ø6.35 ~ Ø9.52	9t	←	Internal temperature is higher than 120°C
	Ø12.7 ~ Ø50.80	13t	←	
Gas pipe	Ø6.35	13t	19t	
	Ø9.52 ~ Ø25.40	19t	25t	
	Ø28.58 ~ Ø44.45		32t	
	Ø50.80	25t	38t	

- When installing insulation in places and conditions below, use the same insulation that is used for high humidity conditions.
 - <Geological condition>
 - High humidity places such as shoreline, hot spring, near lake or river, and ridge (when the part of the building is covered by earth and sand.)
 - <Operation purpose condition>
 - Restaurant ceiling, sauna, swimming pool etc.
 - <Building construction condition>
 - The ceiling frequently exposed to moisture and cooling is not covered.
 - e.g. The pipe installed at a corridor of a dormitory and studio or near an exit that opens and closes frequently.
 - The place where the pipe is installed is highly humid due to the lack of ventilation system.



- Install the insulation not to get wider and use the adhesives on the connection part of it to prevent moisture from entering.
- Wind the refrigerant pipe with insulation tape if it is exposed to outside sunlight.
- Install the refrigerant pipe respecting that the insulation does not get thinner on the bent part or hanger of pipe.
- Add the additional insulation if the insulation plate gets thinner.

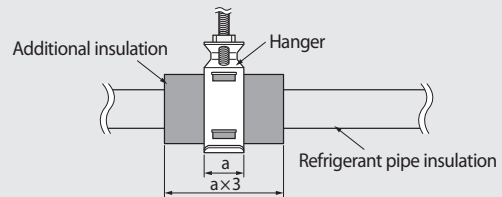

Drain pipe and Drain Hose Installation

- Install the drain pipe as shortly as possible.
 - Give a slightly slant to the drainpipe for proper drainage of condensate water.
 - There must be no gap on the connected part so that the drainpipe is not separated from the flexible hose.
- Insulate the drainpipe, and then fix it as indicated.
 - Whole drainpipe should be insulated by 5t(or more) insulation to prevent water condensation.

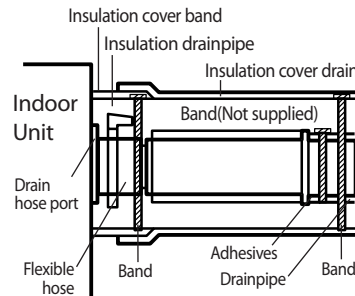

※ Flexible hose Installation

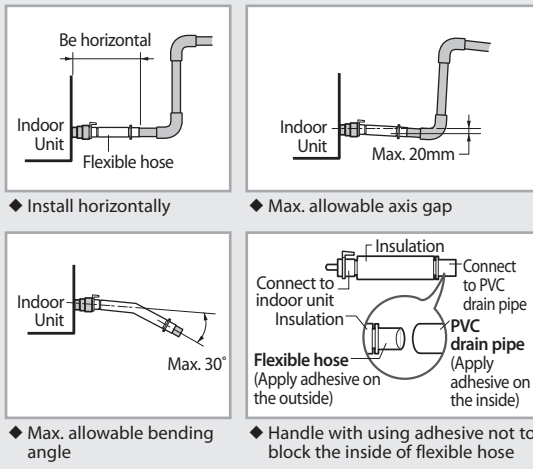

Drainpipe Connection

- The drain pipe should be installed within 100mm from the flexible hose, lift up from 100mm to 550mm and lift down 20mm or more.
- Install horizontal drainpipe with a slope of 1/100 or more and fix it by hanger space of 1~1.5m.
- Install the air vent in the horizontal drainpipe to prevent water flow back to the indoor unit.

Note You may not need to install it if there were proper slope in the horizontal drainpipe.
- The flexible hose should not be installed upward position, it may cause water flow back to the indoor unit.
- Install U-trap at the end of the drainpipe to prevent a nasty smell to reach the indoor unit.

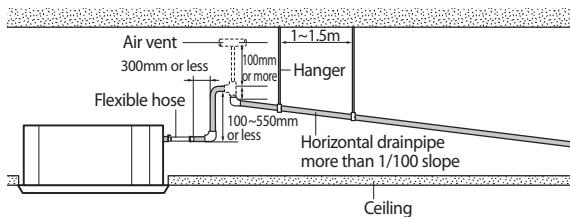

Centralized Drainage

- Install main air vent at the front of the farthest indoor unit from the main drain when installed indoor units are more than 3.
- You may need to install individual air vent to prevent water flow back at the top of each indoor unit drainpipe.

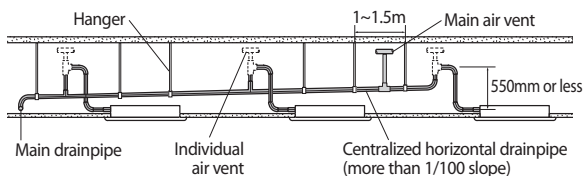

Wiring Work

Power and communication cable connection

- Before wiring work, you must turn off all power source.
- Indoor unit power should be supplied through the breaker(MCCB, ELB) separated by the outdoor power.
- The power cable should be used only copper wires.
- Connect the power cable(1(L), 2(N)) among the units within maximum length and communication cable(F1, F2) each.
- Connect F3, F4(for communication) when installing the wired remote control.

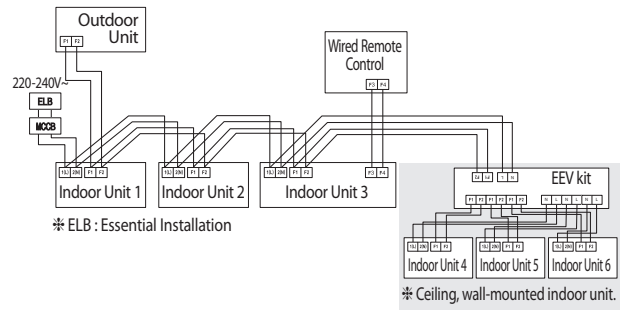

Selecting compressed ring terminal

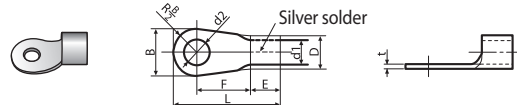

Nominal dimensions for cable (mm ²)	Nominal dimensions for screw (mm)	B		D		d1		E F L			d2		t
		Standard dimension (mm)	Allowance (mm)	Standard dimension (mm)	Allowance (mm)	Standard dimension (mm)	Allowance (mm)	Min.	Min.	Max.	Standard dimension (mm)	Allowance (mm)	
1.5	4	6.6	±0.2	3.4	+0.3 -0.2	1.7	±0.2	4.1	6	16	4.3	+0.2 0	0.7
	4	8											
2.5	4	6.6	±0.2	4.2	+0.3 -0.2	2.3	±0.2	6	6	17.5	4.3	+0.2 0	0.8
	4	8.5											
4	4	9.5	±0.2	5.6	+0.3 -0.2	3.4	±0.2	6	5	20	4.3	+0.2 0	0.9

Specification of electronic wire

Power supply	MCCB	ELB	Power cable	Earth cable	Communication cable
Max : 242V Min : 198V	X A	X A, 30mA 0.1 s	2.5mm ²	2.5mm ²	0.75~1.5mm ²

- ◆ Decide the capacity of ELB and MCCB by below formula.

$$\text{The capacity of ELB, MCCB } X [A] = 1.25 \times 1.1 \times \sum A_i$$

- * X : The capacity of ELB, MCCB
- * $\sum A_i$: Sum of Rating currents of each indoor unit.
- * Refer to each installation manual about the rating current of indoor unit.

- ◆ Decide the power cable specification and maximum length within 10% power drop among indoor units.

$$\sum_{k=1}^n \left(\frac{\text{Coef} \times 35.6 \times L_k \times i_k}{1000 \times A_k} \right) < 10\% \text{ of input voltage [V]}$$

- * Coef: 1.55
- * L_k : Distance among each indoor unit[m],
- * A_k : Power cable specification[mm²], i_k : Running current of each unit[A]

Setting an indoor unit address and installation option

Set the indoor unit address and installation option with remote controller option.

Set the each option separately since you cannot set the ADDRESS setting and indoor unit installation setting option at the same time. You need to set twice when setting indoor unit address and installation option.

The procedure of option setting

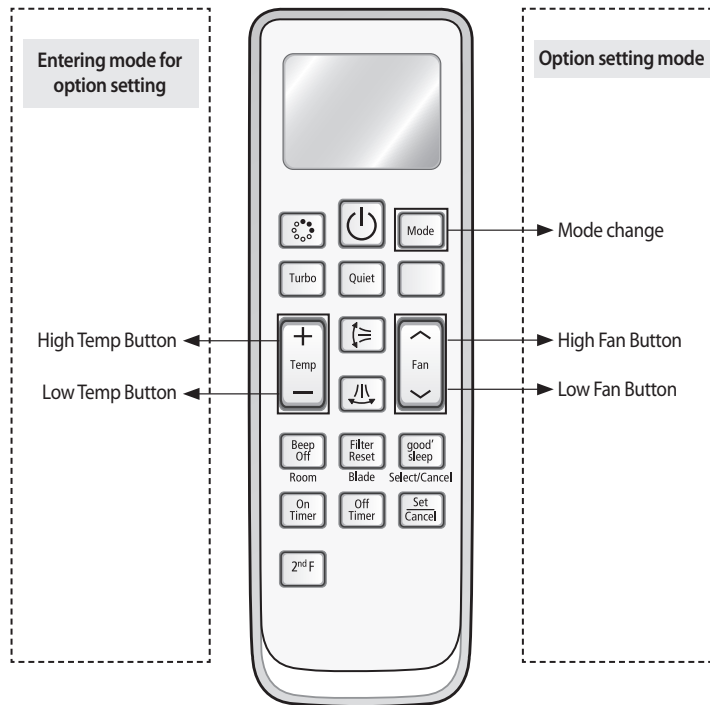

Step 1. Entering mode to set option

1. Remove batteries from the remote controller.
2. Insert batteries and enter the option setting mode while pressing High Temp button and Low Temp button.

3. Check if you have entered the option setting status.

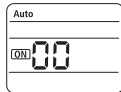

Step 2. The procedure of option setting

After entering the option setting status, select the option as listed below.











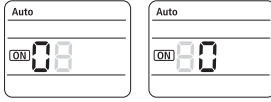
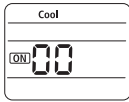
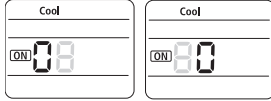
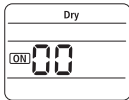

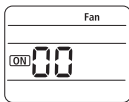
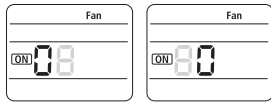
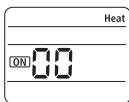
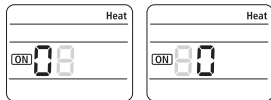
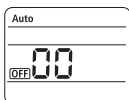
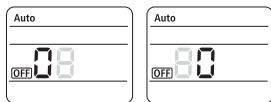
Option setting is available from SEG1 to SEG 24

- ◆ **SEG1, SEG7, SEG13, SEG19 are not set as page option.**
- ◆ **Set the SEG2~SEG6, SEG8~SEG12 as ON status and SEG14~18, SEG20~24 as OFF status.**

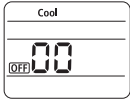
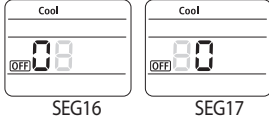
SEG1	SEG2	SEG3	SEG4	SEG5	SEG6	SEG7	SEG8	SEG9	SEG10	SEG11	SEG12	On(SEG1~12)	Off(SEG13~24)
0	X	X	X	X	X	1	X	X	X	X	X	Auto ON 00	Auto OFF 00
SEG13	SEG14	SEG15	SEG16	SEG17	SEG18	SEG19	SEG20	SEG21	SEG22	SEG23	SEG24		
2	X	X	X	X	X	3	X	X	X	X	X		

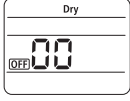
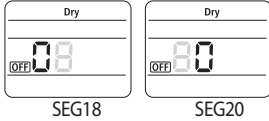
Setting an indoor unit address and installation option

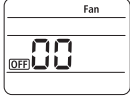
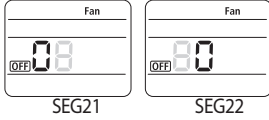
Option setting	Status
<p>1. Setting SEG2, SEG3 option Press Low Fan button(V) to enter SEG2 value. Press High Fan button(^) to enter SEG3 value. Each time you press the button, 0 → 1 → ... → 9 → F will be selected in rotation.</p>	
<p>2. Setting Cool mode <input type="checkbox"/> Mode Press Mode button to be changed to Cool mode in the ON status.</p>	
<p>3. Setting SEG4, SEG5 option Press Low Fan button(V) to enter SEG4 value. Press High Fan button(^) to enter SEG5 value. Each time you press the button, 0 → 1 → ... → 9 → F will be selected in rotation.</p>	
<p>4. Setting Dry mode <input type="checkbox"/> Mode Press Mode button to be changed to DRY mode in the ON status.</p>	
<p>5. Setting SEG6, SEG8 option Press Low Fan button(V) to enter SEG6 value. Press High Fan button(^) to enter SEG8 value. Each time you press the button, 0 → 1 → ... → 9 → F will be selected in rotation.</p>	
<p>6. Setting Fan mode <input type="checkbox"/> Mode Press Mode button to be changed to FAN mode in the ON status.</p>	
<p>7. Setting SEG9, SEG10 option Press Low Fan button(V) to enter SEG9 value. Press High Fan button(^) to enter SEG10 value. Each time you press the button, 0 → 1 → ... → 9 → F will be selected in rotation.</p>	
<p>8. Setting Heat mode <input type="checkbox"/> Mode Press Mode button to be changed to HEAT mode in the ON status.</p>	
<p>9. Setting SEG11, SEG12 option Press Low Fan button(V) to enter SEG11 value. Press High Fan button(^) to enter SEG12 value. Each time you press the button, 0 → 1 → ... → 9 → F will be selected in rotation.</p>	
<p>10. Setting Auto mode <input type="checkbox"/> Mode Press Mode button to be changed to AUTO mode in the OFF status.</p>	
<p>11. Setting SEG14, SEG15 option Press Low Fan button(V) to enter SEG14 value. Press High Fan button(^) to enter SEG15 value. Each time you press the button, 0 → 1 → ... → 9 → F will be selected in rotation.</p>	

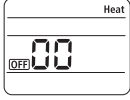
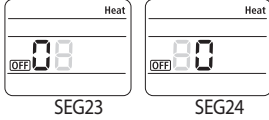
Option setting	Status
<p>12. Setting Cool mode</p> <p> Press Mode button to be change to Cool mode in the OFF status.</p>	
<p>13. Setting SEG16, SEG17 option</p> <p>Press Low Fan button(∨) to enter SEG16 value. Press High Fan button(∧) to enter SEG17 value. Each time you press the button, 0 → 1 → ... 8 → 9 will be selected in rotation.</p>	
<p>14. Setting Dry mode</p> <p> Press Mode button to be change to Dry mode in the OFF status.</p>	
<p>15. Setting SEG18, SEG20 option</p> <p>Press Low Fan button(∨) to enter SEG18 value. Press High Fan button(∧) to enter SEG20 value. Each time you press the button, 0 → 1 → ... 8 → 9 will be selected in rotation.</p>	
<p>16. Setting Fan mode</p> <p> Press Mode button to be change to Fan mode in the OFF status.</p>	
<p>17. Setting SEG21, SEG22 option</p> <p>Press Low Fan button(∨) to enter SEG21 value. Press High Fan button(∧) to enter SEG22 value. Each time you press the button, 0 → 1 → ... 8 → 9 will be selected in rotation.</p>	
<p>18. Setting Heat mode</p> <p> Press Mode button to be change to HEAT mode in the OFF status.</p>	
<p>19. Setting SEG23, SEG24 mode</p> <p>Press Low Fan button(∨) to enter SEG23 value. Press High Fan button(∧) to enter SEG24 value. Each time you press the button, 0 → 1 → ... 8 → 9 will be selected in rotation.</p>	

Step 3. Check the option you have set

After setting an option, press  button to check whether the option code you input is correct or not.

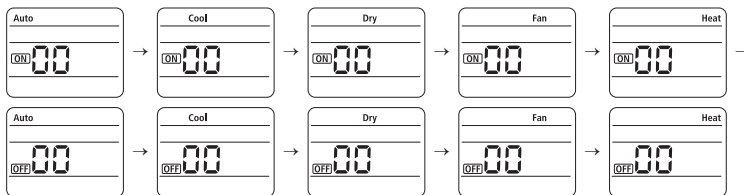

Step 4. Input option

Press the operation button  with the direction of remote control for set.
For the correct option setting, you must input the option twice.

Step 5. Check operation

1. Reset the indoor unit by pressing the RESET button of indoor unit or outdoor unit.
2. Take the batteries out of the remote controller and insert them again and then press the operation button.

Setting an indoor unit address and installation option

Setting an indoor unit address (MAIN/RMC)

1. Check whether power is supplied or not.
 - When the indoor unit is not plugged in, there should be additional power supply in the indoor unit.
2. The panel(display) should be connected to an indoor unit to receive option.
3. Before installing the indoor unit, assign an address to the indoor unit according to the air conditioning system plan.
4. Assign an indoor unit address by wireless remote controller.
 - The initial setting status of indoor unit ADDRESS(MAIN/RMC) is "0A0000-100000-200000-300000".

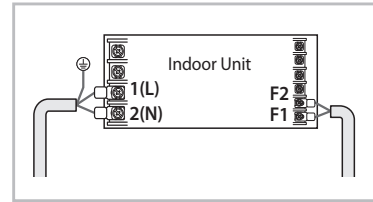

Option No. : 0AXXXX-1XXXXX-2XXXXX-3XXXXX

Option	SEG1		SEG2		SEG3		SEG4		SEG5		SEG6	
Explanation	PAGE		MODE		Setting Main address		100-digit of indoor unit address		10-digit of indoor unit		The unit digit of an indoor unit	
Remote Controller Display												
Indication and Details	Indication	Details	Indication	Details	Indication	Details	Indication	Details	Indication	Details	Indication	Details
	0		A		0	No Main address						
					1	Main address setting mode	0~9	100-digit	0~9	10-digit	0~9	A unit digit
Option	SEG7		SEG8		SEG9		SEG10		SEG11		SEG12	
Explanation	PAGE				Setting RMC address				Group channel(*16)		Group address	
Remote Controller Display												
Indication and Details	Indication	Details			Indication	Details			Indication	Details	Indication	Details
	1				0	No RMC address						
					1	RMC address setting mode			RMC1	0~F	RMC2	0~F



- ◆ When "A"~"F" is entered to SEG5~6, the indoor unit MAIN ADDRESS is not changed.
- ◆ If you set the SEG 3 as 0, the indoor unit will maintain the previous MAIN ADDRESS even if you input the option value of SEG5~6.
- ◆ If you set the SEG 9 as 0, the indoor unit will maintain previous RMC ADDRESS even if you input the option value of SEG11~12.
- ◆ You cannot set SEG11 and SEG12 as F value at the same time.

Setting an indoor unit installation option (suitable for the condition of each installation location)

1. Check whether power is supplied or not.
 - When the indoor unit is not plugged in, there should be additional power supply in the indoor unit.
2. The panel(display) should be connected to an indoor unit to receive option.
3. Set the installation option according to the installation condition of an air conditioner.
 - The default setting of an indoor unit installation option is "020010-100000- 200000-300000".
 - Individual control of a remote controller(SEG20) is the function that controls an indoor unit individually when there is more than one indoor unit.
4. Set the indoor unit option by wireless remote controller.

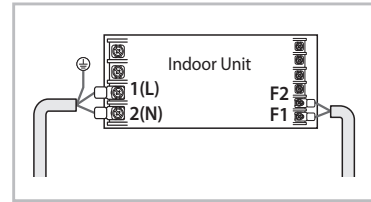

02 series installation option

SEG1	SEG2	SEG3	SEG4	SEG5	SEG6
0	2	-	External room temperature sensor	Central control	FAN RPM compensation
SEG7	SEG8	SEG9	SEG10	SEG11	SEG12
1	Drain pump	Hot water heater	-	EEV Step when heating stops	Master / Slave
SEG13	SEG14	SEG15	SEG16	SEG17	SEG18
2	External control	External control output	S-Plasma ion	Buzzer	Number of hours using filter
SEG19	SEG20	SEG21	SEG22	SEG23	SEG24
3	Individual control of a remote controller	Heating setting compensation	EEV Step of stopped unit during oil return/ defrost mode	Motion detect sensor	-

- ◆ 1WAY/2WAY/4WAY MODEL : Drain pump(SEG8) will be set to 'USE + 3minute delay' even if the drain pump is set to 0.
- ◆ 1 WAY/2WAY/4WAY,DUCT MODEL : Number of hours using filter(SEG18) will be set to '1000hour' even if the SEG18 is set to except for 2 or 6.
- ◆ When setting the option other than above SEG values, the option will be set as "0".
- ◆ SEG5 central control option is basically set as 1 (Use), so you don't need to set the central control option additionally. However, if the central control is not connected but it doesn't indicate an error message, you need to set the central control option as 0 (Disuse) to exclude the indoor unit from the central control.

Setting an indoor unit address and installation option

■ 02 series installation option(Detailed)

Option No. : 02XXXX-1XXXXX-2XXXXX-3XXXXX

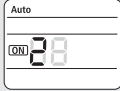
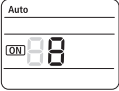
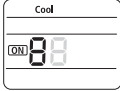
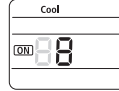
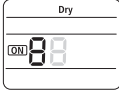
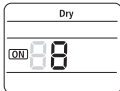
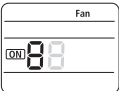
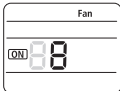
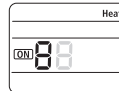
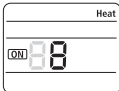
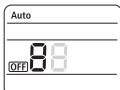
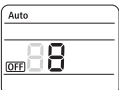
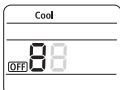
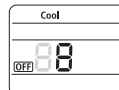
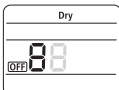
Option	SEG1		SEG2		SEG3		SEG4		SEG5		SEG6													
Explanation	PAGE		MODE		Use of robot cleaning		Use of external room temperature sensor		Use of central control		FAN RPM compensation													
Remote Controller Display																								
Indication and Details	Indication	Details	Indication	Details	Indication	Details	Indication	Details	Indication	Details	Indication	Details												
													0	2	0	Disuse	0	Disuse	0	Disuse	0	Disuse	1	RPM compensation
													1	Use	1	Use	1	Use	1	Use	2	High ceiling KIT		
Option	SEG7		SEG8		SEG9		SEG10		SEG11		SEG12													
Explanation	PAGE		Use of drain pump		Use of hot water heater		Use of electronic heater		EEV Step when heating stops		Master / Slave													
Remote Controller Display																								
Indication and Details	Indication	Details	Indication	Details	Indication	Details	Indication	Details	Indication	Details	Indication	Details												
													1	0	Disuse	0	Disuse	0	Disuse	0	Default value	0	slave	
													2	When an indoor unit stops, drain pump will operate for 3min.	1	Use	1	Use	1	Use	1	Noise decreasing setting	1	master
Option	SEG13		SEG14		SEG15		SEG16		SEG17		SEG18													
Explanation	PAGE		Use of external control		Setting the output of external control		S-Plasma ion		Buzzer control		Number of hours using filter													
Remote Controller Display																								
Indication and Details	Indication	Details	Indication	Details	Indication	Details	Indication	Details	Indication	Details	Indication	Details												
													2	0	Disuse	0	Thermo on	0	Disuse	0	Use buzzer	2	1000 Hour	
													1	ON/OFF control	1	Operation on	1	Use	1	Disuse buzzer	6	2000 Hour		
													2	OFF control										
													3	Window ON/OFF control										

Option	SEG19	SEG20	SEG21	SEG22	SEG23	SEG24				
Explanation	PAGE	Individual control of a remote controller	Heating setting compensation	EEV Step of stopped unit during oil return/defrost mode	Motion detect sensor	-				
Remote Controller Display										
Indication and Details	3	Indication	Details	Indication	Details	Indication	Details	Indication	Details	
		0 or 1	channel 1	0	Disuse	0	Default value	0	Disuse	
				1	2°C			1	Turn out in 30min. without motion	
		2	channel 2	2	5°C	1	Oil return or Noise decreasing in defrost mode	2	Turn out in 60min. without motion	
		3	channel 3					3	Turn out in 120min. without motion	
								4	Turn out in 180min. without motion	
		4	channel 4	5	Turn out in 30min. without motion or *advanced function					
				6	Turn out in 60min. without motion or *advanced function					
				7	Turn out in 120min. without motion or *advanced function					
				8	Turn out in 180min. without motion or *advanced function					

*Advanced function: Controlling cooling/heating current or power saving with motion detect.

■ 05 series installation option

SEG1	SEG2	SEG3	SEG4	SEG5	SEG6
0	5	Use of Auto Change Over for HR only in Auto mode	(When setting SEG3) Standard heating temp. Offset	(When setting SEG3) Standard cooling temp. Offset	(When setting SEG3) Standard for mode change Heating → Cooling
SEG7	SEG8	SEG9	SEG10	SEG11	SEG12
1	(When setting SEG3) Standard for mode change Cooling → Heating	(When setting SEG3) Time required for mode change	Compensation option for Long pipe or height difference between indoor units	-	-
SEG13	SEG14	SEG15	SEG16	SEG17	SEG18
2	-	-	-	-	-
SEG19	SEG20	SEG21	SEG22	SEG23	SEG24
3	-	-	-	-	-

Setting an indoor unit address and installation option

■ 05 series installation option(Detailed)

Option No. : 05XXXX-1XXXXX-2XXXXX-3XXXXX

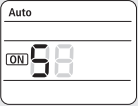
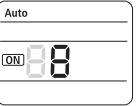
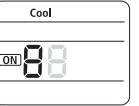
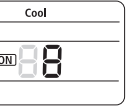
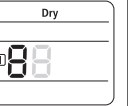
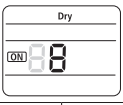
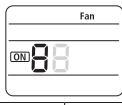
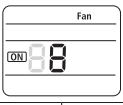
Option	SEG1		SEG2		SEG3		SEG4		SEG5		SEG6													
Explanation	PAGE		MODE		Use of Auto Change Over for HR only in Auto mode		(When setting SEG3) Standard heating temp. Offset		(When setting SEG3) Standard cooling temp. Offset		(When setting SEG3) Standard for mode change Heating → Cooling													
Remote Controller Display																								
Indication and Details	Indication	Details	Indication	Details	Indication	Details	Indication	Details	Indication	Details	Indication	Details												
													0	5	0	Follow product option	0	0	0	0	0	1		
													1	Use Auto Change Over for HR only	1	0.5	1	0.5	1	1.5	2	2	2	2
															2	1	2	1	2	2.5	3	3	3	3
															3	1.5	3	1.5	3	3.5	4	4	4	4
															4	2	4	2	4	4.5	5	5	5	5
															5	2.5	5	2.5	5	6	6	6	6	6
															6	3	6	3	6	7	7	7	7	7
7	3.5	7	3.5	7	4.5	8	8	8	8															
Option	SEG7		SEG8		SEG9		SEG10		SEG11		SEG12													
Explanation	PAGE		(When setting SEG3) Standard for mode changing Cooling → Heating mode		(When setting SEG3) Time required for mode change		Compensation option for Long pipe or height difference between indoor units																	
Remote Controller Display																								
Indication and Details	Indication	Details	Indication	Details	Indication	Details	Indication	Details	Indication	Details	Indication	Details												
													1	0	1	0	5 min.	0	Use default value					
														1	1.5	1	7 min.	1	1) Height difference ¹⁾ is more than 30m or 2) Distance ²⁾ is longer than 110m					
														2	2	2	9 min.							
														3	2.5	3	11 min.							
														4	3	4	13 min.							
														5	3.5	5	15 min.							
														6	4	6	20 min.							
7	4.5	7	30 min.	2	1) Height difference ¹⁾ is 15~30m or 2) Distance ²⁾ is 50~110m																			

¹⁾ Height difference : The difference of the height between the corresponding indoor unit and the indoor unit installed at the lowest place.
For example, When the indoor unit is installed 40m higher than the indoor unit installed at the lowest place, select the option "1".

²⁾ Distance : The difference between the pipe length of the indoor unit installed at the farthest place from an outdoor unit and the pipe length of the corresponding indoor unit from an outdoor unit.
For example, when the farthest pipe length is 100m and the corresponding indoor unit is 40m away from an outdoor unit, select the option "2". (100 - 40 = 60m)

SEG 3, 4, 5, 6, 8, 9 additional information

When the SEG 3 is set as "1" and follow Auto Change Over for HR only operation, it will operate as follows.

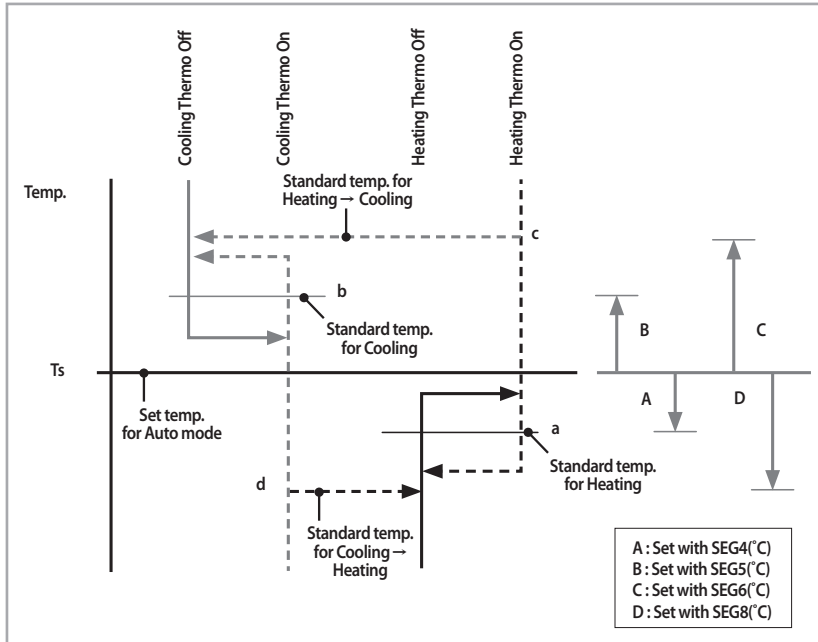

Cooling/Heating mode can be changed when Thermo Off status is maintained during the time with SEG9.

Changing a particular option

You can change each digit of set option.

Option	SEG1	SEG2	SEG3	SEG4	SEG5	SEG6						
Explanation	PAGE	MODE	The option mode you want to change	The tens' digit of an option SEG you will change	The unit digit of an option SEG you will change	Changed value						
Remote Controller Display												
Indication and Details	Indication	Details	Indication	Details	Indication	Details	Indication	Details	Indication	Details	Indication	Details
	0		D	Option mode	1~6	Tens' digit of SEG	0~9	Unit digit of SEG	0~9	The changed value	0~F	

- Note**
- When changing a digit of an indoor unit address setting option, set the SEG3 as 'A'.
 - When changing a digit of indoor unit installation option, set the SEG3 as '2'.

Ex) When setting the 'buzzer control' into disuse status.

Option	SEG1	SEG2	SEG3	SEG4	SEG5	SEG6
Explanation	PAGE	MODE	The option mode you want to change	The tens' digit of an option SEG you will change	The unit digit of an option SEG you will change	Changed value
Indication	0	D	2	1	7	1

QUESTIONS OR COMMENTS?

COUNTRY	CALL	OR VISIT US ONLINE AT	COUNTRY	CALL	OR VISIT US ONLINE AT
AUSTRIA	0810 - SAMSUNG (7267864, € 0.07/min)	www.samsung.com	TADJIKISTAN	8-10-800-500-55-500	www.samsung.com
BELGIUM	02-201-24-18	www.samsung.com/be (Dutch) www.samsung.com/be_fr (French)	MONGOLIA	+7-800-555-55-55	www.samsung.com
BOSNIA	05 133 1999	www.samsung.com	UKRAINE	0-800-502-000	www.samsung.com/ua (Ukrainian) www.samsung.com/ua_ru (Russian)
BULGARIA	07001 33 11 , normal tariff	www.samsung.com	BELARUS	810-800-500-55-500	www.samsung.com
CROATIA	062 SAMSUNG (062 726 7864)	www.samsung.com	MOLDOVA	0-800-614-40	www.samsung.com
CZECH	800 - SAMSUNG (800-726786)	www.samsung.com	U.A.E	800-SAMSUNG (726-7864)	www.samsung.com
DENMARK	70 70 19 70	www.samsung.com	OMAN	800-SAMSUNG(726-7864)	www.samsung.com/ae (English) www.samsung.com/ae_ar (Arabic)
FINLAND	09 85635050	www.samsung.com	KUWAIT	183-2255	www.samsung.com/ae (English) www.samsung.com/ae_ar (Arabic)
FRANCE	01 48 63 00 00	www.samsung.com	BAHRAIN	8000-4726	www.samsung.com/ae (English) www.samsung.com/ae_ar (Arabic)
GERMANY	0180 5 SAMSUNG bzw. 0180 5 7267864* (*0,14 €/Min. aus dem dt. Festnetz, aus dem Mobilfunk max. 0,42 €/Min.)	www.samsung.com	EGYPT	08000-726786	www.samsung.com
CYPRUS	8009 4000 only from landline (+30) 210 6897691 from mobile and land line	www.samsung.com	JORDAN	800-22273 065777444	www.samsung.com
GREECE	80111-SAMSUNG (80111 726 7864) only from land line (+30) 210 6897691 from mobile and land line	www.samsung.com	IRAN	021-8255	www.samsung.com
HUNGARY	06-80-SAMSUNG(726-7864)	www.samsung.com	MOROCCO	080 100 2255	www.samsung.com
ITALIA	800-SAMSUNG(726-7864)	www.samsung.com	SAUDI ARABIA	9200-21230	www.samsung.com/ae (English) www.samsung.com/ae_ar (Arabic)
LUXEMBURG	261 03 710	www.samsung.com	TURKEY	444 77 11	www.samsung.com
MACEDONIA	023 207 777	www.samsung.com	ARGENTINE	0800-333-3733	www.samsung.com
MONTENEGRO	020 405 888	www.samsung.com	BRAZIL	0800-124-421 4004-0000	www.samsung.com
NETHERLANDS	0900-SAMSUNG (0900-7267864) (€ 0,10/Min)	www.samsung.com	CHILE	800-SAMSUNG(726-7864) From mobile 02-482 82 00	www.samsung.com
NORWAY	815 56480	www.samsung.com	BOLIVIA	800-10-7260	www.samsung.com
POLAND	0 801-1SAMSUNG(172-678) +48 22 607-93-33	www.samsung.com	COLOMBIA	01-8000112112	www.samsung.com
PORTUGAL	808 20-SAMSUNG(808 20 7267)	www.samsung.com	COSTA RICA	0-800-507-7267	www.samsung.com/latin (Spanish) www.samsung.com/latin_en (English)
ROMANIA	08008 SAMSUNG (08008 726 7864) TOLL FREE No.	www.samsung.com	DOMINICA	1-800-751-2676	www.samsung.com/latin (Spanish) www.samsung.com/latin_en (English)
SERBIA	0700 Samsung (0700 726 7864)	www.samsung.com	ECUADOR	1-800-10-7267	www.samsung.com/latin (Spanish) www.samsung.com/latin_en (English)
SLOVAKIA	0800 - SAMSUNG(0800-726 786)	www.samsung.com	EL SALVADOR	800-6225	www.samsung.com/latin (Spanish) www.samsung.com/latin_en (English)
SPAIN	902 - 1 - SAMSUNG (902 172 678)	www.samsung.com	GUATEMALA	1-800-299-0013	www.samsung.com/latin (Spanish) www.samsung.com/latin_en (English)
SWEDEN	0771 726 7864 (SAMSUNG)	www.samsung.com	HONDURAS	800-27919267	www.samsung.com/latin (Spanish) www.samsung.com/latin_en (English)
SWITZERLAND	0848 - SAMSUNG(7267864, CHF 0.08/min)	www.samsung.com/ch (German) www.samsung.com/ch_fr (French)	JAMAICA	1-800-234-7267	www.samsung.com
U.K	0330 SAMSUNG (7267864)	www.samsung.com	NICARAGUA	00-1800-5077267	www.samsung.com/latin (Spanish) www.samsung.com/latin_en (English)
EIRE	0818 717100	www.samsung.com	PANAMA	800-7267	www.samsung.com/latin (Spanish) www.samsung.com/latin_en (English)
LITHUANIA	8-800-77777	www.samsung.com	PERU	0-800-777-08	www.samsung.com
LATVIA	8000-7267	www.samsung.com	PUERTO RICO	1-800-682-3180	www.samsung.com
ESTONIA	800-7267	www.samsung.com	TRINIDAD & TOBAGO	1-800-SAMSUNG(726-7864)	www.samsung.com
RUSSIA	8-800-555-55-55	www.samsung.com	VENEZUELA	0-800-100-5303	www.samsung.com
GEORGIA	0-800-555-555	www.samsung.com	PHILIPPINES	1-800-10-SAMSUNG(726-7864) for PLDT 1-800-3-SAMSUNG(726-7864) for Digitel 1-800-8-SAMSUNG(726-7864) for Globe 02-5805777	www.samsung.com
ARMENIA	0-800-05-555	www.samsung.com			
AZERBAIJAN	088-55-55-555	www.samsung.com			
KAZAKHSTAN	8-10-800-500-55-500(GSM: 7799)	www.samsung.com			
UZBEKISTAN	8-10-800-500-55-500	www.samsung.com			
KYRGYZSTAN	00-800-500-55-500	www.samsung.com			

"EEE Yönetmeliğine Uygundur"
"This EEE is compliant with RoHS"