

DIGITAL INPUT/OUTPUT RELAY INTERFACE

BMS-IFDD02E2

- Thank you very much for purchasing this TOSHIBA Digital Input/Output Relay Interface.
- Please read this manual carefully beforehand for proper installation of the relay interface.

CONTENTS

Precautions for Safety	1
Introduction	2
Before Installation	3
1 Installation.....	4
2 Connection of Power cables/Earth wires/Singl wires	5
3 Setting	8
4 Trial Operation Check	9

Precautions for Safety

- Read these “Precautions for Safety” carefully before installation.
- The precautions described below include important items regarding safety. Observe them without fail.
- After the installation work, perform a trial operation to check for any problem. Follow the Owner's Manual to explain how to use and maintain the unit to the customer. Ask the customer to keep this Installation Manual together with the Owner's Manual.

WARNING

- **Ask an authorized dealer or qualified installation professional to install or reinstall the relay interface.**
Improper installation may result in electric shock or fire.
- **Turn off the main power supply switch or breaker before attempting any electrical work.**
Make sure all power switches are off. Failure to do so may cause electric shock.
- **Perform installation work properly according to this Installation Manual.**
Improper installation may result in electric shock or fire.
- **Do not modify the unit.**
Any modification may cause a malfunction, resulting in overheating or fire.

CAUTION

- **Perform wiring correctly in accordance with specified the current capacity.**
Failure to do so may result in short-circuiting, overheating, or fire.
- **Connect the specified cables for the terminals securely to prevent external forces from affecting them.**
Failure to do so may result in disconnection, overheating, or fire.

Introduction

Applications/Functions/Specifications

• Applications

The Digital Input/Output Relay Interface is used to control air conditioners by interlocking them with electric lock signals and fire alarm signals, and to transmit air conditioner failures to other devices.

• Functions

The Digital Input/Output Relay Interface connects non-voltage contact signals, transmits their input status to the Touch Screen Controller, and outputs signals from the contacts (open collector) according to the command from the Touch Screen Controller.

• Specifications

Power supply	220 - 240 V, AC 50/60 Hz
Power consumption	6.5 W
Operating temperature/ humidity	0 to 40 °C, 10 to 90% RH
Storage temperature	-20 to +60 °C
Chassis material	Galvanized sheet metal 0.8t (no coating)
Dimensions	66(H) x 193(W) x 246(D) mm
Mass	1.65 kg

Digital input	Input type	Photo-coupler insulation
	Input points	8 points
	Input resistance	9 k ohm
	Input "ON" current	1 mA
Digital output	Output type	Open collector
	Output points	4 points
	Output current	Max. 35 mA (per point)
	Output voltage	Less than DC 24V
External power supply for Input/Output		DC 12 V, 120 mA

External View

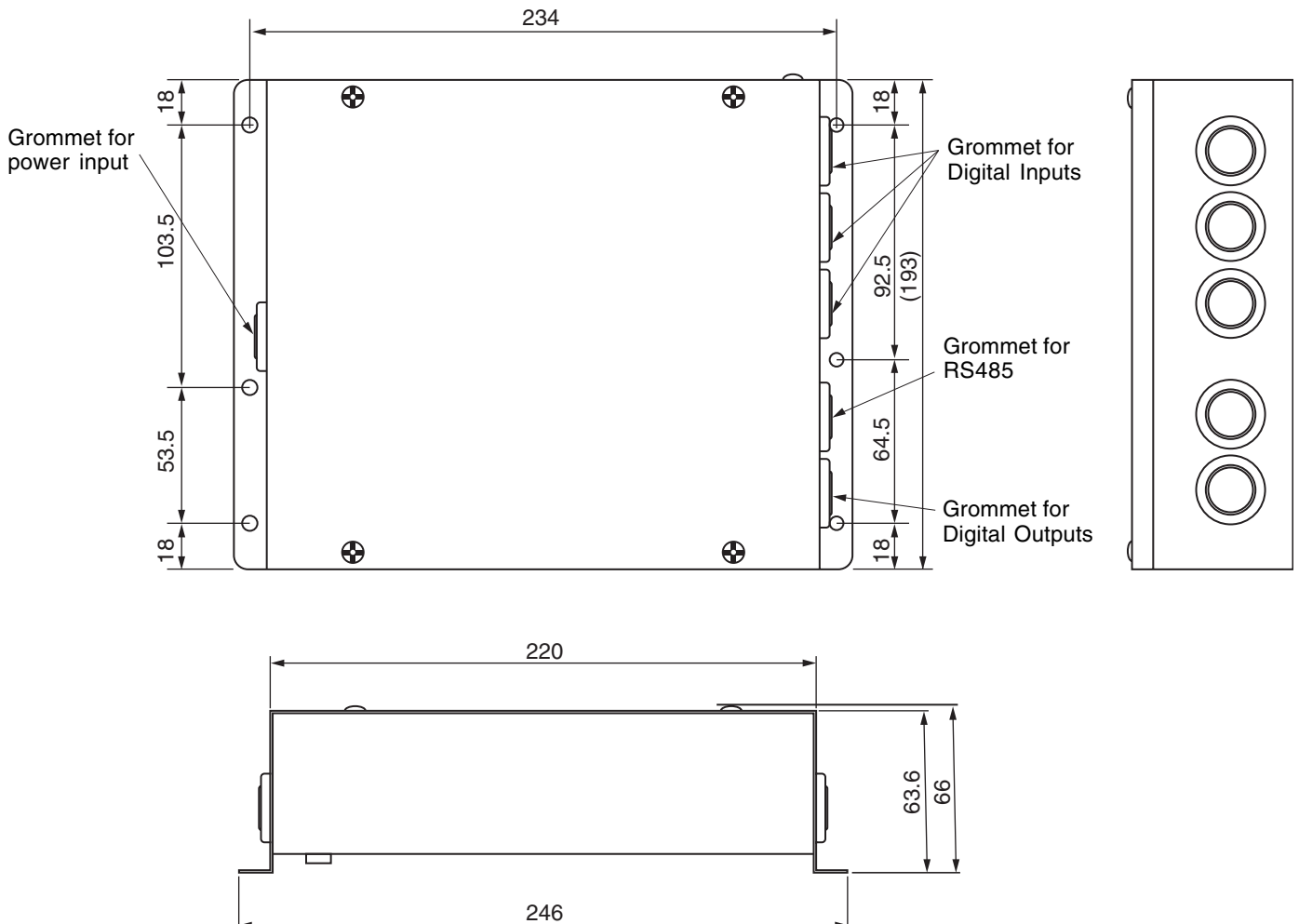

Before Installation

Check the following package contents.

No.	Item	Quantity	Remarks
1	DIGITAL INPUT/OUTPUT RELAY INTERFACE	1	
2	Installation Manual	1	
3	Screw	4	M4 x 12mm tapping screws
4	Pin terminal	2	

Use the following wiring materials to connect signal lines and power lines. (Procured on site.)

No.	Line	Description	
1	For RS-485	Type	2-core shield wire
		Wire size	1.25mm ² , 500m max. (total length)
		Length	
2	For digital Input/Output connection	Type	2-core wire, 0.3mm ² , 100m max.
		Wire size	
		Length	
3	For power	Type	H07 RN-F or 245IEC66
		Wire size	0.75mm ² , 50 m max.

1 Installation

Digital Input/Output Relay Interface Installation Method and Orientation

There are five installation methods for this relay interface as shown below, surface mount or wall mount. Use the attached screws.

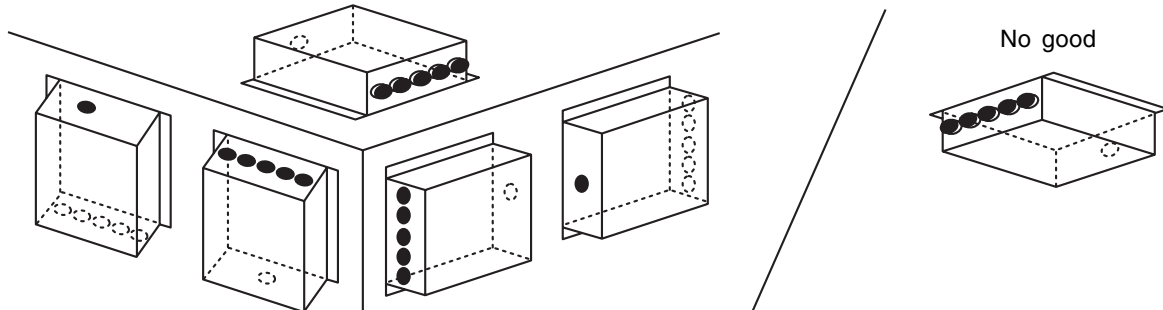

REQUIREMENT

Do not install the unit in any of the following places.

- Humid or wet place
- Dusty place
- Place exposed to direct sunlight
- Place where there is a TV set or radio within one meter
- Place exposed to rain (outdoors, under eaves, etc.)

Installation Space and Maintenance Space

A side space for connecting through cable inlets and an upper space for maintenance must be reserved before installation.

The other sides can be adjacent to surrounding objects.

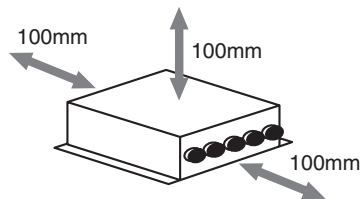

2 Connection of Power cables/Earth wires/ Signal wires

⚠ CAUTION

The RS-485 signal wire has polarity. Connect A to A, and B to B. If connected with incorrect polarity, the unit will not work.

REQUIREMENT

Disconnect the appliance from the main power supply.

This appliance must be connected to the main power supply by a circuit breaker or switch with a contact separation of at least 3mm.

Power cables/Earth wires/Signal wires

Connect power cables, earth wires, and signal wires to the specified terminals on the terminal block.

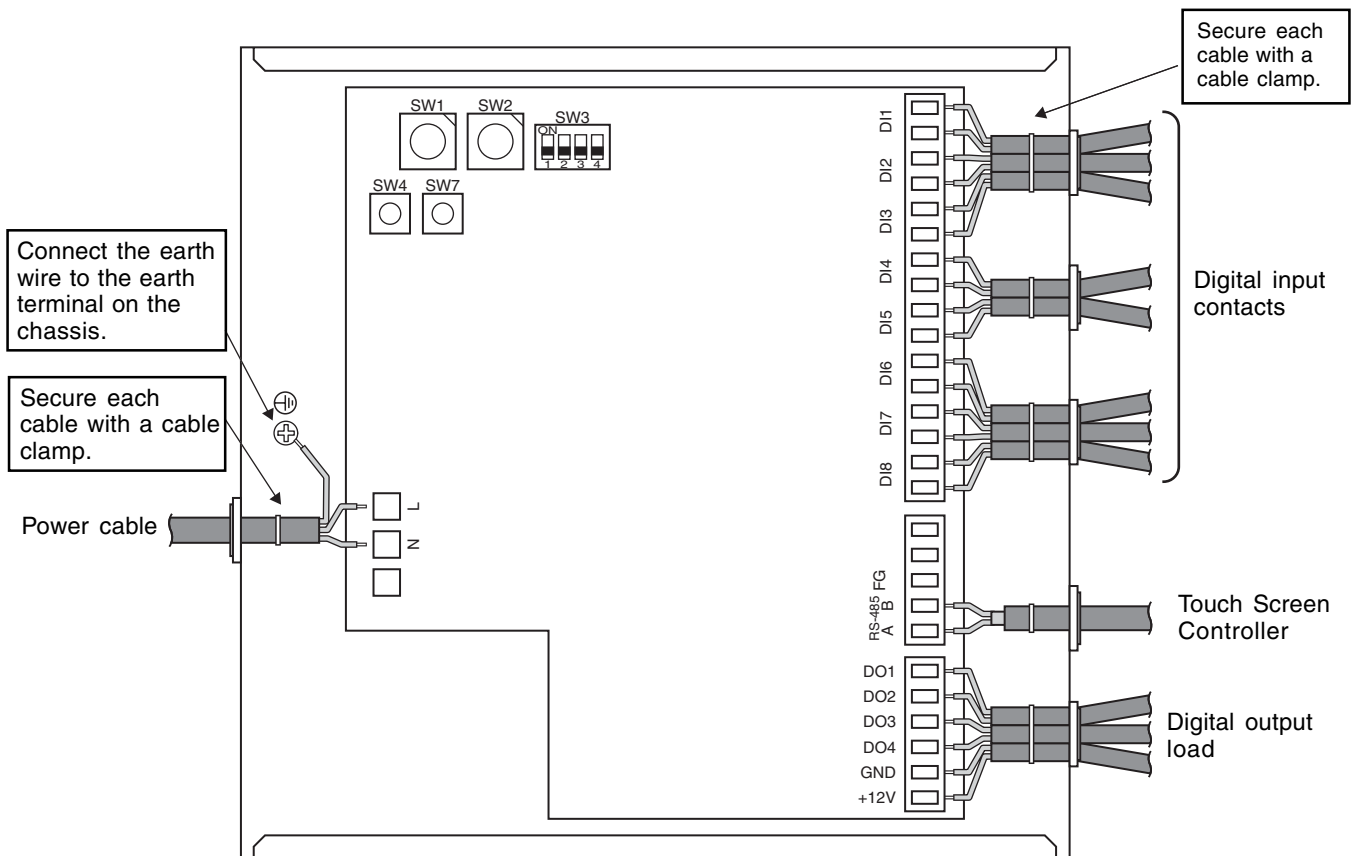

Length of stripped power cable

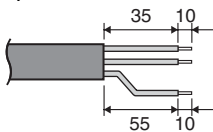

Length of stripped communication wire

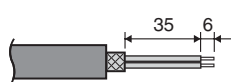

Length of stripped digital Input/Output connector wire

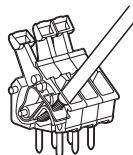
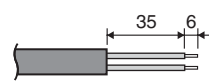

Insert the wire by pushing the lever with a screwdriver. Check that the wire is inserted securely.



When inserting two RS-485 communication cables into a single terminal for connection to another interface, crimp them using the attached pin terminal.

2 Connection of Power cables/Earth wires/ Signal wires (continued)

Wiring Connection

⚠ CAUTION

If an inductive load (relay coil) or a bulb is connected, a surge voltage or rush current will be generated. Take adequate measures against surge voltage or rush current.

The following describes wiring connections of the Digital Input/Output Relay Interface when it is used in the air conditioner control system.

• Terminator resistor setting

Set the RS-485 terminator resistor by the TCS-NET Relay Interface.
Do not set it by the Digital Input/Output Relay Interface.

• Shield earthing

The shield earth of the RS-485 signal wires should be single-point earth. Earth the wires on the Touch Screen Controller.

Other shield lines should be closed, and the terminal end should be open and insulated.

• Connection of external digital inputs

Input circuit examples are shown below (electrically isolated using a photo-coupler).

(1) Example of contact input connection

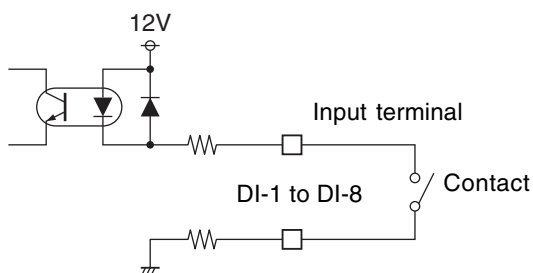

(2) Example of current sink connection

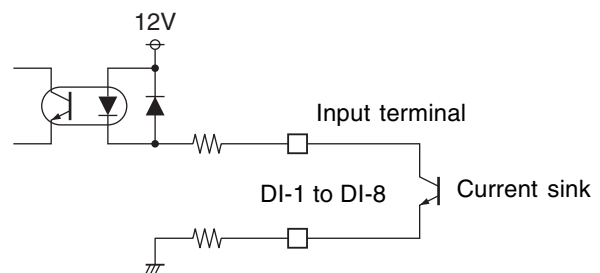

• Connection of external digital outputs

Output circuit examples are shown below (open collector output electrically isolated using a photo-coupler).

(1) Example of load connection

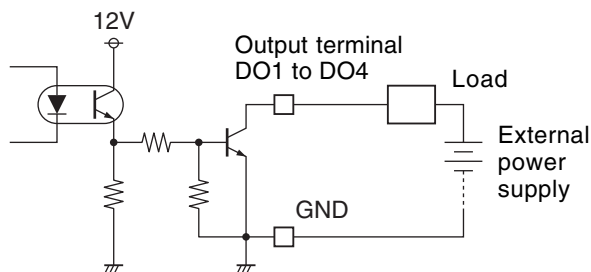

(2) Example of load connection

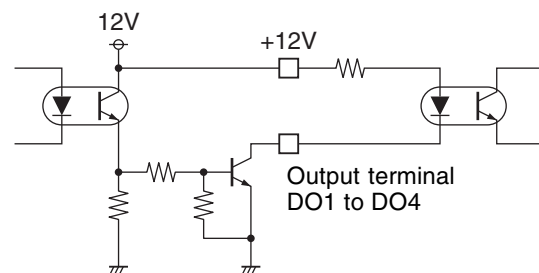

2 Connection of Power cables/Earth wires/ Signal wires (continued)

Connection diagram

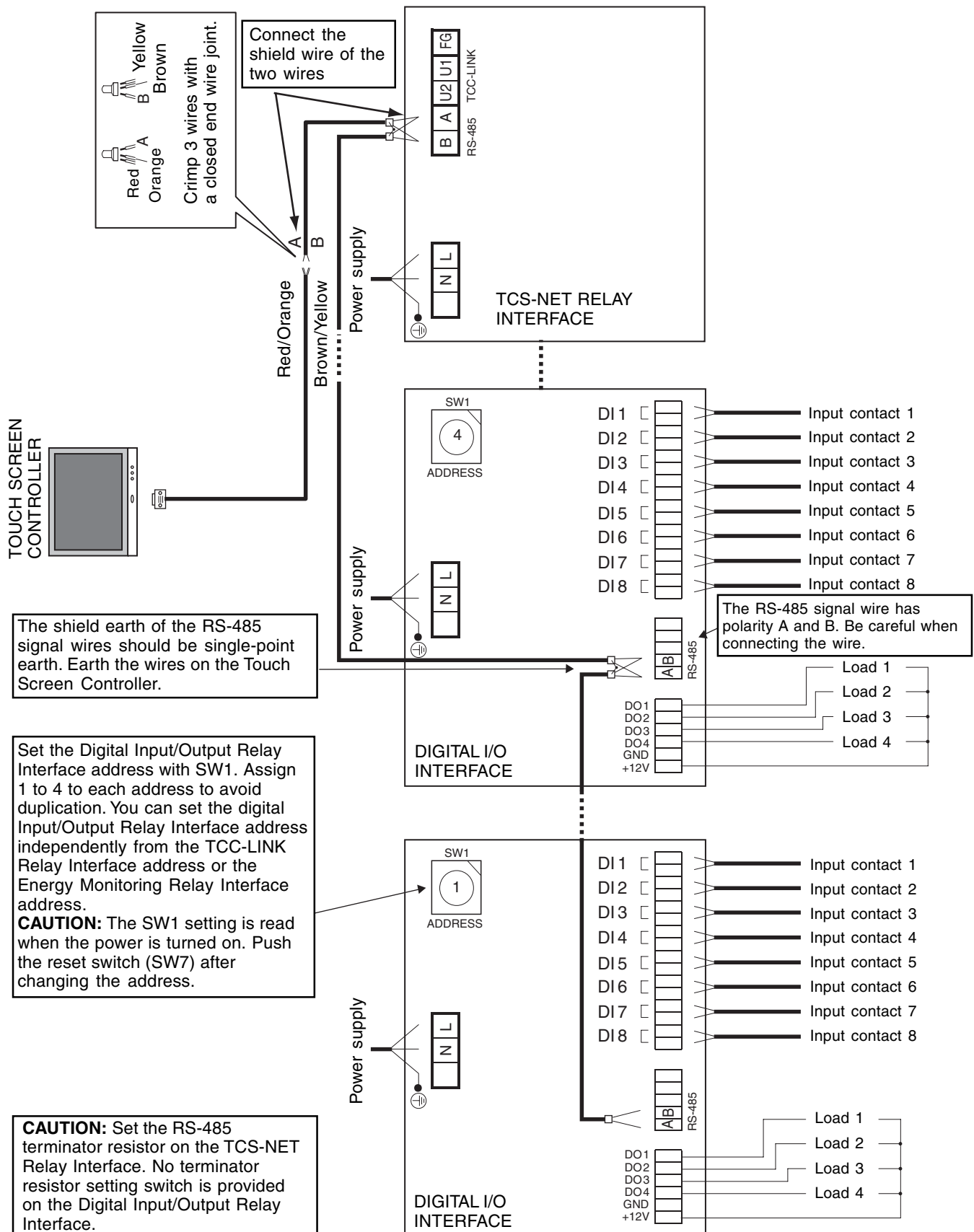

3 Setting

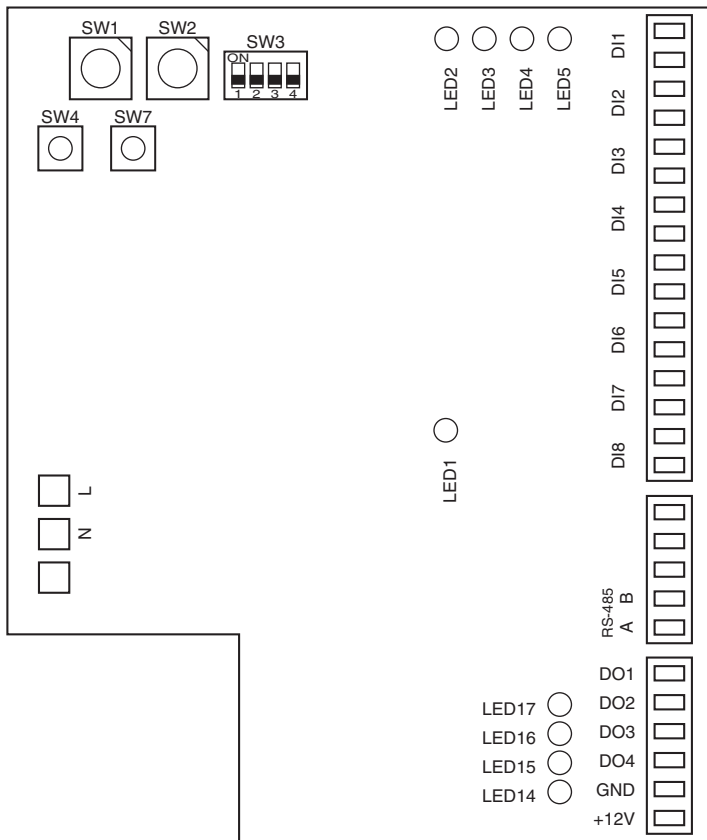

SW1	Address set switch	
	1 - 4	Address
	0,5 - F	Not used
SW2	Operating mode set switch (0 usually)	
SW3	Test switch (all OFF usually)	
SW4	Test switch	
SW7	Reset switch	
LED1	Power indicator	
LED2	RS-485 communication status indicator	
LED3	Not used	
LED4	Test indicator	
LED5	Test indicator	
LED14 - LED17	Digital output indicator	

The following settings are necessary to use Digital Input/Output Relay Interfaces.

- SW1 Address set switch
When two or more Digital Input/Output Relay Interfaces are used, set a different address for each unit to avoid address duplication.
Assign addresses in ascending order.

⚠ CAUTION

- Set relay interface addresses according to the air conditioner address table.
- When the SW1 setting has been changed, push the reset switch SW7. The new address setting is read.

- SW2 Operation mode set switch
 - SW3 Test switch
 - SW4 Test switch
 - SW7 Reset switch
-] These switches are not used during normal operation. Set zero (0) or "all OFF".
- When performing address setting with SW1, push this reset switch after address setting to read the set value.

4 Trial Operation Check

Before starting trial operation

Turn on the power of the Digital Input/Output Relay Interface after all cable connections and settings are completed. Turn on power of the air conditioning control system.

Trial operation

• Confirming external input connection

In the test mode, when the external inputs connected to the input terminals DI-1 to DI-8 are ON, the respective LEDs will go on so you can confirm the connection.

Confirming procedure:

Set the operation mode switch SW2 to “3”, and push the reset switch SW7 to enter the test mode. Unless SW4 is pushed, the respective input status of DI-1 to DI-4 is indicated by LED2 to LED5. When SW4 is pushed, the respective input status of DI-5 to DI-8 is indicated by LED2 to LED5.
 (*) To return to the normal operation, reset SW2 to “zero (0)” and push SW7.

	LED2	LED3	LED4	LED5
SW4 OFF	Displays DI-1 input status.	Displays DI-2 input status.	Displays DI-3 input status.	Displays DI-4 input status.
SW4 ON	Displays DI-5 input status.	Displays DI-6 input status.	Displays DI-7 input status.	Displays DI-8 input status.

Input ON: LED lights
 Input OFF: LED turns off

• Checking external output connection

In the test mode, you can set output terminals DO1 to DO4 to ON or OFF with the test switch. Their output status is indicated by each LED.

Checking procedure:

Set the operation mode switch SW2 to “3” in the same way as the external input check, and then push the reset switch SW7 to enter the test mode. When the bit of the test switch SW3 is set to ON, the external output turns ON; when set to OFF, the external output turns OFF. Bits 1 to 4 of SW3 correspond to output terminals DO1 to DO4. The respective output status of output terminals DO1 to DO4 is indicated by LED14 to LED17. The LEDs light with the output ON, and go off with the output OFF.
 (*) To return to normal operation, reset SW2 to “zero (0)” and push SW7.

LED14	LED15	LED16	LED17
Displays DO1 output status.	Displays DO2 output status.	Displays DO3 output status.	Displays DO4 output status.

Output ON: LED lights
 Output OFF: LED turns off

• Checking the RS-485 communication status

Use LED2 for checking the RS-485 communication status.

When RS-485 communication with Touch Screen Controller is normal, LED2 will blink.

		Normal	Abnormal
LED1	Power indicator	ON	OFF
LED2	RS-485 communication status indicator	Blinking	OFF
LED3	Not used	OFF	—
LED4	Test indicator	OFF	—
LED5	Test indicator	OFF	—

Memo

